

BLF 5.08HC/18/180F SN BK BX PRT

Weidmüller Interface GmbH & Co. KG
 Klingenbergstraße 26
 D-32758 Detmold
 Germany

www.weidmueller.com

Product image

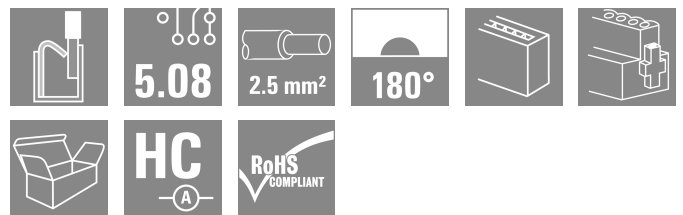

Similar to illustration

Just as reliable as the millionfold proven original and featuring innovative details:

The BLF 5.08HC PUSH IN version of the BLZP 5.08HC female connector is not only different in terms of connection system; it also has a more compact design. Weidmüller's innovative PUSH IN spring connection system stands for the future of easy and tool-free wire connection. HC = High Current.

In terms of versatility, the BLF 5.08HC offers just as much as the version which served as a model:

- 3 tested-and-proven wire outlet directions provide the usual flexibility for application-specific design
- 4 flange variations and the patented release latch allow the locking concept to be based on the requirements of the user
- Use the BLF 5.08HC and SL 5.08HC plug combination to reach the max. rated specifications

General ordering data

Version	PCB plug-in connector, female plug, 5.08 mm, Number of poles: 18, 180°, PUSH IN with actuator, Clamping range, max. : 3.31 mm², Box
Order No.	2441660000
Type	BLF 5.08HC/18/180F SN BK BX PRT
GTIN (EAN)	4050118455571
Qty.	18 items
Product data	IEC: 400 V / 24 A / 0.2 - 2.5 mm² UL: 300 V / 18.5 A / AWG 26 - AWG 12
Packaging	Box

BLF 5.08HC/18/180F SN BK BX PRT

Weidmüller Interface GmbH & Co. KG
Klingenbergstraße 26
D-32758 Detmold
Germany

www.weidmueller.com

Technical data

Approvals

Approvals



ROHS Conform
UL File Number Search [UL Website](#)
Certificate No. (cURus) E60693

Dimensions and weights

Depth	27.7 mm	Depth (inches)	1.0905 inch
Height	14.2 mm	Height (inches)	0.5591 inch
Width	101.24 mm	Width (inches)	3.9858 inch
Net weight	32.79 g		

Environmental Product Compliance

RoHS Compliance Status	Compliant without exemption		
REACH SVHC	No SVHC above 0.1 wt%		
Product Carbon Footprint	Cradle to gate	2,626 kg CO2 eq.	

System Parameters

Product family	OMNIMATE Signal - series BL/SL 5.08		
Type of connection	Field connection		
Wire connection method	PUSH IN with actuator		
Pitch in mm (P)	5.08 mm		
Pitch in inches (P)	0.200 "		
Conductor outlet direction	180°		
Number of poles	18		
L1 in mm	86.36 mm		
L1 in inches	3.400 "		
Number of rows	1		
Pin series quantity	1		
Rated cross-section	2.5 mm ²		
Touch-safe protection acc. to DIN VDE 57 106	Safe from finger touch		
Touch-safe protection acc. to DIN VDE 0470	IP20 plugged/ IP10 unplugged		
Protection degree	IP20		
Volume resistance	≤5 mΩ		
Can be coded	Yes		
Stripping length	10 mm		
Screwdriver blade	0.6 x 3.5		
Screwdriver blade standard	DIN 5264		
Plugging cycles	25		
Plugging force/pole, max.	7 N		
Pulling force/pole, max.	5.5 N		
Tightening torque	Torque type	Screw flange	
	Usage information	Tightening torque	min. 0.2 Nm max. 0.25 Nm

Material data

Insulating material	PBT	Colour	black
Colour of operational elements	orange	Colour chart (similar)	RAL 9011

BLF 5.08HC/18/180F SN BK BX PRT

Weidmüller Interface GmbH & Co. KG
 Klingenbergstraße 26
 D-32758 Detmold
 Germany

www.weidmueller.com

Technical data

Insulating material group	IIIa	Comparative Tracking Index (CTI)	≥ 200
Moisture Level (MSL)		UL 94 flammability rating	V-0
Contact material	Cu-alloy	Contact surface	tinned
Layer structure of plug contact	4...8 µm Sn hot-dip tinned	Storage temperature, min.	-40 °C
Storage temperature, max.	70 °C	Operating temperature, min.	-50 °C
Operating temperature, max.	100 °C	Temperature range, installation, min.	-30 °C
Temperature range, installation, max.	100 °C		

Conductors suitable for connection

Clamping range, min.	0.13 mm ²
Clamping range, max.	3.31 mm ²
Wire connection cross section AWG, min.	AWG 26
Wire connection cross section AWG, max.	AWG 12
Solid, min. H05(07) V-U	0.2 mm ²
Solid, max. H05(07) V-U	2.5 mm ²
Flexible, min. H05(07) V-K	0.2 mm ²
Flexible, max. H05(07) V-K	2.5 mm ²
w. plastic collar ferrule, DIN 46228 pt 4, min.	0.25 mm ²
w. plastic collar ferrule, DIN 46228 pt 4, max.	2.5 mm ²
w. wire end ferrule, DIN 46228 pt 1, min.	0.25 mm ²
w. wire end ferrule, DIN 46228 pt 1, max.	2.5 mm ²
Plug gauge in accordance with EN 60999 a x b; ø	2.8 mm x 2.0 mm

Clampable conductor	Cross-section for conductor connection	Type	fine-wired
		nominal	0.5 mm ²
wire end ferrule	wire end ferrule	Stripping length	nominal 12 mm
		Recommended wire-end ferrule	H0,5/16 OR
		Stripping length	nominal 10 mm
		Recommended wire-end ferrule	H0,5/10
Cross-section for conductor connection	wire end ferrule	Type	fine-wired
		nominal	0.75 mm ²
		Stripping length	nominal 12 mm
		Recommended wire-end ferrule	H0,75/16 W
Cross-section for conductor connection	wire end ferrule	Stripping length	nominal 10 mm
		Recommended wire-end ferrule	H0,75/10
		Type	fine-wired
		nominal	1 mm ²
Cross-section for conductor connection	wire end ferrule	Stripping length	nominal 12 mm
		Recommended wire-end ferrule	H1,0/16D R
		Stripping length	nominal 10 mm
		Recommended wire-end ferrule	H1,0/10
Cross-section for conductor connection	wire end ferrule	Type	fine-wired
		nominal	1.5 mm ²
		Stripping length	nominal 10 mm
		Recommended wire-end ferrule	H1,5/10
		Stripping length	nominal 12 mm

BLF 5.08HC/18/180F SN BK BX PRT

Weidmüller Interface GmbH & Co. KG
 Klingenbergstraße 26
 D-32758 Detmold
 Germany

www.weidmueller.com

Technical data

		Recommended wire-end ferrule	H1.5/16 R
Cross-section for conductor connection	Type	fine-wired	
	nominal	2.5 mm ²	
wire end ferrule	Stripping length	nominal	10 mm
	Recommended wire-end ferrule	H2.5/10	
	Stripping length	nominal	10 mm
	Recommended wire-end ferrule	H2.5/14DS BL	
Reference text	The outside diameter of the plastic collar should not be larger than the pitch (P), Length of ferrules is to be chosen depending on the product and the rated voltage.		

Rated data acc. to IEC

tested acc. to standard	IEC 60664-1, IEC 61984	Rated current, min. number of poles (Tu=20°C)	24 A
Rated current, max. number of poles (Tu=20°C)	19 A	Rated current, min. number of poles (Tu=40°C)	21 A
Rated current, max. number of poles (Tu=40°C)	16.5 A	Rated voltage for surge voltage class / pollution degree II/2	400 V
Rated voltage for surge voltage class / pollution degree III/2	320 V	Rated voltage for surge voltage class / pollution degree III/3	250 V
Rated impulse voltage for surge voltage class/ pollution degree II/2	4 kV	Rated impulse voltage for surge voltage class/ pollution degree III/2	4 kV
Rated impulse voltage for surge voltage class/ contamination degree III/3	4 kV	Short-time withstand current resistance	3 x 1s with 120 A

Rated data acc. to CSA

Rated voltage (Use group B / CSA)	300 V	Rated voltage (Use group D / CSA)	300 V
Rated current (Use group D / CSA)	10 A	Wire cross-section, AWG, min.	AWG 26
Wire cross-section, AWG, max.	AWG 12		

Rated data acc. to UL 1059

Institute (cURus)	CURUS	Certificate No. (cURus)	E60693
Rated voltage (Use group B / UL 1059)	300 V	Rated voltage (Use group D / UL 1059)	300 V
Rated current (Use group B / UL 1059)	18.5 A	Rated current (Use group D / UL 1059)	10 A
Wire cross-section, AWG, min.	AWG 26	Wire cross-section, AWG, max.	AWG 12
Reference to approval values	Specifications are maximum values, details - see approval certificate.		

Packing

Packaging	Box	VPE length	351.00 mm
VPE width	135.00 mm	VPE height	38.00 mm

Type tests

Test: Durability of markings	Standard	DIN EN 61984 section 7.3.2 / 09.02 taking pattern from DIN EN 60068-2-70 / 07.96
	Test	mark of origin, type identification, pitch, type of material, date clock
	Evaluation	available
	Test	durability
	Evaluation	passed
Test: Misengagement (Non-interchangeability)	Standard	DIN EN 61984 section 6.3 and 6.9.1 / 09.02, DIN EN 60512-13-5 / 11.08

BLF 5.08HC/18/180F SN BK BX PRT

Weidmüller Interface GmbH & Co. KG
 Klingenbergstraße 26
 D-32758 Detmold
 Germany

www.weidmueller.com

Technical data

	Test	180° turned with coding elements	
	Evaluation	passed	
	Test	visual examination	
	Evaluation	passed	
Test: Clampable cross section	Standard	DIN EN 60999-1 section 7 and 9.1 / 12.00, DIN EN 60947-1 section 8.2.4.5.1 / 04.08	
	Conductor type	Type of conductor and conductor cross-section	solid 0.2 mm ²
		Type of conductor and conductor cross-section	stranded 0.2 mm ²
		Type of conductor and conductor cross-section	solid 2.5 mm ²
		Type of conductor and conductor cross-section	stranded 2.5 mm ²
		Type of conductor and conductor cross-section	AWG 26/1
		Type of conductor and conductor cross-section	AWG 26/19
		Type of conductor and conductor cross-section	AWG 14/1
		Type of conductor and conductor cross-section	AWG 14/19
	Evaluation	passed	
Test for damage to and accidental loosening of conductors	Standard	DIN EN 60999-1 section 9.4 / 12.00	
	Requirement	0.2 kg	
	Conductor type	Type of conductor and conductor cross-section	AWG 26/1
		Type of conductor and conductor cross-section	AWG 26/19
	Evaluation	passed	
	Requirement	0.3 kg	
	Conductor type	Type of conductor and conductor cross-section	H05V-U0.5
		Type of conductor and conductor cross-section	H05V-K0.5
	Evaluation	passed	
	Requirement	0.7 kg	
Conductor type	Type of conductor and conductor cross-section	H07V-U2.5	
	Type of conductor and conductor cross-section	H07V-K2.5	
Evaluation	passed		
Requirement	0.9 kg		
Conductor type	Type of conductor and conductor cross-section	AWG 12/1	
	Type of conductor and conductor cross-section	AWG 12/19	

BLF 5.08HC/18/180F SN BK BX PRT

Weidmüller Interface GmbH & Co. KG
 Klingenbergstraße 26
 D-32758 Detmold
 Germany

www.weidmueller.com

Technical data

Pull-out test	Evaluation	passed		
	Standard	DIN EN 60999-1 section 9.5 / 12.00		
	Requirement	≥10 N		
	Conductor type	Type of conductor and conductor cross-section	AWG 26/1	
		Type of conductor and conductor cross-section	AWG 26/19	
	Evaluation	passed		
	Requirement	≥20 N		
	Conductor type	Type of conductor and conductor cross-section	H05V-K0.5	
		Type of conductor and conductor cross-section	H05V-U0.5	
	Evaluation	passed		
	Requirement	≥50 N		
	Conductor type	Type of conductor and conductor cross-section	H07V-U2.5	
		Type of conductor and conductor cross-section	H07V-K2.5	
	Evaluation	passed		
	Requirement	≥60 N		
	Conductor type	Type of conductor and conductor cross-section	AWG 12/1	
		Type of conductor and conductor cross-section	AWG 12/19	
	Evaluation	passed		

Important note

IPC conformity Conformity: The products are developed, manufactured and delivered according international recognized standards and norms and comply with the assured properties in the data sheet resp. fulfill decorative properties in accordance with IPC-A-610 "Class 2". Further claims on the products can be evaluated on request.

- Notes
- Additional variants on request
 - Gold-plated contact surfaces on request
 - Rated current related to rated cross-section & min. No. of poles.
 - Wire end ferrule without plastic collar to DIN 46228/1
 - Wire end ferrule with plastic collar to DIN 46228/4
 - P on drawing = pitch
 - Crimping shape "A" for wire end ferrules with PZ 6/5 crimping tool recommended.
 - The test point can only be used as potential-pickup point.
 - In accordance with IEC 61984, OMNIMATE-connectors are connectors without breaking capacity (COC). During designated use, connectors are not allowed to be engaged or disengaged when live or under load
 - Long term storage of the product with average temperature of 50 °C and maximum humidity 70%, 36 months

Classifications

ETIM 8.0	EC002638	ETIM 9.0	EC002638
ETIM 10.0	EC002638	ECLASS 14.0	27-46-02-02
ECLASS 15.0	27-46-02-02		

BLF 5.08HC/18/180F SN BK BX PRT

Weidmüller Interface GmbH & Co. KG
 Klingenbergstraße 26
 D-32758 Detmold
 Germany

www.weidmueller.com

Drawings

Dimensional drawing

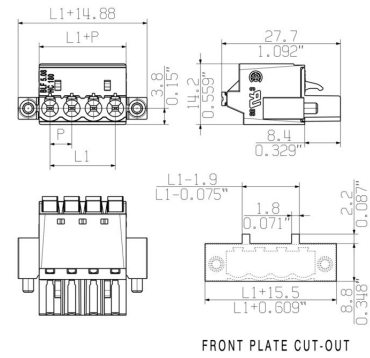

Graph



Graph



Uncompromising functionality High vibration resistance

Drawings

Product benefits



Solid PUSH IN contact Safe and durable

Product benefits



Cost-effective wiring Quick and intuitive operation

Product benefits



Wide clamping range Tool-free wire connection