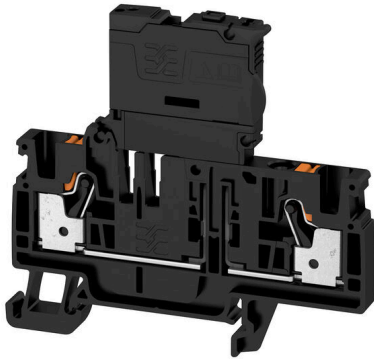

**AFS 4 2C BK****Weidmüller Interface GmbH & Co. KG**Klingenbergstraße 26  
D-32758 Detmold  
Germany

www.weidmueller.com

**Product image**

Fuse terminal blocks and component terminal blocks allow protective and functional elements to be integrated directly into the terminal strip. Fuse terminal blocks include built-in fuse holders to reliably protect electrical circuits against overload –ideal for control and distribution systems. Component terminal blocks make it possible to incorporate electronic components such as diodes, resistors, or LEDs directly into the wiring. This enables space-saving and clearly arranged implementation of switching functions and signal separation. Both types of terminal blocks ensure higher safety, easy maintenance, and a compact, function-oriented installation.

**General ordering data**

Version	Fuse terminal, PUSH IN, 4 mm <sup>2</sup> , 400 V, 6.3 A, black
Order No.	<a href="#">2429860000</a>
Type	AFS 4 2C BK
GTIN (EAN)	4050118439717
Qty.	50 items

## AFS 4 2C BK

**Weidmüller Interface GmbH & Co. KG**  
 Klingenbergstraße 26  
 D-32758 Detmold  
 Germany

www.weidmueller.com

## Technical data

### Approvals

Approvals



ROHS	Conform
UL File Number Search	<a href="#">UL Website</a>
Certificate No. (cURus)	E60693

### Dimensions and weights

Depth	68 mm	Depth (inches)	2.6772 inch
Depth including DIN rail	69 mm	Height	74 mm
Height (inches)	2.9134 inch	Width	6.1 mm
Width (inches)	0.2402 inch	Net weight	17.5 g

### Temperatures

Storage temperature	-25 °C...55 °C	Ambient temperature	-5 °C...40 °C
Continuous operating temp., min.	-60 °C	Continuous operating temp., max.	130 °C

### Environmental Product Compliance

RoHS Compliance Status	Compliant without exemption
REACH SVHC	No SVHC above 0.1 wt%

### Material data

Basic material	Wemid	Colour	black
UL 94 flammability rating	V-0		

### Rating data IECEx/ATEX

Certificate No. (ATEX)	TUEV17ATEX8064U	Certificate No. (IECEX)	IECEXTUR17.0030U
Max. voltage (ATEX)	250 V	Current (ATEX)	6.3 A
Wire cross section max. (ATEX)	4 mm <sup>2</sup>	Max. voltage (IECEX)	250 V
Current (IECEX)	6.3 A	Wire cross section max. (IECEX)	4 mm <sup>2</sup>
Marking EN 60079-7	Ex ec II C Gc	Ex 2014/34/EU label	II 3 G D

### System specifications

End cover plate required	Yes	Number of potentials	1
Number of levels	1	Number of clamping points per level	2
Number of potentials per tier	1	Levels cross-connected internally	Yes
PE connection	No	Mounting rail	TS 35
N-function	No	PE function	No
PEN function	No		

### Additional technical data

With snap-in pegs	No	Open sides	right
Snap-on	No	Type of fixing	Snap-on

## AFS 4 2C BK

**Weidmüller Interface GmbH & Co. KG**

Klingenbergstraße 26  
D-32758 Detmold  
Germany

www.weidmueller.com

## Technical data

Installation advice	Rail	Type of mounting	TS 35
---------------------	------	------------------	-------

### CSA rating data

Wire cross section max. (CSA)	10 AWG	Voltage size C (CSA)	150 V
Current size C (CSA)	10 A	Certificate No. (CSA)	200039-70089609
Voltage size B (CSA)	300 V	Current size B (CSA)	10 A
Voltage size D (CSA)	300 V	Current size D (CSA)	10 A
Wire cross section min. (CSA)	26 AWG		

### Conductors for clamping (additional connection)

Connection type, additional connection PUSH IN

### Conductors for clamping (rated connection)

Gauge to IEC 60947-1	A4		
Wire connection cross section AWG, max.	AWG 12		
Connection direction	top		
Stripping length	12 mm		
Type of connection 2	PUSH IN		
Type of connection	PUSH IN		
Number of connections	2		
Clamping range, max.	6 mm <sup>2</sup>		
Clamping range, min.	0.14 mm <sup>2</sup>		
Blade size	0.6 x 3.5 mm		
Wire connection cross section AWG, min.	AWG 26		
Wire connection cross-section, finely stranded with wire-end ferrules DIN 46228/4, max.	4 mm <sup>2</sup>		
Wire connection cross-section, finely stranded with wire-end ferrules DIN 46228/4, min.	0.14 mm <sup>2</sup>		
Wire connection cross-section, finely stranded with wire-end ferrules DIN 46228/1, max.	6 mm <sup>2</sup>		
Wire connection cross-section, finely stranded with wire-end ferrules DIN 46228/1, min.	0.14 mm <sup>2</sup>		
Wire connection cross section, finely stranded, max.	6 mm <sup>2</sup>		
Wire connection cross section, finely stranded, min.	0.14 mm <sup>2</sup>		
Connection cross-section, stranded, max.	6 mm <sup>2</sup>		
Connection cross-section, stranded, min.	0.14 mm <sup>2</sup>		
Twin wire-end ferrules, max.	1.5 mm <sup>2</sup>		
Twin wire-end ferrules, min.	0.5 mm <sup>2</sup>		
Wire connection cross-section, solid core, max.	4 mm <sup>2</sup>		
Wire connection cross-section, solid core, min.	0.14 mm <sup>2</sup>		
Connection cross-section, finely stranded, min.	0.14 mm <sup>2</sup>		
Tube length for wire-end ferrule with plastic collar DIN 46228/4	Tube length	min.	6 mm
		max.	12 mm
	Cross-section for conductor connection	min.	0.5 mm <sup>2</sup>
		max.	1 mm <sup>2</sup>

## AFS 4 2C BK

**Weidmüller Interface GmbH & Co. KG**

Klingenbergstraße 26  
D-32758 Detmold  
Germany

www.weidmueller.com

## Technical data

	Tube length	min.	8 mm
		max.	12 mm
	Cross-section for conductor connection	min.	1.5 mm <sup>2</sup>
		max.	2.5 mm <sup>2</sup>
Tube length for twin wire-end ferrule	Tube length	min.	10 mm
		max.	12 mm
	Cross-section for conductor connection	nominal	4 mm <sup>2</sup>
		Tube length	min.
Tube length for wire-end ferrule without plastic collar DIN 46228/1	Tube length	min.	6 mm
		max.	10 mm
	Cross-section for conductor connection	min.	0.5 mm <sup>2</sup>
		max.	1 mm <sup>2</sup>
	Tube length	min.	7 mm
		max.	12 mm
	Cross-section for conductor connection	min.	1.5 mm <sup>2</sup>
		max.	2.5 mm <sup>2</sup>
	Tube length	min.	9 mm
		max.	15 mm
	Cross-section for conductor connection	min.	4 mm <sup>2</sup>
		max.	6 mm <sup>2</sup>

### Fuse terminals

Cartridge fuse	G-Si. 5 x 20	Fuse holder (cartridge holder)	Pivoting
Type of voltage for indicator	AC/DC	Operating voltage, max.	250 V
Power loss for short-circuit protection only for a composite arrangement	2,5 W bei 6,3 A @ 32 °C	Power loss for short-circuit protection only for an individual arrangement	4,0 W bei 6,3 A @ 41 °C
Leakage current, max.	0.5 mA	Power loss for overload and short-circuit protection for an individual arrangement	1,6 W bei 6,3 A @ 31 °C
Power loss for overload and short-circuit protection for a composite arrangement	1.6 W at 6.3 A @ 34°C		

### General

Wire connection cross section AWG, max.	AWG 12	Installation advice	Rail
Wire connection cross section AWG, min.	AWG 26	Standards	DIN EN 60947-7-3
Mounting rail	TS 35		

### Rating data

Rated cross-section	4 mm <sup>2</sup>	Rated voltage	400 V
Rated voltage to adjoining terminal	500 V	Rated DC voltage	400 V
Nominal current	6.3 A	Current at maximum wires	6.3 A
Standards	DIN EN 60947-7-3	Volume resistance according to IEC 60947-7-x	1 mΩ
Rated impulse withstand voltage	4 kV	Power loss in accordance with IEC 60947-7-x	1.02 W
Surge voltage category	III	Pollution severity	3

### UL rating data

Conductor size Factory wiring max. (cURus)	10 AWG	Voltage size B (cURus)	300 V
Voltage size D (cURus)	300 V	Certificate No. (cURus)	E60693

**AFS 4 2C BK****Weidmüller Interface GmbH & Co. KG**

Klingenbergstraße 26

D-32758 Detmold

Germany

[www.weidmueller.com](http://www.weidmueller.com)**Technical data**

Conductor size Field wiring min. (cURus) 26 AWG	Conductor size Factory wiring min. (cURus) 26 AWG
Current size B (cURus) 10 A	Voltage size C (cURus) 150 V
Current size C (cURus) 10 A	Current size D (cURus) 10 A
Conductor size Field wiring max. (cURus) 10 AWG	

**Important note**

Product information      The voltage depends on the selected fuse element or the selected indicator light

**Classifications**

ETIM 8.0	EC000899	ETIM 9.0	EC000899
ETIM 10.0	EC000899	ECLASS 14.0	27-25-01-13
ECLASS 15.0	27-25-01-13		

**Drawings**

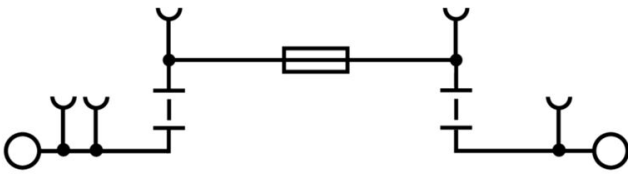

## AFS 4 2C BK

Weidmüller Interface GmbH &amp; Co. KG

Klingenbergstraße 26

D-32758 Detmold

Germany

www.weidmueller.com

## Accessories

## End plates and partition plates



Partition plates and end plates are essential accessories for terminal blocks. Partition plates provide optical and electrical separation of different potentials and functional groups, increasing safety and ensuring a clear structure inside the control cabinet. End plates close the terminal block row on the sides, protect against contact with live parts, and ensure a clean, stable finish. Both components are precisely matched to the respective Weidmüller terminal block series, contributing to safe, compliant, and professional wiring.

## General ordering data

Type	AEP 3C 4	Version
Order No.	<a href="#">2051720000</a>	A-series, End plate
GTIN (EAN)	4050118411829	
Qty.	20 ST	
Type	AEP 3C 4 BL	Version
Order No.	<a href="#">2051880000</a>	A-series, End plate
GTIN (EAN)	4050118411836	
Qty.	20 ST	
Type	AEP 3C 4 OR	Version
Order No.	<a href="#">2051890000</a>	A-series, End plate
GTIN (EAN)	4050118411799	
Qty.	20 ST	

## Blank



The Dekafix (DEK) marker is the universal marker for all conductor and plug-in connectors as well as for electronic sub-assemblies. The system is ideal for short number sequences and covers a wide range of ready-printed markers.

Strips for fast installation in only one work step. The printing is easy to read, rich in contrast and available in various widths.

- Large range of ready-to-use markers
  - Strips for fast installation
  - Terminal markers, suitable for all Weidmüller cable connectors
  - Available as blank MultiCard or with standard printing
- For custom printing: Please send us a file of our labeling software M-Print PRO or M-Print PRO Online (without installation) for your labeling specifications.

## General ordering data

Type	DEK 5/6 MC NE BL	Version
Order No.	<a href="#">1238290000</a>	Dekafix, Terminal marker, 5 x 6 mm, Pitch in mm (P): 6.00
GTIN (EAN)	4050118267327	Weidmueller, blue
Qty.	1000 ST	
Type	DEK 5/6 MC NE BR	Version
Order No.	<a href="#">1454900000</a>	Dekafix, Terminal marker, 5 x 6 mm, Pitch in mm (P): 6.00
GTIN (EAN)	4050118323313	Weidmueller, brown
Qty.	1000 ST	

## AFS 4 2C BK

Weidmüller Interface GmbH &amp; Co. KG

Klingenbergstraße 26

D-32758 Detmold

Germany

www.weidmueller.com

## Accessories

Type	DEK 5/6 MC NE GE	Version
Order No.	<a href="#">1238280000</a>	Dekafix, Terminal marker, 5 x 6 mm, Pitch in mm (P): 6.00
GTIN (EAN)	4050118038750	Weidmueller, yellow
Qty.	1000 ST	
Type	DEK 5/6 MC NE GN	Version
Order No.	<a href="#">1238310000</a>	Dekafix, Terminal marker, 5 x 6 mm, Pitch in mm (P): 6.00
GTIN (EAN)	4050118271812	Weidmueller, green
Qty.	1000 ST	
Type	DEK 5/6 MC NE GR	Version
Order No.	<a href="#">1238330000</a>	Dekafix, Terminal marker, 5 x 6 mm, Pitch in mm (P): 6.00
GTIN (EAN)	4050118323306	Weidmueller, grey
Qty.	1000 ST	
Type	DEK 5/6 MC NE OR	Version
Order No.	<a href="#">1912090000</a>	Dekafix, Terminal marker, 5 x 6 mm, Pitch in mm (P): 6.00
GTIN (EAN)	4032248540525	Weidmueller, orange
Qty.	1000 ST	
Type	DEK 5/6 MC NE WS	Version
Order No.	<a href="#">1609820000</a>	Dekafix, Terminal marker, 5 x 6 mm, Pitch in mm (P): 6.00
GTIN (EAN)	4008190203436	Weidmueller, white
Qty.	1000 ST	

## Custom printing



The Dekafix (DEK) marker is the universal marker for all conductor and plug-in connectors as well as for electronic sub-assemblies. The system is ideal for short number sequences and covers a wide range of ready-printed markers.

Strips for fast installation in only one work step. The printing is easy to read, rich in contrast and available in various widths.

- Large range of ready-to-use markers
  - Strips for fast installation
  - Terminal markers, suitable for all Weidmüller cable connectors
  - Available as blank MultiCard or with standard printing
- For custom printing: Please send us a file of our labeling software M-Print PRO or M-Print PRO Online (without installation) for your labeling specifications.

## General ordering data

Type	DEK 5/6 MC SDR	Version
Order No.	<a href="#">1609830000</a>	Dekafix, Terminal marker, 5 x 6 mm, Pitch in mm (P): 6.00
GTIN (EAN)	4008190456603	Weidmueller, To customer specification
Qty.	200 ST	

**AFS 4 2C BK**

**Weidmüller Interface GmbH & Co. KG**  
 Klingenbergstraße 26  
 D-32758 Detmold  
 Germany

www.weidmueller.com

**Accessories**

**Plus**



The Dekafix (DEK) marker is the universal marker for all conductor and plug-in connectors as well as for electronic sub-assemblies. The system is ideal for short number sequences and covers a wide range of ready-printed markers.

Strips for fast installation in only one work step. The printing is easy to read, rich in contrast and available in various widths.

- Large range of ready-to-use markers
  - Strips for fast installation
  - Terminal markers, suitable for all Weidmüller cable connectors
  - Available as blank MultiCard or with standard printing
- For custom printing: Please send us a file of our labeling software M-Print PRO or M-Print PRO Online (without installation) for your labeling specifications.

**General ordering data**

Type	DEK 5/6 PLUS MC NE WS	Version
Order No.	<a href="#">1011320000</a>	Dekafix, Terminal marker, 5 x 6 mm, Pitch in mm (P): 6.00
GTIN (EAN)	4032248717644	Weidmueller, white
Qty.	1000 ST	

**Custom printing**



The Dekafix (DEK) marker is the universal marker for all conductor and plug-in connectors as well as for electronic sub-assemblies. The system is ideal for short number sequences and covers a wide range of ready-printed markers.

Strips for fast installation in only one work step. The printing is easy to read, rich in contrast and available in various widths.

- Large range of ready-to-use markers
  - Strips for fast installation
  - Terminal markers, suitable for all Weidmüller cable connectors
  - Available as blank MultiCard or with standard printing
- For custom printing: Please send us a file of our labeling software M-Print PRO or M-Print PRO Online (without installation) for your labeling specifications.

**General ordering data**

Type	DEK 5/6 PLUS MC SDR	Version
Order No.	<a href="#">1038650000</a>	Dekafix, Terminal marker, 5 x 6 mm, Pitch in mm (P): 6.00
GTIN (EAN)	4032248767908	Weidmueller, To customer specification
Qty.	200 ST	

Type	WS 10/6 M PLUS MC SDR	Version
Order No.	<a href="#">2007780000</a>	WS, Terminal marker, 10 x 6 mm, Pitch in mm (P): 6.00 Weidmueller,
GTIN (EAN)	4050118393187	Allen-Bradley, To customer specification
Qty.	120 ST	

## AFS 4 2C BK

Weidmüller Interface GmbH &amp; Co. KG

Klingenbergstraße 26

D-32758 Detmold

Germany

## Accessories

www.weidmueller.com

## Blank

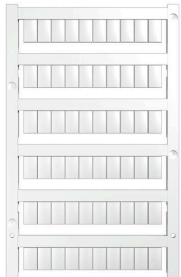

WS markers are the perfect match for the W-series connectors. Thanks to their system compatibility, the WS tags can also be used with the I-series and the Z-series. The large marking surfaces do not only permit long character strings but also multi-line text. WS markers are ideal for labels with long, customised character strings. Thanks to the proven MultiCard format, printing with PrintJet CONNECT oder/or Plotter is possible.

- Can be fitted in strips or individually
- Markers in proven MultiCard format

For custom printing: Please send us a file of our labeling software M-Print PRO or M-Print PRO Online (without installation) for your labeling specifications.

## General ordering data

Type	WS 10/6 M PLUS MC NE WS	Version
Order No.	<a href="#">2003780000</a>	WS, Terminal marker, 10 x 6 mm, Pitch in mm (P): 6.00 Weidmueller,
GTIN (EAN)	4050118424461	Allen-Bradley, white
Qty.	600 ST	
Type	WS 10/6 MC M NE BL	Version
Order No.	<a href="#">1069080000</a>	WS, Terminal marker, 10 x 6 mm, Pitch in mm (P): 6.00 Weidmueller,
GTIN (EAN)	4032248824618	Allen-Bradley, blue
Qty.	600 ST	
Type	WS 10/6 MC M NE GE	Version
Order No.	<a href="#">1917430000</a>	WS, Terminal marker, 10 x 6 mm, Pitch in mm (P): 6.00 Weidmueller,
GTIN (EAN)	4032248551637	Allen-Bradley, yellow
Qty.	600 ST	
Type	WS 10/6 MC M NE GN	Version
Order No.	<a href="#">1917420000</a>	WS, Terminal marker, 10 x 6 mm, Pitch in mm (P): 6.00 Weidmueller,
GTIN (EAN)	4032248551620	Allen-Bradley, green
Qty.	600 ST	
Type	WS 10/6 MC M NE RT	Version
Order No.	<a href="#">1917440000</a>	WS, Terminal marker, 10 x 6 mm, Pitch in mm (P): 6.00 Weidmueller,
GTIN (EAN)	4032248551644	Allen-Bradley, red
Qty.	600 ST	
Type	WS 10/6 M MC NE WS	Version
Order No.	<a href="#">1818400000</a>	WS, Terminal marker, 10 x 6 mm, Pitch in mm (P): 6.00 Weidmueller,
GTIN (EAN)	4032248310876	Allen-Bradley, white
Qty.	600 ST	

## AFS 4 2C BK

Weidmüller Interface GmbH &amp; Co. KG

Klingenbergstraße 26

D-32758 Detmold

Germany

## Accessories

www.weidmueller.com

## Custom printing

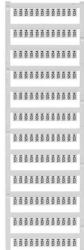

WS markers are the perfect match for the W-series connectors. Thanks to their system compatibility, the WS tags can also be used with the I-series and the Z-series. The large marking surfaces do not only permit long character strings but also multi-line text. WS markers are ideal for labels with long, customised character strings. Thanks to the proven MultiCard format, printing with PrintJet CONNECT oder/or Plotter is possible.

- Can be fitted in strips or individually
- Markers in proven MultiCard format

For custom printing: Please send us a file of our labeling software M-Print PRO or M-Print PRO Online (without installation) for your labeling specifications.

## General ordering data

Type	WS 10/6 MC M SDR	Version
Order No.	<a href="#">1818410000</a>	WS, Terminal marker, 10 x 6 mm, Pitch in mm (P): 6.00 Weidmueller,
GTIN (EAN)	4032248310883	Allen-Bradley, To customer specification
Qty.	120 ST	

## Blank



WS markers are the perfect match for the W-series connectors. Thanks to their system compatibility, the WS tags can also be used with the I-series and the Z-series. The large marking surfaces do not only permit long character strings but also multi-line text. WS markers are ideal for labels with long, customised character strings. Thanks to the proven MultiCard format, printing with PrintJet CONNECT oder/or Plotter is possible.

- Can be fitted in strips or individually
- Markers in proven MultiCard format

For custom printing: Please send us a file of our labeling software M-Print PRO or M-Print PRO Online (without installation) for your labeling specifications.

## General ordering data

Type	WS 10/6 MC NE WS	Version
Order No.	<a href="#">1828450000</a>	WS, Terminal marker, 10 x 6 mm, Pitch in mm (P): 6.00 Weidmueller,
GTIN (EAN)	4032248350513	Allen-Bradley, white
Qty.	600 ST	

## AFS 4 2C BK

Weidmüller Interface GmbH &amp; Co. KG

Klingenbergstraße 26

D-32758 Detmold

Germany

## Accessories

www.weidmueller.com

## Custom printing



WS markers are the perfect match for the W-series connectors. Thanks to their system compatibility, the WS tags can also be used with the I-series and the Z-series. The large marking surfaces do not only permit long character strings but also multi-line text. WS markers are ideal for labels with long, customised character strings. Thanks to the proven MultiCard format, printing with PrintJet CONNECT oder/or Plotter is possible.

- Can be fitted in strips or individually
- Markers in proven MultiCard format

For custom printing: Please send us a file of our labeling software M-Print PRO or M-Print PRO Online (without installation) for your labeling specifications.

## General ordering data

Type	WS 10/6 MC SDR	Version
Order No.	<a href="#">1828460000</a>	WS, Terminal marker, 10 x 6 mm, Pitch in mm (P): 6.00 Weidmueller,
GTIN (EAN)	4032248367399	Allen-Bradley, To customer specification
Qty.	120 ST	

## Blank



WS markers are the perfect match for the W-series connectors. Thanks to their system compatibility, the WS tags can also be used with the I-series and the Z-series. The large marking surfaces do not only permit long character strings but also multi-line text. WS markers are ideal for labels with long, customised character strings. Thanks to the proven MultiCard format, printing with PrintJet CONNECT oder/or Plotter is possible.

- Can be fitted in strips or individually
- Markers in proven MultiCard format

For custom printing: Please send us a file of our labeling software M-Print PRO or M-Print PRO Online (without installation) for your labeling specifications.

## General ordering data

Type	WS 10/6 PLUS MC NE WS	Version
Order No.	<a href="#">1046390000</a>	WS, Terminal marker, 10 x 6 mm, Pitch in mm (P): 6.00 Weidmueller,
GTIN (EAN)	4032248782109	Allen-Bradley, white
Qty.	600 ST	

## AFS 4 2C BK

**Weidmüller Interface GmbH & Co. KG**  
 Klingenbergstraße 26  
 D-32758 Detmold  
 Germany

## Accessories

www.weidmueller.com

### Custom printing



WS markers are the perfect match for the W-series connectors. Thanks to their system compatibility, the WS tags can also be used with the I-series and the Z-series. The large marking surfaces do not only permit long character strings but also multi-line text. WS markers are ideal for labels with long, customised character strings. Thanks to the proven MultiCard format, printing with PrintJet CONNECT oder/or Plotter is possible.

- Can be fitted in strips or individually
- Markers in proven MultiCard format

For custom printing: Please send us a file of our labeling software M-Print PRO or M-Print PRO Online (without installation) for your labeling specifications.

### General ordering data

Type	WS 10/6 PLUS MC SDR	Version
Order No.	<a href="#">1046330000</a>	WS, Terminal marker, 10 x 6 mm, Pitch in mm (P): 6.00 Weidmueller,
GTIN (EAN)	4032248782031	Allen-Bradley, To customer specification
Qty.	120 ST	

### Blank

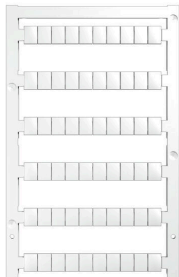

WS markers are the perfect match for the W-series connectors. Thanks to their system compatibility, the WS tags can also be used with the I-series and the Z-series. The large marking surfaces do not only permit long character strings but also multi-line text. WS markers are ideal for labels with long, customised character strings. Thanks to the proven MultiCard format, printing with PrintJet CONNECT oder/or Plotter is possible.

- Can be fitted in strips or individually
- Markers in proven MultiCard format

For custom printing: Please send us a file of our labeling software M-Print PRO or M-Print PRO Online (without installation) for your labeling specifications.

### General ordering data

Type	WS 8/6 PLUS MC NE WS	Version
Order No.	<a href="#">1951880000</a>	WS, Terminal marker, 8 x 6 mm, Pitch in mm (P): 6.00 Weidmueller,
GTIN (EAN)	4032248632114	white
Qty.	600 ST	

## AFS 4 2C BK

Weidmüller Interface GmbH &amp; Co. KG

Klingenbergstraße 26

D-32758 Detmold

Germany

www.weidmueller.com

## Accessories

## Custom printing



WS markers are the perfect match for the W-series connectors. Thanks to their system compatibility, the WS tags can also be used with the I-series and the Z-series. The large marking surfaces do not only permit long character strings but also multi-line text. WS markers are ideal for labels with long, customised character strings. Thanks to the proven MultiCard format, printing with PrintJet CONNECT oder/or Plotter is possible.

- Can be fitted in strips or individually
- Markers in proven MultiCard format

For custom printing: Please send us a file of our labeling software M-Print PRO or M-Print PRO Online (without installation) for your labeling specifications.

## General ordering data

Type	WS 8/6 PLUS MC SDR	Version	
Order No.	<a href="#">1038820000</a>	WS, Terminal marker, 8 x 6 mm, Pitch in mm (P): 6.00 Weidmueller,	
GTIN (EAN)	4032248768073	To customer specification	
Qty.	120 ST		

## DEK 5/6



## WS/ DEK

MultiMark terminal markers use an innovative composite material made from two components. The hard base contour of the marker snaps securely into the connector. The elastic surface finish makes the marker easy to mount. This specially punched material enables the strips to be stretched to accommodate the slight variations in spacing that tend to add up, especially with long terminal blocks. Another advantage: the excellent printability of the surface material guarantees durable and wear-resistant labelling. A print resolution of 300 dpi also produces a very legible script.

Your benefits with MultiMark

- Firm hold and durable printing
- Continuous strips save installation time
- Easy mounting thanks to an innovative composite material
- Large label field for optimal legibility
- High flexibility thanks to manufacturer independence

## General ordering data

Type	DEK 5/6 MM WS	Version	
Order No.	<a href="#">2007120000</a>	Dekafix, Terminal marker, 5 x 6 mm, Weidmueller, white	
GTIN (EAN)	4050118392104		
Qty.	600 ST		

## AFS 4 2C BK

Weidmüller Interface GmbH &amp; Co. KG

Klingenbergstraße 26

D-32758 Detmold

Germany

## Accessories

www.weidmueller.com

## WS 8/6



## WS/ DEK

MultiMark terminal markers use an innovative composite material made from two components. The hard base contour of the marker snaps securely into the connector. The elastic surface finish makes the marker easy to mount. This specially punched material enables the strips to be stretched to accommodate the slight variations in spacing that tend to add up, especially with long terminal blocks. Another advantage: the excellent printability of the surface material guarantees durable and wear-resistant labelling. A print resolution of 300 dpi also produces a very legible script.

Your benefits with MultiMark

- Firm hold and durable printing
- Continuous strips save installation time
- Easy mounting thanks to an innovative composite material
- Large label field for optimal legibility
- High flexibility thanks to manufacturer independence

## General ordering data

Type	WS 8/6 MM WS	Version	
Order No.	<a href="#">2007160000</a>	WS, Terminal marker, 8 x 6 mm, Weidmueller, white	
GTIN (EAN)	4050118391879		
Qty.	600 ST		

## Coding elements



The pluggable connections for power electronics - optimised for modern drive technologies, e.g. motor starters, frequency converters and servo-controllers. OMNIMATE Power sets the new standard - with increased safety and innovative solutions such as the pluggable shield, integrated signal contacts and one-handed operation.

The three product lines offer you further advantages:

- Application-oriented scalability: from the compact 4 mm<sup>2</sup> connector for 29 A (IEC) or 20 A (UL) up to the sturdy 16 mm<sup>2</sup> connector for 76 A (IEC) or 54 A (UL)
- Unlimited usage up to 1,000 V (IEC) or 600 V (UL)
- A variety of application optimised mounting options

Our service:

Design your individual connectors simply by using the product configurator.

## General ordering data

Type	VDS180 SV7.62	Version	
Order No.	<a href="#">1853940000</a>	PCB plug-in connector, Accessories, black, Number of poles: 1	
GTIN (EAN)	4032248389513		
Qty.	50 ST		

## AFS 4 2C BK

Weidmüller Interface GmbH &amp; Co. KG

Klingenbergstraße 26

D-32758 Detmold

Germany

www.weidmueller.com

## Accessories

## End plates and partition plates



Partition plates and end plates are essential accessories for terminal blocks. Partition plates provide optical and electrical separation of different potentials and functional groups, increasing safety and ensuring a clear structure inside the control cabinet. End plates close the terminal block row on the sides, protect against contact with live parts, and ensure a clean, stable finish. Both components are precisely matched to the respective Weidmüller terminal block series, contributing to safe, compliant, and professional wiring.

## General ordering data

Type	AEP 3C 4 BK	Version	
Order No.	<a href="#">2486640000</a>	Version	A-series, End plate
GTIN (EAN)	4050118497458		
Qty.	20 ST		

## End bracket

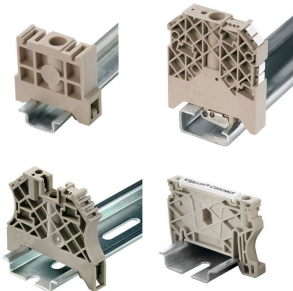

Weidmüller's range of products includes end brackets that guarantee a permanent, reliable mounting on the terminal rail and prevent sliding. Versions with and without screws are available. The end brackets include marking options, also for group markers, and also a test plug holder.

## General ordering data

Type	AEB 35 SC/1	Version	
Order No.	<a href="#">1991920000</a>	Version	A-series, End bracket
GTIN (EAN)	4050118376722		
Qty.	50 ST		
Type	AEB 35 SC/1 BK	Version	
Order No.	<a href="#">2475310000</a>	Version	A-series, End bracket
GTIN (EAN)	4050118487114		
Qty.	50 ST		

## Cross-connections

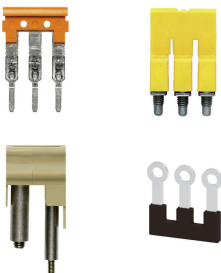

The distribution or multiplication of a potential to adjoining terminal blocks is realized via a cross-connection. Additional wiring effort can be easily avoided. Even if the poles are broken out, contact reliability in the terminal blocks is still ensured. Our portfolio offers pluggable and screwable cross-connection systems for modular terminal blocks.

## AFS 4 2C BK

Weidmüller Interface GmbH &amp; Co. KG

Klingenbergstraße 26

D-32758 Detmold

Germany

www.weidmueller.com

## Accessories

## General ordering data

Type	ZQV 4N/10	Version
Order No.	<a href="#">1528090000</a>	Cross-connector (terminal), Plugged, orange, 32 A, Number of poles:
GTIN (EAN)	4050118332896	10, Pitch in mm (P): 6.10, Insulated: Yes, Width: 58.7 mm
Qty.	20 ST	
Type	ZQV 4N/10 BL	Version
Order No.	<a href="#">1528230000</a>	Cross-connector (terminal), Plugged, blue, 32 A, Number of poles: 10,
GTIN (EAN)	4050118333138	Pitch in mm (P): 6.10, Insulated: Yes, Width: 58.7 mm
Qty.	20 ST	
Type	ZQV 4N/10 RD	Version
Order No.	<a href="#">2460740000</a>	Cross-connector (terminal), Plugged, red, 32 A, Number of poles: 10,
GTIN (EAN)	4050118476163	Pitch in mm (P): 6.10, Insulated: Yes, Width: 58.7 mm
Qty.	20 ST	
Type	ZQV 4N/2	Version
Order No.	<a href="#">1527930000</a>	Cross-connector (terminal), Plugged, orange, 32 A, Number of poles:
GTIN (EAN)	4050118332766	2, Pitch in mm (P): 6.10, Insulated: Yes, Width: 9.9 mm
Qty.	60 ST	
Type	ZQV 4N/2 BL	Version
Order No.	<a href="#">1528040000</a>	Cross-connector (terminal), Plugged, blue, 32 A, Number of poles: 2,
GTIN (EAN)	4050118332773	Pitch in mm (P): 6.10, Insulated: Yes, Width: 9.9 mm
Qty.	60 ST	
Type	ZQV 4N/2 RD	Version
Order No.	<a href="#">2460450000</a>	Cross-connector (terminal), Plugged, red, 32 A, Number of poles: 2,
GTIN (EAN)	4050118476149	Pitch in mm (P): 6.10, Insulated: Yes, Width: 9.9 mm
Qty.	60 ST	
Type	ZQV 4N/3	Version
Order No.	<a href="#">1527940000</a>	Cross-connector (terminal), Plugged, orange, 32 A, Number of poles:
GTIN (EAN)	4050118332865	3, Pitch in mm (P): 6.10, Insulated: Yes, Width: 16 mm
Qty.	60 ST	
Type	ZQV 4N/3 BL	Version
Order No.	<a href="#">1528080000</a>	Cross-connector (terminal), Plugged, blue, 32 A, Number of poles: 3,
GTIN (EAN)	4050118333008	Pitch in mm (P): 6.10, Insulated: Yes, Width: 16 mm
Qty.	60 ST	
Type	ZQV 4N/3 RD	Version
Order No.	<a href="#">2460810000</a>	Cross-connector (terminal), Plugged, red, 32 A, Number of poles: 3,
GTIN (EAN)	4050118476231	Pitch in mm (P): 6.10, Insulated: Yes, Width: 16 mm
Qty.	60 ST	
Type	ZQV 4N/30	Version
Order No.	<a href="#">2561580000</a>	Cross-connector (terminal), Plugged, orange, 32 A, Number of poles:
GTIN (EAN)	4050118570113	30, Pitch in mm (P): 6.10, Insulated: Yes, Width: 181.7 mm
Qty.	5 ST	
Type	ZQV 4N/30 BL	Version
Order No.	<a href="#">2561610000</a>	Cross-connector (terminal), Plugged, blue, 32 A, Number of poles: 30,
GTIN (EAN)	4050118569971	Pitch in mm (P): 6.10, Insulated: Yes, Width: 181.7 mm
Qty.	5 ST	
Type	ZQV 4N/30 RD	Version
Order No.	<a href="#">2561600000</a>	Cross-connector (terminal), Plugged, red, 32 A, Number of poles: 30,
GTIN (EAN)	4050118569964	Pitch in mm (P): 6.10, Insulated: Yes, Width: 181.7 mm
Qty.	5 ST	
Type	ZQV 4N/32	Version
Order No.	<a href="#">2561670000</a>	Cross-connector (terminal), Plugged, orange, 32 A, Number of poles:
GTIN (EAN)	4050118570175	32, Pitch in mm (P): 6.10, Insulated: Yes, Width: 193.9 mm
Qty.	5 ST	

## AFS 4 2C BK

**Weidmüller Interface GmbH & Co. KG**

Klingenbergstraße 26  
D-32758 Detmold  
Germany

www.weidmueller.com

## Accessories

Type	ZQV 4N/4	Version
Order No.	<a href="#">1527970000</a>	Cross-connector (terminal), Plugged, orange, 32 A, Number of poles:
GTIN (EAN)	4050118332889	4, Pitch in mm (P): 6.10, Insulated: Yes, Width: 22.1 mm
Qty.	60 ST	
Type	ZQV 4N/4 BL	Version
Order No.	<a href="#">1528120000</a>	Cross-connector (terminal), Plugged, blue, 32 A, Number of poles: 4,
GTIN (EAN)	4050118332872	Pitch in mm (P): 6.10, Insulated: Yes, Width: 22.1 mm
Qty.	60 ST	
Type	ZQV 4N/4 RD	Version
Order No.	<a href="#">2460800000</a>	Cross-connector (terminal), Plugged, red, 32 A, Number of poles: 4,
GTIN (EAN)	4050118476224	Pitch in mm (P): 6.10, Insulated: Yes, Width: 22.1 mm
Qty.	60 ST	
Type	ZQV 4N/5	Version
Order No.	<a href="#">1527980000</a>	Cross-connector (terminal), Plugged, orange, 32 A, Number of poles:
GTIN (EAN)	4050118332759	5, Pitch in mm (P): 6.10, Insulated: Yes, Width: 28.2 mm
Qty.	60 ST	
Type	ZQV 4N/5 BL	Version
Order No.	<a href="#">1528140000</a>	Cross-connector (terminal), Plugged, blue, 32 A, Number of poles: 5,
GTIN (EAN)	4050118333015	Pitch in mm (P): 6.10, Insulated: Yes, Width: 28.2 mm
Qty.	60 ST	
Type	ZQV 4N/5 RD	Version
Order No.	<a href="#">2460790000</a>	Cross-connector (terminal), Plugged, red, 32 A, Number of poles: 5,
GTIN (EAN)	4050118476217	Pitch in mm (P): 6.10, Insulated: Yes, Width: 28.2 mm
Qty.	60 ST	
Type	ZQV 4N/50	Version
Order No.	<a href="#">1528130000</a>	Cross-connector (terminal), Plugged, orange, 32 A, Number of poles:
GTIN (EAN)	4050118332902	50, Pitch in mm (P): 6.10, Insulated: Yes, Width: 303.7 mm
Qty.	5 ST	
Type	ZQV 4N/50 BL	Version
Order No.	<a href="#">1528240000</a>	Cross-connector (terminal), Plugged, blue, 32 A, Number of poles: 50,
GTIN (EAN)	4050118333121	Pitch in mm (P): 6.10, Insulated: Yes, Width: 303.7 mm
Qty.	5 ST	
Type	ZQV 4N/50 RD	Version
Order No.	<a href="#">2460730000</a>	Cross-connector (terminal), Plugged, red, 32 A, Number of poles: 50,
GTIN (EAN)	4050118476156	Pitch in mm (P): 6.10, Insulated: Yes, Width: 303.7 mm
Qty.	5 ST	
Type	ZQV 4N/6	Version
Order No.	<a href="#">1527990000</a>	Cross-connector (terminal), Plugged, orange, 32 A, Number of poles:
GTIN (EAN)	4050118332919	6, Pitch in mm (P): 6.10, Insulated: Yes, Width: 34.3 mm
Qty.	20 ST	
Type	ZQV 4N/6 BL	Version
Order No.	<a href="#">1528170000</a>	Cross-connector (terminal), Plugged, blue, 32 A, Number of poles: 6,
GTIN (EAN)	4050118332926	Pitch in mm (P): 6.10, Insulated: Yes, Width: 34.3 mm
Qty.	20 ST	
Type	ZQV 4N/6 RD	Version
Order No.	<a href="#">2460780000</a>	Cross-connector (terminal), Plugged, red, 32 A, Number of poles: 6,
GTIN (EAN)	4050118476200	Pitch in mm (P): 6.10, Insulated: Yes, Width: 34.3 mm
Qty.	20 ST	
Type	ZQV 4N/7	Version
Order No.	<a href="#">1528020000</a>	Cross-connector (terminal), Plugged, orange, 32 A, Number of poles:
GTIN (EAN)	4050118332780	7, Pitch in mm (P): 6.10, Insulated: Yes, Width: 40.4 mm
Qty.	20 ST	

## AFS 4 2C BK

**Weidmüller Interface GmbH & Co. KG**  
 Klingenbergstraße 26  
 D-32758 Detmold  
 Germany

www.weidmueller.com

## Accessories

Type	ZQV 4N/7 BL	Version
Order No.	<a href="#">1528180000</a>	Cross-connector (terminal), Plugged, blue, 32 A, Number of poles: 7,
GTIN (EAN)	4050118333114	Pitch in mm (P): 6.10, Insulated: Yes, Width: 40.4 mm
Qty.	20 ST	
Type	ZQV 4N/7 RD	Version
Order No.	<a href="#">2460770000</a>	Cross-connector (terminal), Plugged, red, 32 A, Number of poles: 7,
GTIN (EAN)	4050118476194	Pitch in mm (P): 6.10, Insulated: Yes, Width: 40.4 mm
Qty.	20 ST	
Type	ZQV 4N/8	Version
Order No.	<a href="#">1528030000</a>	Cross-connector (terminal), Plugged, orange, 32 A, Number of poles: 8,
GTIN (EAN)	4050118332841	Pitch in mm (P): 6.10, Insulated: Yes, Width: 46.5 mm
Qty.	20 ST	
Type	ZQV 4N/8 BL	Version
Order No.	<a href="#">1528190000</a>	Cross-connector (terminal), Plugged, blue, 32 A, Number of poles: 8,
GTIN (EAN)	4050118332858	Pitch in mm (P): 6.10, Insulated: Yes, Width: 46.5 mm
Qty.	20 ST	
Type	ZQV 4N/8 RD	Version
Order No.	<a href="#">2460760000</a>	Cross-connector (terminal), Plugged, red, 32 A, Number of poles: 8,
GTIN (EAN)	4050118476187	Pitch in mm (P): 6.10, Insulated: Yes, Width: 46.5 mm
Qty.	20 ST	
Type	ZQV 4N/9	Version
Order No.	<a href="#">1528070000</a>	Cross-connector (terminal), Plugged, orange, 32 A, Number of poles: 9,
GTIN (EAN)	4050118332797	Pitch in mm (P): 6.10, Insulated: Yes, Width: 52.6 mm
Qty.	20 ST	
Type	ZQV 4N/9 BL	Version
Order No.	<a href="#">1528220000</a>	Cross-connector (terminal), Plugged, blue, 32 A, Number of poles: 9,
GTIN (EAN)	4050118333107	Pitch in mm (P): 6.10, Insulated: Yes, Width: 52.6 mm
Qty.	20 ST	
Type	ZQV 4N/9 RD	Version
Order No.	<a href="#">2460750000</a>	Cross-connector (terminal), Plugged, red, 32 A, Number of poles: 9,
GTIN (EAN)	4050118476170	Pitch in mm (P): 6.10, Insulated: Yes, Width: 52.6 mm
Qty.	20 ST	

## Marker holder



The marker holder offer the possibility of additional mounting of standard markers with a pitch of 5 or 5.1 mm. The angled holders can be optionally snapped together and could be mounted in all standard marking channels of the Klippon® Connect modular terminal blocks. Fitting marker types could be found under the respective accessories of the designation marking holder.

## General ordering data

Type	BZT 1 WS 10/5	Version
Order No.	<a href="#">1805490000</a>	Accessories, Marker holder
GTIN (EAN)	4032248270231	
Qty.	100 ST	

## AFS 4 2C BK

Weidmüller Interface GmbH &amp; Co. KG

Klingenbergstraße 26

D-32758 Detmold

Germany

www.weidmueller.com

## Accessories

Type	BZT 1 ZA WS 10/5	Version	
Order No.	<a href="#">1805520000</a>	Accessories, Marker holder	
GTIN (EAN)	4032248270248		
Qty.	100 ST		

## End plates and partition plates



Partition plates and end plates are essential accessories for terminal blocks. Partition plates provide optical and electrical separation of different potentials and functional groups, increasing safety and ensuring a clear structure inside the control cabinet. End plates close the terminal block row on the sides, protect against contact with live parts, and ensure a clean, stable finish. Both components are precisely matched to the respective Weidmüller terminal block series, contributing to safe, compliant, and professional wiring.

## General ordering data

Type	APP 2	Version	
Order No.	<a href="#">2489090000</a>	A-series, Partition plate	
GTIN (EAN)	4050118499308		
Qty.	50 ST		

## Warning cover

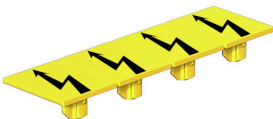

Warning covers with a flash symbol provide more safety for man and machine. They are used where external voltage must be indicated within the application.

## General ordering data

Type	AAM 4 YE FLASH	Version	
Order No.	<a href="#">2635560000</a>	A-series, Terminal marker, 10 x 6.1 mm, Pitch in mm (P): 6.00 yellow	
GTIN (EAN)	4050118674507		
Qty.	40 ST		

## AFS 4 2C BK

**Weidmüller Interface GmbH & Co. KG**  
 Klingenbergstraße 26  
 D-32758 Detmold  
 Germany

www.weidmueller.com

## Accessories

### End bracket



Weidmüller's range of products includes end brackets that guarantee a permanent, reliable mounting on the terminal rail and prevent sliding. Versions with and without screws are available. The end brackets include marking options, also for group markers, and also a test plug holder.

### General ordering data

Type	AEB 35 SCL/1 V0	Version
Order No.	<a href="#">2661280000</a>	A-series, End bracket
GTIN (EAN)	4050118702163	
Qty.	20 ST	
Type	AEB 35 SCL/1 V0 BK	Version
Order No.	<a href="#">2661300000</a>	A-series, End bracket
GTIN (EAN)	4050118702187	
Qty.	20 ST	
Type	AEB 35 SCL/1 V0 GY	Version
Order No.	<a href="#">2661290000</a>	A-series, End bracket
GTIN (EAN)	4050118702170	
Qty.	20 ST	
Type	ZST 1	Version
Order No.	<a href="#">1269070000</a>	Accessories, Accessories holder
GTIN (EAN)	4050118094091	
Qty.	25 ST	

### Slotted screwdriver



VDE insulated screwdriver sets, for working on live parts up to 1000 V AC and 1500 V DC, DIN EN 60900. IEC 900. Each piece is "GS" safety tested. Blade made from fully hardened, high-alloy chromium-vanadium-molybdenum steel, gun-metal finish.

### General ordering data

Type	SDIS SLIM 0.6X3.5X100	Version
Order No.	<a href="#">2749610000</a>	Mounting tool, Blade width (B): 3.5 mm, Blade length: 100 mm, Blade thickness (A): 0.6 mm
GTIN (EAN)	4050118896350	
Qty.	1 ST	

## AFS 4 2C BK

**Weidmüller Interface GmbH & Co. KG**  
 Klingenbergstraße 26  
 D-32758 Detmold  
 Germany

www.weidmueller.com

## Accessories

### Cross-connections

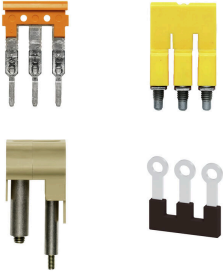

The distribution or multiplication of a potential to adjoining terminal blocks is realized via a cross-connection. Additional wiring effort can be easily avoided. Even if the poles are broken out, contact reliability in the terminal blocks is still ensured. Our portfolio offers pluggable and screwable cross-connection systems for modular terminal blocks.

### General ordering data

Type	VH 20/5/3.4	Version	
Order No.	<a href="#">0446100000</a>	Dummy fuse	
GTIN (EAN)	4008190519742		
Qty.	10 ST		

### Testadapter and testsockets



Test adapters and test plugs are used for the electrical connection between terminal blocks and the test equipment. In this way, an electrical contact can be established in the wired state and measurements can be done easily.

### General ordering data

Type	FZS 2/4 RT/80 SAKT4	Version	
Order No.	<a href="#">1276300000</a>	Plug (terminal), Plug-in connection, 2 mm <sup>2</sup> , Number of connections: 2,	
GTIN (EAN)	4008190026080	Number of poles: 1, Width: 9 mm	
Qty.	20 ST		