

## SAIE-M12S-5S-H5.5TL

**Weidmüller Interface GmbH & Co. KG**  
 Klingenbergstraße 26  
 D-32758 Detmold  
 Germany

[www.weidmueller.com](http://www.weidmueller.com)

### Similar to illustration

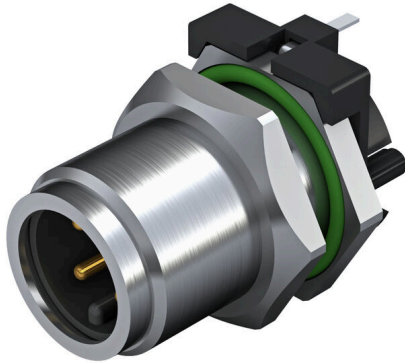

Weidmüller is one of the industry's leading international providers of connectors. An important mainstay in this product family are the circular connectors, which Weidmüller groups under the product name SAI. In the development of SAI products, Weidmüller engineers have always concentrated on achieving rational, cost-effective installation concepts, and – in cooperation with major users – have supplied the markets with well-conceived products which set standards in terms of functionality and quality across the globe. The best examples are the new power distributors with S and T coded M12. These modules are characterised by particularly high currents and voltages. This enables them to also be used, for example, with three-phase motors.

### General ordering data

Version	Built-in plugs, M12, Mounting thread: M 12, Number of poles: 5, Strand / cable length:
Order No.	<a href="#">2423390000</a>
Type	SAIE-M12S-5S-H5.5TL
GTIN (EAN)	4050118431247
Qty.	10 items

## SAIE-M12S-5S-H5.5TL

Weidmüller Interface GmbH &amp; Co. KG

Klingenbergstraße 26

D-32758 Detmold

Germany

www.weidmueller.com

## Technical data

## Approvals

ROHS Conform

## Dimensions and weights

Net weight 8.2 g

## Environmental Product Compliance

RoHS Compliance Status	Compliant with exemption
RoHS Exemption (if applicable/known)	6c
REACH SVHC	Lead 7439-92-1
SCIP	Oea6d931-f9e9-40a6-89d9-8d67103189d3

## Technical data of PCB plug-in connector

Number of poles	5
Coding	A-coded
Type of mounting	Rear panel mounting
Housings	M12 pin
Installation height	5.5 mm
Housing surface	nickel-plated
Shield connection	Yes
Mounting thread	M12
Nominal voltage	60 V
Rated voltage	250 V (4-pole) / 60 V (5-pole)
Nominal current	4 A
Rated current	4 A
Temperature range	-30...80 °C
Protection degree	IP67
Contact surface	Au (Gold)
Housing main material	CuZn, nickel-plated
Connection thread	M12
Tightening torque	M12: 0.8 Nm
Mounting thread	M 12
Mounting torque range	1.2 Nm
Mounting torque	max. 1.2 Nm
Insulation resistance	100 MΩ
Pollution severity	3 (2 within the sealed area)
Plugging cycles	≥ 100
Contact material	Cu-alloy
Lock nut material	Nickel-plated CuZn
Material of the flange-mounted housing	Nickel-plated CuZn

## General Info

Number of poles	5	Housing main material	CuZn, nickel-plated
Connection thread	M12	Contact material	Cu-alloy
Contact surface	Au (Gold)	Type of mounting	Rear panel mounting
Protection degree	IP67	Plugging cycles	≥ 100

## Material data

Contact material	Cu-alloy	Contact surface	Au (Gold)
------------------	----------	-----------------	-----------

## SAIE-M12S-5S-H5.5TL

**Weidmüller Interface GmbH & Co. KG**  
Klingenbergstraße 26  
D-32758 Detmold  
Germany

[www.weidmueller.com](http://www.weidmueller.com)

## Technical data

### System parameters

Number of poles	5	Pin series quantity	1
Insulation resistance	100 MΩ	Protection degree	IP67
Plugging cycles	≥ 100		

### Important note

Notes

### Classifications

ETIM 8.0	EC003568	ETIM 9.0	EC003568
ETIM 10.0	EC003568	ECLASS 14.0	27-44-01-10
ECLASS 15.0	27-44-01-10		

**Drawings**

**Dimensioned drawing**

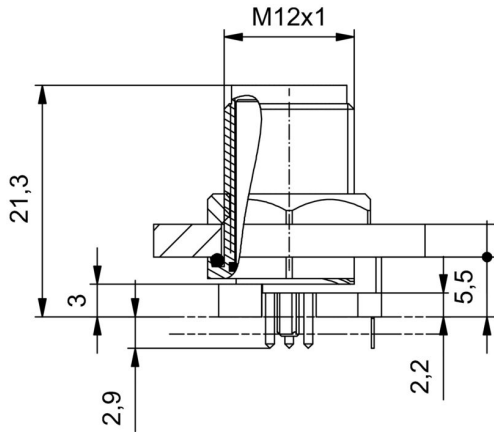

L (board-to-board distance) = 5.5mm

**PCB design**

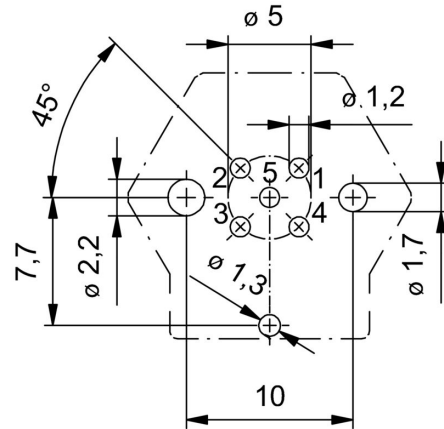

**Front panel section**

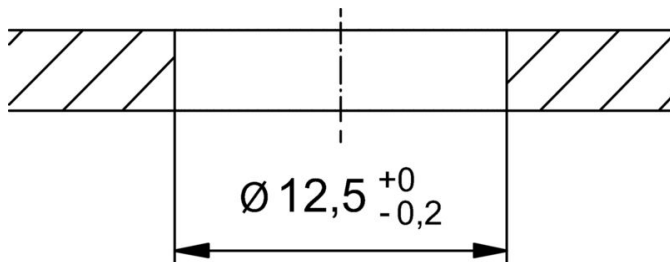

**Pole scheme**

