

BCL-SMT 3.81/02/180 1.5SN BK BX

Weidmüller Interface GmbH & Co. KG
 Klingenbergstraße 26
 D-32758 Detmold
 Germany

www.weidmueller.com

Product image

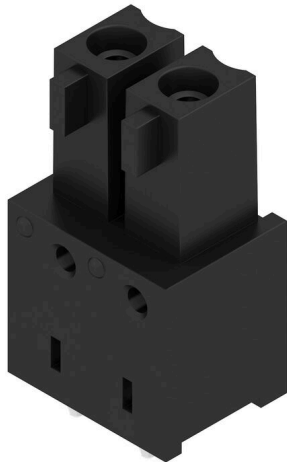

The inverted BCL-SMT socket block for the PCB offers three significant advantages:

- The BCL-SMT offers touch-safe security on the PCB which makes it ideal for live, current-carrying outputs.
- The BCL-SMT widens the range of applications with board-to-board connections between component assemblies.
- The BCL-SMT is reflow-compatible and can be seamlessly integrated into the automatic assembly and soldering process.

Two outlet directions give you a choice of position and thus more design flexibility.

- 180° standing
- 90° recumbent

Two housing variants are available for the BCL-SMT:

- Without flange
- With inverted solder flange ("LFI", with nut)
 - Fastened to PCB without additional screw
 - Fastened with screw to the SCZ FI

Weidmüller's 3.81-mm-pitch (0.15 inch) plug-in connectors are compatible with the layouts of customary connectors and offer space for labelling and coding.

General ordering data

Version	PCB plug-in connector, female header, closed side, THT/THR solder connection, 3.81 mm, Number of poles: 2, 180°, Solder pin length (l): 1.5 mm, tinned, black, Box
Order No.	1976490000
Type	BCL-SMT 3.81/02/180 1.5SN BK BX
GTIN (EAN)	4032248678983
Qty.	50 items
Product data	IEC: 320 V / 17.5 A UL: 300 V / 10 A
Packaging	Box

BCL-SMT 3.81/02/180 1.5SN BK BX

Weidmüller Interface GmbH & Co. KG
Klingenbergstraße 26
D-32758 Detmold
Germany

www.weidmueller.com

Technical data

Approvals

Approvals



ROHS	Conform
UL File Number Search	UL Website
Certificate No. (cURus)	E60693

Dimensions and weights

Net weight	0.74 g
------------	--------

Environmental Product Compliance

RoHS Compliance Status	Compliant without exemption
REACH SVHC	No SVHC above 0.1 wt%

System specifications

Product family	OMNIMATE Signal - series BC/SC 3.81	Type of connection	Board connection
Mounting onto the PCB	THT/THR solder connection	Pitch in mm (P)	3.81 mm
Pitch in inches (P)	0.150 "	Outgoing elbow	180°
Number of poles	2	Number of solder pins per pole	2
Solder pin length (l)	1.5 mm	Solder pin length tolerance	0 / -0,02 mm
Solder pin dimensions	d = 0.8 mm	Solder pin dimensions = d tolerance	+0,05 / -0,05 mm
Solder eyelet hole diameter (D)	1.2 mm	Solder eyelet hole diameter tolerance (D)	+ 0,1 mm
Outside diameter of solder pad	1.9 mm	Template aperture diameter	1.6 mm
L1 in mm	3.81 mm	L1 in inches	0.150 "
Number of rows	1	Pin series quantity	1
Touch-safe protection acc. to DIN VDE 57 106	Safe from back-of-hand touch	Touch-safe protection acc. to DIN VDE 0470	IP20 plugged
Volume resistance	≤5 mΩ	Can be coded	Yes
Plugging force/pole, max.	9.5 N	Pulling force/pole, max.	6 N

Material data

Insulating material	LCP GF	Colour	black
Colour chart (similar)	RAL 9011	Insulating material group	IIla
Comparative Tracking Index (CTI)	≥ 175	Moisture Level (MSL)	1
UL 94 flammability rating	V-0	Contact material	Cu-alloy
Contact surface	tinned	Layer structure of solder connection	1...3 μm Ni / 2...4 μm Sn matt
Layer structure of plug contact	1...3 μm Ni / 2...4 μm Sn matt	Storage temperature, min.	-40 °C
Storage temperature, max.	70 °C	Operating temperature, min.	-50 °C
Operating temperature, max.	120 °C	Temperature range, installation, min.	-25 °C
Temperature range, installation, max.	120 °C		

Rated data acc. to IEC

tested acc. to standard	IEC 60664-1, IEC 61984	Rated current, min. number of poles (Tu=20°C)	17.5 A
Rated current, max. number of poles (Tu=20°C)	15.4 A	Rated current, min. number of poles (Tu=40°C)	17.5 A

BCL-SMT 3.81/02/180 1.5SN BK BX

Weidmüller Interface GmbH & Co. KG
 Klingenbergstraße 26
 D-32758 Detmold
 Germany

www.weidmueller.com

Technical data

Rated current, max. number of poles (Tu=40°C)	13.8 A	Rated voltage for surge voltage class / pollution degree II/2	320 V
Rated voltage for surge voltage class / pollution degree III/2	160 V	Rated voltage for surge voltage class / pollution degree III/3	160 V
Rated impulse voltage for surge voltage class/ pollution degree II/2	2.5 kV	Rated impulse voltage for surge voltage class/ pollution degree III/2	2.5 kV
Rated impulse voltage for surge voltage class/ contamination degree III/3	2.5 kV	Short-time withstand current resistance	3 x 1s with 76 A

Rated data acc. to CSA

Rated voltage (Use group B / CSA)	300 V	Rated voltage (Use group C / CSA)	50 V
Rated current (Use group B / CSA)	11 A	Rated current (Use group C / CSA)	11 A

Rated data acc. to UL 1059

Institute (cURus)	CURUS	Certificate No. (cURus)	E60693
Rated voltage (Use group B / UL 1059)	300 V	Rated voltage (Use group D / UL 1059)	300 V
Rated current (Use group B / UL 1059)	10 A	Rated current (Use group D / UL 1059)	10 A
Reference to approval values	Specifications are maximum values, details - see approval certificate.		

Packing

Packaging	Box	VPE length	108.00 mm
VPE width	65.00 mm	VPE height	25.00 mm

Important note

IPC conformity	Conformity: The products are developed, manufactured and delivered according international recognized standards and norms and comply with the assured properties in the data sheet resp. fulfill decorative properties in accordance with IPC-A-610 "Class 2". Further claims on the products can be evaluated on request.
Notes	<ul style="list-style-type: none"> Rated current related to rated cross-section & min. No. of poles. P on drawing = pitch Rated data refer only to the component itself. Clearance and creepage distances to other components are to be designed in accordance with the relevant application standards. In accordance with IEC 61984, OMNIMATE-connectors are connectors without breaking capacity (COC). During designated use, connectors are not allowed to be engaged or disengaged when live or under load Long term storage of the product with average temperature of 50 °C and maximum humidity 70%, 36 months

Classifications

ETIM 8.0	EC002637	ETIM 9.0	EC002637
ETIM 10.0	EC002637	ECLASS 14.0	27-46-02-01
ECLASS 15.0	27-46-02-01		

BCL-SMT 3.81/02/180 1.5SN BK BX

Weidmüller Interface GmbH & Co. KG
 Klingenbergstraße 26
 D-32758 Detmold
 Germany

Drawings

www.weidmueller.com

Product image



Dimensional drawing

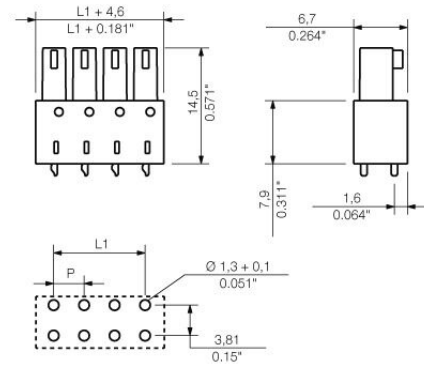

Graph



Graph



BCL-SMT 3.81/02/180 1.5SN BK BX

Weidmüller Interface GmbH & Co. KG
 Klingenbergstraße 26
 D-32758 Detmold
 Germany

Counterpart

www.weidmueller.com

SC 3.81/135G



The SC pin header with 135° wire outlet direction: the 135° angle exists between the plugging direction and the solder pin. The wire outlet direction is then diagonal or 45° to the PCB.

- More freedom when designing components and devices.
 - Easy access and a high component density when multiple interfaces are arranged in parallel within a single plugging area
 - The housing design is application-friendly because of the additional optional wire outlet direction.
 - Available in closed (G) and screw flange (F) versions.
- Weidmüller's 3.81-mm-pitch (0.15 inch) plug-in connectors are compatible with the layouts of standard connectors and offer space for labelling and coding.

General ordering data

Type	SC 3.81/02/135G 3.2SN B...	Version
Order No.	1976380000	PCB plug-in connector, male header, closed side, THT solder connection, 3.81 mm, Number of poles: 2, 135°, Solder pin length (l):
GTIN (EAN)	4032248684502	3.2 mm, tinned, black, Box
Qty.	50 ST	
Type	SC 3.81/02/135G 3.2SN G...	Version
Order No.	1976010000	PCB plug-in connector, male header, closed side, THT solder connection, 3.81 mm, Number of poles: 2, 135°, Solder pin length (l):
GTIN (EAN)	4032248684359	3.2 mm, tinned, Pale green, Box
Qty.	50 ST	
Type	SC 3.81/02/135G 3.2SN O...	Version
Order No.	1975720000	PCB plug-in connector, male header, closed side, THT solder connection, 3.81 mm, Number of poles: 2, 135°, Solder pin length (l):
GTIN (EAN)	4032248684144	3.2 mm, tinned, orange, Box
Qty.	50 ST	

SC 3.81/180G

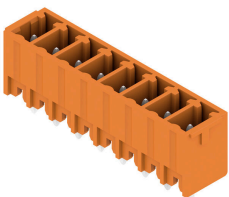

The SC pin header has a perpendicular (standing) plugging direction in relation to the PCB. It is available in closed (G) and screw flange (F) versions.

Weidmüller's 3.81-mm-pitch (0.15 inch) plug-in connectors are compatible with the layouts of standard connectors and offer space for labelling and coding.

General ordering data

Type	SC 3.81/02/180G 3.2SN O...	Version
Order No.	1942840000	PCB plug-in connector, male header, closed side, THT solder connection, 3.81 mm, Number of poles: 2, 180°, Solder pin length (l):
GTIN (EAN)	4032248654758	3.2 mm, tinned, orange, Box
Qty.	198 ST	
Type	SC 3.81/02/180G 3.2SN G...	Version
Order No.	1793610000	PCB plug-in connector, male header, closed side, THT solder connection, 3.81 mm, Number of poles: 2, 180°, Solder pin length (l):
GTIN (EAN)	4032248230730	3.2 mm, tinned, Pale green, Box
Qty.	198 ST	

BCL-SMT 3.81/02/180 1.5SN BK BX

Weidmüller Interface GmbH & Co. KG
 Klingenbergstraße 26
 D-32758 Detmold
 Germany

www.weidmueller.com

Counterpart

Type	SC 3.81/02/180G 3.2SN B...	Version
Order No.	1793520000	PCB plug-in connector, male header, closed side, THT solder
GTIN (EAN)	4032248230433	connection, 3.81 mm, Number of poles: 2, 180°, Solder pin length (l):
Qty.	50 ST	3.2 mm, tinned, black, Box

SC 3.81/270G

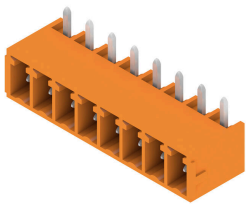

The SC pin header in 270°-outlet direction: the 270° angle exists between the plugging direction and the solder pin. The plugging direction is then parallel to the PCB. Sockets blocks, however, have an overhead plugging angle.

- More freedom when designing components and devices.
- A high component density when multiple PCBs are arranged in parallel within one housing
- The housing design is application-friendly because of the additional optional wire outlet direction.
- Available in closed (G) and screw flange (F) versions. Weidmüller's 3.81-mm-pitch (0.15 inch) plug-in connectors are compatible with the layouts of standard connectors and offer space for labelling and coding.

General ordering data

Type	SC 3.81/02/270G 3.2SN O...	Version
Order No.	1037490000	PCB plug-in connector, male header, closed side, THT solder
GTIN (EAN)	4032248766123	connection, 3.81 mm, Number of poles: 2, 270°, Solder pin length (l):
Qty.	50 ST	3.2 mm, tinned, orange, Box

SC 3.81/90G

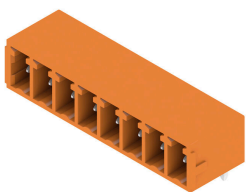

The SC pin header has a parallel (recumbent) plugging direction in relation to the PCB. It is available in closed (G) and screw flange (F) versions.

Weidmüller's 3.81-mm-pitch (0.15 inch) plug-in connectors are compatible with the layouts of standard connectors. They support a flood-light display and offer space for labelling and coding.

General ordering data

Type	SC 3.81/02/90G 3.2SN OR...	Version
Order No.	1942020000	PCB plug-in connector, male header, closed side, THT solder
GTIN (EAN)	4032248655526	connection, 3.81 mm, Number of poles: 2, 90°, Solder pin length (l):
Qty.	198 ST	3.2 mm, tinned, orange, Box
Type	SC 3.81/02/90G 3.2SN GN...	Version
Order No.	1793240000	PCB plug-in connector, male header, closed side, THT solder
GTIN (EAN)	4032248227716	connection, 3.81 mm, Number of poles: 2, 90°, Solder pin length (l):
Qty.	198 ST	3.2 mm, tinned, Pale green, Box
Type	SC 3.81/02/90G 3.2SN BK...	Version
Order No.	1793130000	PCB plug-in connector, male header, closed side, THT solder
GTIN (EAN)	4032248227624	connection, 3.81 mm, Number of poles: 2, 90°, Solder pin length (l):
Qty.	198 ST	3.2 mm, tinned, black, Box

BCL-SMT 3.81/02/180 1.5SN BK BX

Weidmüller Interface GmbH & Co. KG
Klingenbergstraße 26
D-32758 Detmold
Germany

Counterpart

www.weidmueller.com

SCD 3.81/180G

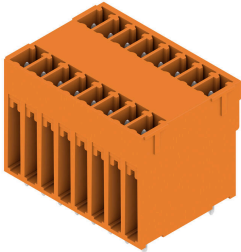

Two-tier SCD pin header for wave soldering.

- It allows you to use two interfaces on only one surface and with only one step in the work flow.
- Outlet direction: 180° (standing).
- Connections at the same level and with access that is flush over the front board.
- Space for labelling and coding
- Packed in cardboard box.

Weidmüller's 3.81-mm-pitch (0.15 inch) plug-in connectors are compatible with the layouts of standard connectors and offer space for labelling and coding.

General ordering data

Type	SCD 3.81/04/180G 3.2SN ...	Version
Order No.	1030260000	PCB plug-in connector, male header, closed side, THT solder
GTIN (EAN)	4032248759439	connection, 3.81 mm, Number of poles: 4, 180°, Solder pin length (l):
Qty.	132 ST	3.2 mm, tinned, black, Box
Type	SCD 3.81/04/180G 3.2SN ...	Version
Order No.	1030090000	PCB plug-in connector, male header, closed side, THT solder
GTIN (EAN)	4032248759217	connection, 3.81 mm, Number of poles: 4, 180°, Solder pin length (l):
Qty.	132 ST	3.2 mm, tinned, Pale green, Box

SCD 3.81/90G

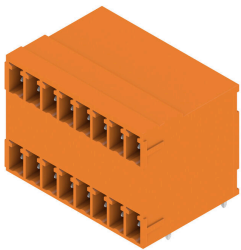

Two-tier SCD pin header for wave soldering.

- It allows you to use two interfaces on only one surface and with only one step in the work flow.
- Outlet direction: 90° (recumbent)
- Connections at the same level and with access that is flush over the front board.
- Space for labelling and coding
- Packed in cardboard box.

Weidmüller's 3.81-mm-pitch (0.15 inch) plug-in connectors are compatible with the layouts of standard connectors and offer space for labelling and coding.

General ordering data

Type	SCD 3.81/04/90G 3.2SN G...	Version
Order No.	1972940000	PCB plug-in connector, male header, closed side, THT solder
GTIN (EAN)	4032248682515	connection, 3.81 mm, Number of poles: 4, 90°, Solder pin length (l):
Qty.	50 ST	3.2 mm, tinned, Pale green, Box
Type	SCD 3.81/04/90G 3.2SN O...	Version
Order No.	1972790000	PCB plug-in connector, male header, closed side, THT solder
GTIN (EAN)	4032248682362	connection, 3.81 mm, Number of poles: 4, 90°, Solder pin length (l):
Qty.	132 ST	3.2 mm, tinned, orange, Box

BCL-SMT 3.81/02/180 1.5SN BK BX

Weidmüller Interface GmbH & Co. KG
 Klingenbergstraße 26
 D-32758 Detmold
 Germany

Counterpart

www.weidmueller.com

SCDN 3.81/90G

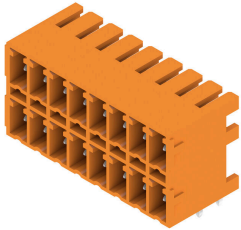

Extra flat two-tier SCDN pin header for wave soldering.

- Two compact interfaces are used with the flat BCF 3.81 (PUSH IN) socket block.
- Available as 90° (recumbent).
- Connections on a single level, allowing access that is flush over the front board.
- Space for labelling and coding
- Packed in cardboard box.

Weidmüller's 3.81-mm-pitch (0.15 inch) plug-in connectors are compatible with the layouts of standard connectors and offer space for labelling and coding.

General ordering data

Type	SCDN 3.81/04/90G 3.2SN ...	Version
Order No.	1040790000	PCB plug-in connector, male header, closed side, THT solder
GTIN (EAN)	4032248769650	connection, 3.81 mm, Number of poles: 4, 90°, Solder pin length (l):
Qty.	50 ST	3.2 mm, tinned, black, Box
Type	SCDN 3.81/04/90G 3.2SN ...	Version
Order No.	1040410000	PCB plug-in connector, male header, closed side, THT solder
GTIN (EAN)	4032248769070	connection, 3.81 mm, Number of poles: 4, 90°, Solder pin length (l):
Qty.	50 ST	3.2 mm, tinned, orange, Box

SCDV 3.81/180G



Two-tier SCDV pin header for wave soldering.

- It allows you to use two interfaces on only one surface and with only one step in the work flow.
- Outlet direction: 180° (standing).
- Connections at two offset levels and open access to each row.
- Space for labelling and coding
- Packed in cardboard box.

Weidmüller's 3.81-mm-pitch (0.15 inch) plug-in connectors are compatible with the layouts of standard connectors and offer space for labelling and coding.

General ordering data

Type	SCDV 3.81/04/180G 3.2SN...	Version
Order No.	1034470000	PCB plug-in connector, male header, closed side, THT solder
GTIN (EAN)	4032248763313	connection, 3.81 mm, Number of poles: 4, 180°, Solder pin length (l):
Qty.	50 ST	3.2 mm, tinned, orange, Box

BCL-SMT 3.81/02/180 1.5SN BK BX

Weidmüller Interface GmbH & Co. KG
 Klingenbergstraße 26
 D-32758 Detmold
 Germany

www.weidmueller.com

Counterpart

SCDV 3.81/90G

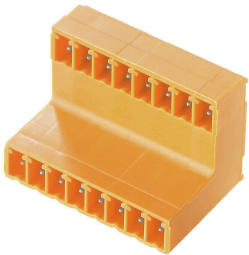

Two-tier SCDV pin header for wave soldering.

- It allows you to use two interfaces on only one surface and with only one step in the work flow.
- Outlet direction: 90° (recumbent)
- Connections at two offset levels and with open access to each row.
- Space for labelling and coding
- Packed in cardboard box.

Weidmüller's 3.81-mm-pitch (0.15 inch) plug-in connectors are compatible with the layouts of standard connectors and offer space for labelling and coding.

General ordering data

Type	SCDV 3.81/04/90G 3.2SN ...	Version
Order No.	1032260000	PCB plug-in connector, male header, closed side, THT solder
GTIN (EAN)	4032248771554	connection, 3.81 mm, Number of poles: 4, 90°, Solder pin length (l):
Qty.	50 ST	3.2 mm, tinned, Pale green, Box
Type	SCDV 3.81/04/90G 3.2SN ...	Version
Order No.	1032090000	PCB plug-in connector, male header, closed side, THT solder
GTIN (EAN)	4032248771400	connection, 3.81 mm, Number of poles: 4, 90°, Solder pin length (l):
Qty.	50 ST	3.2 mm, tinned, orange, Box

SC-SMT 3.81/135G

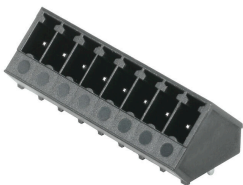

The high-temperature-resistant SC-SMT pin header with 135° wire outlet direction: the 135° angle exists between the plugging direction and the solder pin. The wire outlet direction is then diagonal or 45° to the PCB.

- More freedom when designing components and devices.
- Easy access and a high component density when multiple interfaces are arranged in parallel within a single plugging area
- The housing design is application-friendly because of the additional optional wire outlet direction.
- Available as closed (G) and with solder flange (LF).
- Pin length of either 1.5 mm or 3.2 mm

Weidmüller's 3.81-mm-pitch (0.15 inch) plug-in connectors are compatible with the layouts of standard connectors and offer space for labelling and coding.

General ordering data

Type	SC-SMT 3.81/02/135G 3.2...	Version
Order No.	1977200000	PCB plug-in connector, male header, closed side, THT/THR solder
GTIN (EAN)	4032248685219	connection, 3.81 mm, Number of poles: 2, 135°, Solder pin length (l):
Qty.	50 ST	3.2 mm, tinned, black, Box

BCL-SMT 3.81/02/180 1.5SN BK BX

Weidmüller Interface GmbH & Co. KG
 Klingenbergstraße 26
 D-32758 Detmold
 Germany

www.weidmueller.com

Counterpart

SC-SMT 3.81/180G Box



High-temperature-resistant pin header (SC-SMT 180G) in 3.81-mm pitch (0.15 inch)

- Plugging direction is perpendicular to PCB (standing)
- Closed (G) .
- Packed either in box (BX) or on anti-static roll (tape-on-reel, RL)

• Pin length of either 1.5 mm or 3.2 mm
 Weidmüller's 3.81-mm-pitch (0.15 inch) plug-in connectors are compatible with the layouts of standard connectors and offer space for labelling and coding.

General ordering data

Type	SC-SMT 3.81/02/180G 1.5...	Version
Order No.	1863720000	PCB plug-in connector, male header, closed side, THT/THR solder connection, 3.81 mm, Number of poles: 2, 180°, Solder pin length (l):
GTIN (EAN)	4032248428793	
Qty.	50 ST	1.5 mm, tinned, black, Box

Type	SC-SMT 3.81/02/180G 3.2...	Version
Order No.	1862920000	PCB plug-in connector, male header, closed side, THT/THR solder connection, 3.81 mm, Number of poles: 2, 180°, Solder pin length (l):
GTIN (EAN)	4032248428113	
Qty.	50 ST	3.2 mm, tinned, black, Box

SC-SMT 3.81/180G Tape

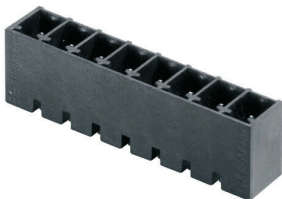

High-temperature-resistant pin header (SC-SMT 180G) in 3.81-mm pitch (0.15 inch)

- Plugging direction is perpendicular to PCB (standing)
- Closed (G) .
- Packed either in box (BX) or on anti-static roll (tape-on-reel, RL)

• Pin length of either 1.5 mm or 3.2 mm
 Weidmüller's 3.81-mm-pitch (0.15 inch) plug-in connectors are compatible with the layouts of standard connectors and offer space for labelling and coding.

General ordering data

Type	SC-SMT 3.81/02/180G 1.5...	Version
Order No.	1864050000	PCB plug-in connector, male header, closed side, THT/THR solder connection, 3.81 mm, Number of poles: 2, 180°, Solder pin length (l):
GTIN (EAN)	4032248429172	
Qty.	300 ST	1.5 mm, tinned, black, Tape

BCL-SMT 3.81/02/180 1.5SN BK BX

Weidmüller Interface GmbH & Co. KG
 Klingenbergstraße 26
 D-32758 Detmold
 Germany

Counterpart

www.weidmueller.com

SC-SMT 3.81/270G

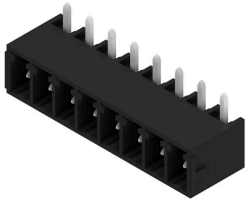

The SC-SMT pin header in 270°-outlet direction: the 270° angle exists between the plugging direction and the solder pin. The plugging direction is then parallel to the PCB. Sockets blocks, however, have an overhead plugging angle.

- More freedom when designing components and devices.
- A high component density when multiple PCBs are arranged in parallel within one housing
- The housing design is application-friendly because of the additional optional wire outlet direction.
- Available in closed (G) and screw flange (F) versions.
- Pin length of either 1.5 mm or 3.2 mm

Weidmüller's 3.81-mm-pitch (0.15 inch) plug-in connectors are compatible with the layouts of standard connectors and offer space for labelling and coding.

General ordering data

Type	SC-SMT 3.81/02/270G 3.2...	Version
Order No.	1036480000	PCB plug-in connector, male header, closed side, THT/THR solder
GTIN (EAN)	4032248765089	connection, 3.81 mm, Number of poles: 2, 270°, Solder pin length (l):
Qty.	50 ST	3.2 mm, tinned, black, Box

SC-SMT 3.81/90G Box

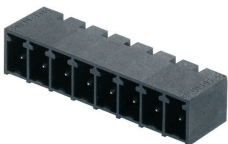

High-temperature-resistant pin header (SC-SMT 90G) in 3.81-mm pitch (0.15 inch)

- Plugging direction parallel to PCB (recumbent)
- Closed (G)
- Packed either in box (BX) or on anti-static roll (tape-on-reel, RL)
- Pin length of either 1.5 mm or 3.2 mm

Weidmüller's 3.81-mm-pitch (0.15 inch) plug-in connectors are compatible with the layouts of standard connectors and offer space for labelling and coding.

General ordering data

Type	SC-SMT 3.81/02/90G 1.5S...	Version
Order No.	1862960000	PCB plug-in connector, male header, closed side, THT/THR solder
GTIN (EAN)	4032248428069	connection, 3.81 mm, Number of poles: 2, 90°, Solder pin length (l):
Qty.	50 ST	1.5 mm, tinned, black, Box
Type	SC-SMT 3.81/02/90G 3.2S...	Version
Order No.	1862460000	PCB plug-in connector, male header, closed side, THT/THR solder
GTIN (EAN)	4032248427611	connection, 3.81 mm, Number of poles: 2, 90°, Solder pin length (l):
Qty.	50 ST	3.2 mm, tinned, black, Box

BCL-SMT 3.81/02/180 1.5SN BK BX

Weidmüller Interface GmbH & Co. KG
 Klingenbergstraße 26
 D-32758 Detmold
 Germany

Counterpart

www.weidmueller.com

SC-SMT 3.81/90G Tape



High-temperature-resistant pin header (SC-SMT 90G) in 3.81-mm pitch (0.15 inch)

- Plugging direction parallel to PCB (recumbent)
- Closed (G)
- Packed either in box (BX) or on anti-static roll (tape-on-reel, RL)

• Pin length of either 1.5 mm or 3.2 mm
 Weidmüller's 3.81-mm-pitch (0.15 inch) plug-in connectors are compatible with the layouts of standard connectors and offer space for labelling and coding.

General ordering data

Type	SC-SMT 3.81/02/90G 1.5S...	Version
Order No.	1863140000	PCB plug-in connector, male header, closed side, THT/THR solder connection, 3.81 mm, Number of poles: 2, 90°, Solder pin length (l):
GTIN (EAN)	4032248428335	1.5 mm, tinned, black, Tape
Qty.	400 ST	
Type	SC-SMT 3.81/02/90G 3.2S...	Version
Order No.	1862810000	PCB plug-in connector, male header, closed side, THT/THR solder connection, 3.81 mm, Number of poles: 2, 90°, Solder pin length (l):
GTIN (EAN)	4032248427772	3.2 mm, tinned, black, Tape
Qty.	400 ST	

SCD-THR 3.81/180G



High-temperature-resistant two-tier SCD-THR pin header for reflow soldering.

- It allows you to use two interfaces on only one surface and with only one step in the work flow.
- Outlet direction: 90° (recumbent)
- Connections at the same level and with access that is flush over the front board.
- Space for labelling and coding
- Packed in cardboard box.

Weidmüller's 3.81-mm-pitch (0.15 inch) plug-in connectors are compatible with the layouts of standard connectors and offer space for labelling and coding.

General ordering data

Type	SCD-THR 3.81/04/180G 1....	Version
Order No.	1031290000	PCB plug-in connector, male header, closed side, THT/THR solder connection, 3.81 mm, Number of poles: 4, 180°, Solder pin length (l):
GTIN (EAN)	4032248760336	1.5 mm, tinned, black, Box
Qty.	50 ST	
Type	SCD-THR 3.81/04/180G 3...	Version
Order No.	1030950000	PCB plug-in connector, male header, closed side, THT/THR solder connection, 3.81 mm, Number of poles: 4, 180°, Solder pin length (l):
GTIN (EAN)	4032248760039	3.2 mm, tinned, black, Box
Qty.	50 ST	

BCL-SMT 3.81/02/180 1.5SN BK BX

Weidmüller Interface GmbH & Co. KG
 Klingenbergstraße 26
 D-32758 Detmold
 Germany

www.weidmueller.com

Counterpart

SCD-THR 3.81/90G



High-temperature-resistant two-tier SCD-THR pin header for reflow soldering.

- It allows you to use two interfaces on only one surface and with only one step in the work flow.
- Outlet direction: 90° (recumbent)
- Connections at the same level and with access that is flush over the front board.
- Space for labelling and coding
- Packed in cardboard box.

Weidmüller's 3.81-mm-pitch (0.15 inch) plug-in connectors are compatible with the layouts of standard connectors and offer space for labelling and coding.

General ordering data

Type	SCD-THR 3.81/04/90G 1.5...	Version
Order No.	1974030000	PCB plug-in connector, male header, closed side, THT/THR solder connection, 3.81 mm, Number of poles: 4, 90°, Solder pin length (l):
GTIN (EAN)	4032248683543	1.5 mm, tinned, black, Box
Qty.	50 ST	
Type	SCD-THR 3.81/04/90G 3.2...	Version
Order No.	1973730000	PCB plug-in connector, male header, closed side, THT/THR solder connection, 3.81 mm, Number of poles: 4, 90°, Solder pin length (l):
GTIN (EAN)	4032248683246	3.2 mm, tinned, black, Box
Qty.	50 ST	

SCDN-THR 3.81/90G



Extra flat high-temperature-resistant two-tier SCDN-THR pin header for reflow soldering.

- Two compact interfaces are used with the flat BCF 3.81 (PUSH IN) socket block.
- Available as 90° (recumbent).
- Connections on a single level, allowing access that is flush over the front board.
- Space for labelling and coding
- Packed in cardboard box.

Weidmüller's 3.81-mm-pitch (0.15 inch) plug-in connectors are compatible with the layouts of standard connectors and offer space for labelling and coding.

General ordering data

Type	SCDN-THR 3.81/04/90G 1...	Version
Order No.	1039270000	PCB plug-in connector, male header, closed side, THT/THR solder connection, 3.81 mm, Number of poles: 4, 90°, Solder pin length (l):
GTIN (EAN)	4032248772599	1.5 mm, tinned, black, Box
Qty.	50 ST	
Type	SCDN-THR 3.81/04/90G 3...	Version
Order No.	1038950000	PCB plug-in connector, male header, closed side, THT/THR solder connection, 3.81 mm, Number of poles: 4, 90°, Solder pin length (l):
GTIN (EAN)	4032248767601	3.2 mm, tinned, black, Box
Qty.	50 ST	

BCL-SMT 3.81/02/180 1.5SN BK BX

Weidmüller Interface GmbH & Co. KG
 Klingenbergstraße 26
 D-32758 Detmold
 Germany

www.weidmueller.com

Counterpart

SCDV-THR 3.81/180G



High-temperature-resistant two-tier SCDV-THR pin header for reflow soldering.

- It allows you to use two interfaces on only one surface and with only one step in the work flow.
- Outlet direction: 90° (recumbent)
- Connections at two offset levels and open access to each row.
- Space for labelling and coding
- Packed in cardboard box.

Weidmüller's 3.81-mm-pitch (0.15 inch) plug-in connectors are compatible with the layouts of standard connectors and offer space for labelling and coding.

General ordering data

Type	SCDV-THR 3.81/04/180G 1...	Version
Order No.	1035790000	PCB plug-in connector, male header, closed side, THT/THR solder connection, 3.81 mm, Number of poles: 4, 180°, Solder pin length (l):
GTIN (EAN)	4032248763887	
Qty.	50 ST	1.5 mm, tinned, black, Box
Type	SCDV-THR 3.81/04/180G 3...	Version
Order No.	1035470000	PCB plug-in connector, male header, closed side, THT/THR solder connection, 3.81 mm, Number of poles: 4, 180°, Solder pin length (l):
GTIN (EAN)	4032248764235	
Qty.	50 ST	3.2 mm, tinned, black, Box

SCDV-THR 3.81/90G

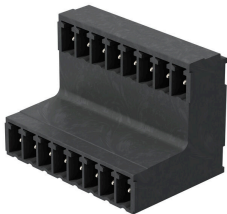

High-temperature-resistant two-tier SCDV-THR pin header for reflow soldering.

- It allows you to use two interfaces on only one surface and with only one step in the work flow.
- Outlet direction: 90° (recumbent)
- Connections at two offset levels and open access to each row.
- Space for labelling and coding
- Packed in cardboard box.

Weidmüller's 3.81-mm-pitch (0.15 inch) plug-in connectors are compatible with the layouts of standard connectors and offer space for labelling and coding.

General ordering data

Type	SCDV-THR 3.81/04/90G 1...	Version
Order No.	1033820000	PCB plug-in connector, male header, closed side, THT/THR solder connection, 3.81 mm, Number of poles: 4, 90°, Solder pin length (l):
GTIN (EAN)	4032248762712	
Qty.	50 ST	1.5 mm, tinned, black, Box
Type	SCDV-THR 3.81/04/90G 3...	Version
Order No.	1033490000	PCB plug-in connector, male header, closed side, THT/THR solder connection, 3.81 mm, Number of poles: 4, 90°, Solder pin length (l):
GTIN (EAN)	4032248762415	
Qty.	50 ST	3.2 mm, tinned, black, Box

BCL-SMT 3.81/02/180 1.5SN BK BX

Weidmüller Interface GmbH & Co. KG
 Klingenbergstraße 26
 D-32758 Detmold
 Germany

www.weidmueller.com

Counterpart

SCZ 3.81/180G

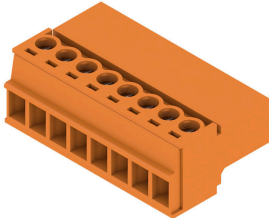

The inverted SCZ pin plug with clamping-yoke screw connection is designed for straight wire connections in 3.81-mm pitch. It can be used in two ways:

- for wire-to-wire connections together with the BCZ
- as a mating plug for the touch-safe BCL socket block on the PCB.

The SCZ is available in four different versions:

- Without flange ("G", closed)
- With standard flange ("F", with socket nut)
- With inverted flange ("FI", with screw)
- and with Weidmüller's patented release latch for a tool-free, no-strain disconnect

The SCZ provides space for labelling and can be coded.

General ordering data

Type	SCZ 3.81/02/180G SN GN ...	Version
Order No.	1969750000	PCB plug-in connector, male plug, 3.81 mm, Number of poles: 2,
GTIN (EAN)	4032248679287	180°, Clamping yoke connection, Clamping range, max. : 1.5 mm ² ,
Qty.	50 ST	Box
Type	SCZ 3.81/02/180G SN OR ...	Version
Order No.	1969520000	PCB plug-in connector, male plug, 3.81 mm, Number of poles: 2,
GTIN (EAN)	4032248679133	180°, Clamping yoke connection, Clamping range, max. : 1.5 mm ² ,
Qty.	50 ST	Box
Type	SCZ 3.81/02/180G SN BK ...	Version
Order No.	1970010000	PCB plug-in connector, male plug, 3.81 mm, Number of poles: 2,
GTIN (EAN)	4032248679430	180°, Clamping yoke connection, Clamping range, max. : 1.5 mm ² ,
Qty.	50 ST	Box