

## BLZP 5.08HC/05/270F SN BK BX

**Weidmüller Interface GmbH & Co. KG**  
 Klingenbergstraße 26  
 D-32758 Detmold  
 Germany

www.weidmueller.com

### Product image

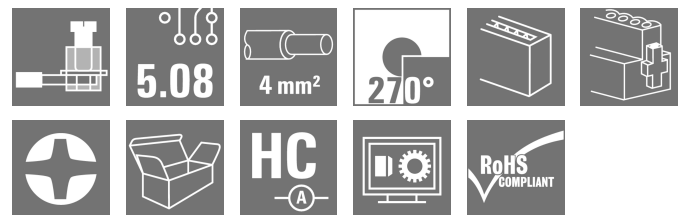

Female plugs with clamping-yoke connection for connecting wires with a right-angle (90° or 270°) outlet direction. The female connectors provide space for labelling and can be coded. Fastened by means of a flange or release latch. They also provide an integrated plus/minus screw, protection against faulty insertion of the wire, and they are delivered with open clamping yokes. HC = High Current.

### General ordering data

Version	PCB plug-in connector, female plug, 5.08 mm, Number of poles: 5, 270°, Clamping yoke connection, Clamping range, max. : 4 mm², Box
Order No.	<a href="#">1950580000</a>
Type	BLZP 5.08HC/05/270F SN BK BX
GTIN (EAN)	4032248628711
Qty.	48 items
Product data	IEC: 400 V / 23 A / 0.2 - 4 mm² UL: 300 V / 20 A / AWG 26 - AWG 12
Packaging	Box

**BLZP 5.08HC/05/270F SN BK BX**

**Weidmüller Interface GmbH & Co. KG**  
 Klingenbergstraße 26  
 D-32758 Detmold  
 Germany

www.weidmueller.com

**Technical data**

**Approvals**

Approvals



ROHS	Conform
UL File Number Search	<a href="#">UL Website</a>
Certificate No. (cURus)	E60693

**Dimensions and weights**

Depth	27.1 mm	Depth (inches)	1.0669 inch
Height	14.1 mm	Height (inches)	0.5551 inch
Width	35.2 mm	Width (inches)	1.3858 inch
Net weight	10.08 g		

**Environmental Product Compliance**

RoHS Compliance Status	Compliant without exemption
REACH SVHC	No SVHC above 0.1 wt%

**System Parameters**

Product family	OMNIMATE Signal - series BL/SL 5.08		
Type of connection	Field connection		
Wire connection method	Clamping yoke connection		
Pitch in mm (P)	5.08 mm		
Pitch in inches (P)	0.200 "		
Conductor outlet direction	270°		
Number of poles	5		
L1 in mm	20.32 mm		
L1 in inches	0.800 "		
Number of rows	1		
Pin series quantity	1		
Rated cross-section	4 mm <sup>2</sup>		
Touch-safe protection acc. to DIN VDE 57 106	Safe from finger touch		
Touch-safe protection acc. to DIN VDE 0470	IP20 plugged/ IP10 unplugged		
Protection degree	IP20		
Volume resistance	≤5 mΩ		
Can be coded	Yes		
Stripping length	7 mm		
Clamping screw	M 2.5		
Screwdriver blade	0.6 x 3.5, PH 1, PZ 1		
Screwdriver blade standard	DIN 5264, ISO 8764/2-PH, ISO 8764/2-PZ		
Plugging cycles	25		
Plugging force/pole, max.	10 N		
Pulling force/pole, max.	9 N		
Tightening torque	Torque type		Wire connection
	Usage information		Tightening torque
			min. 0.4 Nm
	Usage information		max. 0.5 Nm
Torque type			Screw flange
Usage information		Tightening torque	
		min. 0.2 Nm	
Usage information		max. 0.25 Nm	

## BLZP 5.08HC/05/270F SN BK BX

**Weidmüller Interface GmbH & Co. KG**  
 Klingenbergstraße 26  
 D-32758 Detmold  
 Germany

www.weidmueller.com

## Technical data

### Material data

Insulating material	PBT	Colour	black
Colour chart (similar)	RAL 9011	Insulating material group	Illa
Comparative Tracking Index (CTI)	≥ 200	Moisture Level (MSL)	
UL 94 flammability rating	V-0	Contact material	Cu-alloy
Contact surface	tinned	Layer structure of plug contact	4...8 µm Sn hot-dip tinned
Storage temperature, min.	-40 °C	Storage temperature, max.	70 °C
Operating temperature, min.	-50 °C	Operating temperature, max.	100 °C
Temperature range, installation, min.	-25 °C	Temperature range, installation, max.	100 °C

### Conductors suitable for connection

Clamping range, min.	0.13 mm <sup>2</sup>
Clamping range, max.	4 mm <sup>2</sup>
Wire connection cross section AWG, min.	AWG 30
Wire connection cross section AWG, max.	AWG 12
Solid, min. H05(07) V-U	0.2 mm <sup>2</sup>
Solid, max. H05(07) V-U	4 mm <sup>2</sup>
Flexible, min. H05(07) V-K	0.2 mm <sup>2</sup>
Flexible, max. H05(07) V-K	4 mm <sup>2</sup>
w. plastic collar ferrule, DIN 46228 pt 4, min.	0.2 mm <sup>2</sup>
w. plastic collar ferrule, DIN 46228 pt 4, max.	2.5 mm <sup>2</sup>
w. wire end ferrule, DIN 46228 pt 1, min.	0.2 mm <sup>2</sup>
w. wire end ferrule, DIN 46228 pt 1, max.	4 mm <sup>2</sup>
Plug gauge in accordance with EN 60999 a x b; ø	2.8 mm x 2.4 mm

Clampable conductor	Cross-section for conductor connection wire end ferrule	nominal	0.5 mm <sup>2</sup>
		Stripping length	nominal 6 mm
		Recommended wire-end ferrule	<a href="#">H0,5/6</a>
		Stripping length	nominal 8 mm
	Cross-section for conductor connection wire end ferrule	nominal	1 mm <sup>2</sup>
		Stripping length	nominal 6 mm
		Recommended wire-end ferrule	<a href="#">H1,0/6</a>
		Stripping length	nominal 8 mm
	Cross-section for conductor connection wire end ferrule	nominal	1.5 mm <sup>2</sup>
		Stripping length	nominal 7 mm
		Recommended wire-end ferrule	<a href="#">H1,5/7</a>
		Stripping length	nominal 10 mm
	Cross-section for conductor connection wire end ferrule	nominal	2.5 mm <sup>2</sup>
		Stripping length	nominal 7 mm
		Recommended wire-end ferrule	<a href="#">H2,5/7</a>
		Stripping length	nominal 10 mm
	Cross-section for conductor connection wire end ferrule	nominal	2.5 mm <sup>2</sup>
		Stripping length	nominal 7 mm
		Recommended wire-end ferrule	<a href="#">H2,5/7</a>
		Stripping length	nominal 10 mm
Cross-section for conductor connection wire end ferrule	nominal	2.5 mm <sup>2</sup>	
	Stripping length	nominal 7 mm	
	Recommended wire-end ferrule	<a href="#">H2,5/7</a>	
	Stripping length	nominal 10 mm	

**Reference text** The outside diameter of the plastic collar should not be larger than the pitch (P). Length of ferrules is to be chosen depending on the product and the rated voltage.

**BLZP 5.08HC/05/270F SN BK BX**

**Weidmüller Interface GmbH & Co. KG**  
 Klingenbergstraße 26  
 D-32758 Detmold  
 Germany

www.weidmueller.com

**Technical data**

**Rated data acc. to IEC**

tested acc. to standard	IEC 60664-1, IEC 61984	Rated current, min. number of poles (Tu=20°C)	23 A
Rated current, max. number of poles (Tu=20°C)	18 A	Rated current, min. number of poles (Tu=40°C)	21 A
Rated current, max. number of poles (Tu=40°C)	16 A	Rated voltage for surge voltage class / pollution degree II/2	400 V
Rated voltage for surge voltage class / pollution degree III/2	320 V	Rated voltage for surge voltage class / pollution degree III/3	250 V
Rated impulse voltage for surge voltage class/ pollution degree II/2	4000 V	Rated impulse voltage for surge voltage class/ pollution degree III/2	4 kV
Rated impulse voltage for surge voltage class/ contamination degree III/3	4 kV	Short-time withstand current resistance	3 x 1s with 120 A

**Rated data acc. to CSA**

Institute (CSA)	CSA	Certificate No. (CSA)	200039-1121690
Rated voltage (Use group B / CSA)	300 V	Rated voltage (Use group C / CSA)	50 V
Rated voltage (Use group D / CSA)	300 V	Rated current (Use group B / CSA)	20 A
Rated current (Use group D / CSA)	20 A	Wire cross-section, AWG, min.	AWG 30
Wire cross-section, AWG, max.	AWG 12	Reference to approval values	Specifications are maximum values, details - see approval certificate.

**Rated data acc. to UL 1059**

Institute (cURus)	CURUS	Certificate No. (cURus)	E60693
Rated voltage (Use group B / UL 1059)	300 V	Rated voltage (Use group D / UL 1059)	300 V
Rated current (Use group B / UL 1059)	20 A	Rated current (Use group D / UL 1059)	10 A
Wire cross-section, AWG, min.	AWG 26	Wire cross-section, AWG, max.	AWG 12
Reference to approval values	Specifications are maximum values, details - see approval certificate.		

**Packing**

Packaging	Box	VPE length	348.00 mm
VPE width	138.00 mm	VPE height	32.00 mm

**Type tests**

Test: Durability of markings	Standard	DIN EN 61984 section 7.3.2 / 09.02 taking pattern from DIN EN 60068-2-70 / 07.96
	Test	mark of origin, rated voltage, rated cross-section, type of material
	Evaluation	available
	Test	durability
Test: Misengagement (Non-interchangeability)	Standard	DIN EN 60512-13-5 / 11.06, IEC 60512-13-5 / 02.06
	Test	180° turned with coding elements
	Evaluation	passed
	Test	visual examination
Test: Clampable cross section	Evaluation	passed
	Standard	DIN EN 60999-1 section 7 and 9.1 / 12.00, DIN EN 60947-1 section 8.2.4.5.1 / 12.02
	Conductor type	Type of conductor solid 0.2 mm <sup>2</sup> and conductor cross-section

**BLZP 5.08HC/05/270F SN BK BX**

**Weidmüller Interface GmbH & Co. KG**  
 Klingenbergstraße 26  
 D-32758 Detmold  
 Germany

www.weidmueller.com

**Technical data**

		Type of conductor and conductor cross-section	stranded 0.2 mm <sup>2</sup>	
		Type of conductor and conductor cross-section	solid 2.5 mm <sup>2</sup>	
		Type of conductor and conductor cross-section	stranded 2.5 mm <sup>2</sup>	
		Type of conductor and conductor cross-section	AWG 26/1	
		Type of conductor and conductor cross-section	AWG 26/19	
	Evaluation	passed		
Test for damage to and accidental loosening of conductors	Standard	DIN EN 60999-1 section 9.4 / 12.00		
	Requirement	0.2 kg		
	Conductor type	Type of conductor and conductor cross-section	AWG 26/1	
		Type of conductor and conductor cross-section	AWG 26/19	
	Evaluation	passed		
	Requirement	0.3 kg		
	Conductor type	Type of conductor and conductor cross-section	solid 0.5 mm <sup>2</sup>	
		Type of conductor and conductor cross-section	stranded 0.5 mm <sup>2</sup>	
	Evaluation	passed		
	Requirement	0.9 kg		
Pull-out test	Conductor type	Type of conductor and conductor cross-section	AWG 12/1	
		Type of conductor and conductor cross-section	AWG 12/19	
	Evaluation	passed		
	Standard	DIN EN 60999-1 section 9.5 / 12.00		
	Requirement	≥10 N		
	Conductor type	Type of conductor and conductor cross-section	AWG 26/1	
		Type of conductor and conductor cross-section	AWG 26/19	
	Evaluation	passed		
	Requirement	≥20 N		
	Conductor type	Type of conductor and conductor cross-section	H05V-U0.5	
Type of conductor and conductor cross-section		H05V-K0.5		
Evaluation	passed			
Requirement	≥60 N			
Conductor type	Type of conductor and conductor cross-section	H07V-U4.0		

## BLZP 5.08HC/05/270F SN BK BX

**Weidmüller Interface GmbH & Co. KG**  
 Klingenbergstraße 26  
 D-32758 Detmold  
 Germany

www.weidmueller.com

## Technical data

	Type of conductor and conductor cross-section	H07V-K4.0
	Type of conductor and conductor cross-section	AWG 12/1
	Type of conductor and conductor cross-section	AWG 12/19
Evaluation	passed	

### Important note

IPC conformity	Conformity: The products are developed, manufactured and delivered according international recognized standards and norms and comply with the assured properties in the data sheet resp. fulfill decorative properties in accordance with IPC-A-610 "Class 2". Further claims on the products can be evaluated on request.
Notes	<ul style="list-style-type: none"> <li>• Additional variants on request</li> <li>• Gold-plated contact surfaces on request</li> <li>• Rated current related to rated cross-section &amp; min. No. of poles.</li> <li>• Wire end ferrule without plastic collar to DIN 46228/1</li> <li>• Wire end ferrule with plastic collar to DIN 46228/4</li> <li>• P on drawing = pitch</li> <li>• Rated data refer only to the component itself. Clearance and creepage distances to other components are to be designed in accordance with the relevant application standards.</li> <li>• In accordance with IEC 61984, OMNIMATE-connectors are connectors without breaking capacity (COC). During designated use, connectors are not allowed to be engaged or disengaged when live or under load</li> <li>• Long term storage of the product with average temperature of 50 °C and maximum humidity 70%, 36 months</li> </ul>

### Classifications

ETIM 6.0	EC002638	ETIM 7.0	EC002638
ETIM 8.0	EC002638	ETIM 9.0	EC002638
ETIM 10.0	EC002638	ECLASS 9.0	27-44-03-09
ECLASS 9.1	27-44-03-09	ECLASS 10.0	27-44-03-09
ECLASS 11.0	27-46-02-02	ECLASS 12.0	27-46-02-02
ECLASS 13.0	27-46-02-02	ECLASS 14.0	27-46-02-02
ECLASS 15.0	27-46-02-02		

**BLZP 5.08HC/05/270F SN BK BX**

Weidmüller Interface GmbH & Co. KG  
Klingenbergstraße 26  
D-32758 Detmold  
Germany

[www.weidmueller.com](http://www.weidmueller.com)

Drawings

Product image

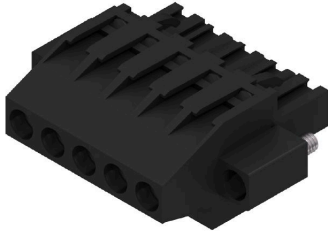

Dimensional drawing

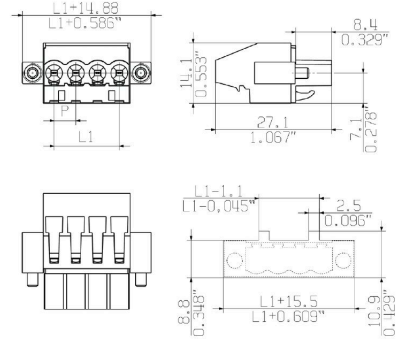

MIN. FRONT PLATE CUT-OUT

## BLZP 5.08HC/05/270F SN BK BX

**Weidmüller Interface GmbH & Co. KG**  
Klingenbergstraße 26  
D-32758 Detmold  
Germany

www.weidmueller.com

## Accessories

### Coding elements

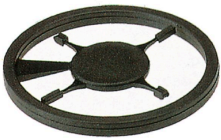

Only connects what is supposed to be connected: the right connection at the right place.  
Coding elements and locking devices clearly assign connecting elements during the manufacturing process and operation  
The coding elements and locking devices are inserted prior to assembly or during the cable assembly phase. The Weidmüller alternative: configure online using the variant configurator to precode prior to delivery. Incorrect assembly on the circuit board and incorrect plugging of connecting elements is no longer possible. The advantage: no troubleshooting during manufacture and no operational errors by the user.

### General ordering data

Type	BLZ/SL KO OR BX	Version
Order No.	<a href="#">1573010000</a>	PCB plug-in connector, Accessories, Coding element, orange, Number of poles: 1
GTIN (EAN)	4008190048396	
Qty.	100 ST	
Type	BLZ/SL KO BK BX	Version
Order No.	<a href="#">1545710000</a>	PCB plug-in connector, Accessories, Coding element, black, Number of poles: 1
GTIN (EAN)	4008190087142	
Qty.	50 ST	

### Slotted screwdriver

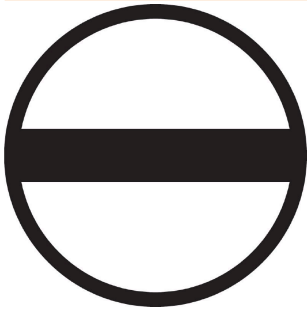

Slotted screwdriver with rounded blade SD DIN 5265, ISO 2380/2, output to DIN 5264, ISO 2380/1. ChromTop tip, SoftFinish grip

### General ordering data

Type	SDS 0.6X3.5X100	Version
Order No.	<a href="#">2749340000</a>	Screwdriver, Blade width (B): 3.5 mm, Blade length: 100 mm, Blade thickness (A): 0.6 mm
GTIN (EAN)	4050118895568	
Qty.	1 ST	
Type	SDIS 0.6X3.5X100	Version
Order No.	<a href="#">2749810000</a>	Screwdriver, Blade width (B): 3.5 mm, Blade length: 100 mm, Blade thickness (A): 0.6 mm
GTIN (EAN)	4050118897012	
Qty.	1 ST	



**BLZP 5.08HC/05/270F SN BK BX**

**Weidmüller Interface GmbH & Co. KG**  
Klingenbergstraße 26  
D-32758 Detmold  
Germany

www.weidmueller.com

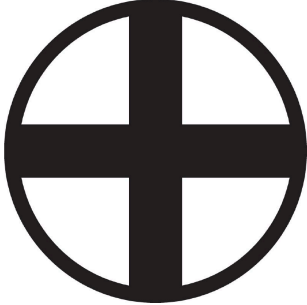
**Accessories****Crosshead screwdriver Phillips**

Crosshead screwdriver, Phillips, SDK PH DIN 5262, ISO 8764/2-PH, output to ISO 8764-PH, ChromTop tip, SoftFinish grip

**General ordering data**

Type	SDK PH1 X 80	Version	
Order No.	<a href="#">2749410000</a>	Screwdriver, Blade width (B): 1 mm, 80 mm, Blade thickness (A): 1	
GTIN (EAN)	4050118895636		
Qty.	1 ST		

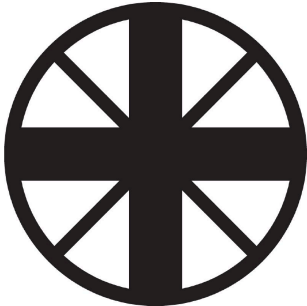
**Crosshead screwdriver Pozidriv**

Crosshead screwdriver, Pozidriv, SDK PZ DIN 5262, ISO 8764/2-PZ, output to ISO 8764/1-PZ, ChromTop tip, SoftFinish grip

**General ordering data**

Type	SDK PZ1 X 80	Version	
Order No.	<a href="#">2749440000</a>	Screwdriver, Blade width (B): 1 mm, 80 mm, Blade thickness (A): 1	
GTIN (EAN)	4050118895667		
Qty.	1 ST		

## BLZP 5.08HC/05/270F SN BK BX

**Weidmüller Interface GmbH & Co. KG**  
 Klingenbergstraße 26  
 D-32758 Detmold  
 Germany

## Counterpart

www.weidmueller.com

### SL 5.08HC/180F

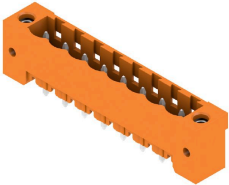

Pin headers in glass-fibre-reinforced plastic with straight wire outlet; optimised for wave soldering. The flange variant (F) can be screwed onto the respective counter piece or the circuit board. There is no need for an extra screw to connect the circuit board when the solder flange (LF) version is used. This also protects the solder points from mechanical strain. All pin headers can be manually coded or ordered pre-coded. HC = High Current.

#### General ordering data

Type	SL 5.08HC/05/180F 3.2SN...	Version
Order No.	<a href="#">1148570000</a>	PCB plug-in connector, male header, Flange, THT solder connection,
GTIN (EAN)	4032248932122	5.08 mm, Number of poles: 5, 180°, Solder pin length (l): 3.2 mm,
Qty.	48 ST	tinned, black, Box
Type	SL 5.08HC/05/180F 3.2SN...	Version
Order No.	<a href="#">1147230000</a>	PCB plug-in connector, male header, Flange, THT solder connection,
GTIN (EAN)	4032248931064	5.08 mm, Number of poles: 5, 180°, Solder pin length (l): 3.2 mm,
Qty.	48 ST	tinned, orange, Box

### SL 5.08HC/180LF

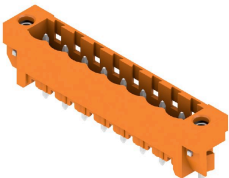

Pin headers in glass-fibre-reinforced plastic with straight wire outlet; optimised for wave soldering. The flange variant (F) can be screwed onto the respective counter piece or the circuit board. There is no need for an extra screw to connect the circuit board when the solder flange (LF) version is used. This also protects the solder points from mechanical strain. All pin headers can be manually coded or ordered pre-coded. HC = High Current.

#### General ordering data

Type	SL 5.08HC/05/180LF 3.2S...	Version
Order No.	<a href="#">1149320000</a>	PCB plug-in connector, male header, Solder flange, THT solder
GTIN (EAN)	4032248932610	connection, 5.08 mm, Number of poles: 5, 180°, Solder pin length (l):
Qty.	48 ST	3.2 mm, tinned, black, Box
Type	SL 5.08HC/05/180LF 3.2S...	Version
Order No.	<a href="#">1147990000</a>	PCB plug-in connector, male header, Solder flange, THT solder
GTIN (EAN)	4032248107988	connection, 5.08 mm, Number of poles: 5, 180°, Solder pin length (l):
Qty.	48 ST	3.2 mm, tinned, orange, Box

**BLZP 5.08HC/05/270F SN BK BX**

**Weidmüller Interface GmbH & Co. KG**  
 Klingenbergstraße 26  
 D-32758 Detmold  
 Germany

**Counterpart**

www.weidmueller.com

**SL 5.08HC/90F**

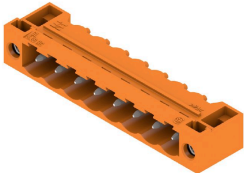

Pin headers made from glass-fibre-reinforced plastic with 90° wire outlet; optimised for wave soldering. The flange variant (F) can be screwed onto the respective counter piece or the circuit board. There is no need for an extra screw to connect the circuit board when the solder flange (LF) version is used. This also protects the solder points from mechanical strain. All pin headers can be manually coded or ordered pre-coded. HC = High Current.

**General ordering data**

Type	SL 5.08HC/05/90F 3.2SN ...	Version
Order No.	<a href="#">1150120000</a>	PCB plug-in connector, male header, Flange, THT solder connection,
GTIN (EAN)	4032248936724	5.08 mm, Number of poles: 5, 90°, Solder pin length (l): 3.2 mm,
Qty.	48 ST	tinned, black, Box
Type	SL 5.08HC/05/90F 3.2SN ...	Version
Order No.	<a href="#">1148710000</a>	PCB plug-in connector, male header, Flange, THT solder connection,
GTIN (EAN)	4032248935406	5.08 mm, Number of poles: 5, 90°, Solder pin length (l): 3.2 mm,
Qty.	48 ST	tinned, orange, Box

**SL 5.08HC/90LF**

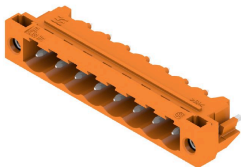

Pin headers made from glass-fibre-reinforced plastic with 90° wire outlet; optimised for wave soldering. The flange variant (F) can be screwed onto the respective counter piece or the circuit board. There is no need for an extra screw to connect the circuit board when the solder flange (LF) version is used. This also protects the solder points from mechanical strain. All pin headers can be manually coded or ordered pre-coded. HC = High Current.

**General ordering data**

Type	SL 5.08HC/05/90LF 3.2SN...	Version
Order No.	<a href="#">1150380000</a>	PCB plug-in connector, male header, Solder flange, THT solder
GTIN (EAN)	4032248936397	connection, 5.08 mm, Number of poles: 5, 90°, Solder pin length (l):
Qty.	48 ST	3.2 mm, tinned, black, Box
Type	SL 5.08HC/05/90LF 3.2SN...	Version
Order No.	<a href="#">1149480000</a>	PCB plug-in connector, male header, Solder flange, THT solder
GTIN (EAN)	4032248935970	connection, 5.08 mm, Number of poles: 5, 90°, Solder pin length (l):
Qty.	48 ST	3.2 mm, tinned, orange, Box

## BLZP 5.08HC/05/270F SN BK BX

Weidmüller Interface GmbH & Co. KG  
Klingenbergstraße 26  
D-32758 Detmold  
Germany

## Counterpart

www.weidmueller.com

## SL-SMT 5.08/180F Box



High-temperature-resistant pin header, packed in box or tape. On tape, with 1.5 mm solder pin, optimised for automatic assembly. 3.2 mm solder pin suitable for reflow and wave soldering. The pin headers provide space for labelling and can be coded. HC = High Current.

## General ordering data

Type	SL-SMT 5.08HC/05/180F 1...	Version
Order No.	<a href="#">1837330000</a>	PCB plug-in connector, male header, Flange, THT/THR solder connection, 5.08 mm, Number of poles: 5, 180°, Solder pin length (l):
GTIN (EAN)	4032248345922	
Qty.	48 ST	1.5 mm, tinned, black, Box
Type	SL-SMT 5.08HC/05/180F 3...	Version
Order No.	<a href="#">1820770000</a>	PCB plug-in connector, male header, Flange, THT/THR solder connection, 5.08 mm, Number of poles: 5, 180°, Solder pin length (l):
GTIN (EAN)	4032248317639	
Qty.	48 ST	3.2 mm, tinned, black, Box

## SL-SMT 5.08/180LF Box

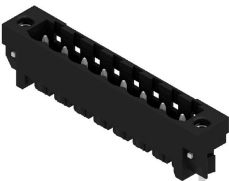

High-temperature-resistant pin header, packed in box or tape. On tape, with 1.5 mm solder pin, optimised for automatic assembly. 3.2 mm solder pin suitable for reflow and wave soldering. The pin headers provide space for labelling and can be coded. HC = High Current.

## General ordering data

Type	SL-SMT 5.08HC/05/180LF ...	Version
Order No.	<a href="#">1776392001</a>	PCB plug-in connector, male header, Solder flange, THT/THR solder connection, 5.08 mm, Number of poles: 5, 180°, Solder pin length (l):
GTIN (EAN)	4032248159178	
Qty.	48 ST	1.5 mm, tinned, black, Box
Type	SL-SMT 5.08HC/05/180LF ...	Version
Order No.	<a href="#">1838470000</a>	PCB plug-in connector, male header, Solder flange, THT/THR solder connection, 5.08 mm, Number of poles: 5, 180°, Solder pin length (l):
GTIN (EAN)	4032248348534	
Qty.	48 ST	3.2 mm, tinned, black, Box

## BLZP 5.08HC/05/270F SN BK BX

Weidmüller Interface GmbH & Co. KG  
Klingenbergstraße 26  
D-32758 Detmold  
Germany

www.weidmueller.com

## Counterpart

## SL-SMT 5.08/180LF Tape



High-temperature-resistant pin header, packed in box or tape. On tape, with 1.5 mm solder pin, optimised for automatic assembly. 3.2 mm solder pin suitable for reflow and wave soldering. The pin headers provide space for labelling and can be coded. HC = High Current.

## General ordering data

Type	SL-SMT 5.08HC/05/180LF ...	Version
Order No.	<a href="#">1776394001</a>	PCB plug-in connector, male header, Solder flange, THT/THR solder connection, 5.08 mm, Number of poles: 5, 180°, Solder pin length (l):
GTIN (EAN)	4032248163618	
Qty.	250 ST	1.5 mm, tinned, black, Tape

## SL-SMT 5.08/270FH Box

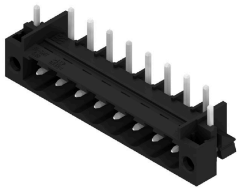

High-temperature-resistant, straight, open pin header. Packed in box or tape. On tape and with 1.5 mm solder pin, optimised for automatic assembly. 3.2 mm solder pin suitable for reflow and wave soldering. The pin headers provide space for labelling and can be coded. HC = High Current.

## General ordering data

Type	SL-SMT 5.08HC/05/270FH ...	Version
Order No.	<a href="#">1877990000</a>	PCB plug-in connector, male header, Solder flange, THT/THR solder connection, 5.08 mm, Number of poles: 5, 270°, Solder pin length (l):
GTIN (EAN)	4032248468744	
Qty.	50 ST	1.5 mm, tinned, black, Box
Type	SL-SMT 5.08HC/05/270FH ...	Version
Order No.	<a href="#">1877430000</a>	PCB plug-in connector, male header, Solder flange, THT/THR solder connection, 5.08 mm, Number of poles: 5, 270°, Solder pin length (l):
GTIN (EAN)	4032248468072	
Qty.	50 ST	3.2 mm, tinned, black, Box

## SL-SMT 5.08/270FH Tape



High-temperature-resistant, straight, open pin header. Packed in box or tape. On tape and with 1.5 mm solder pin, optimised for automatic assembly. 3.2 mm solder pin suitable for reflow and wave soldering. The pin headers provide space for labelling and can be coded. HC = High Current.

## BLZP 5.08HC/05/270F SN BK BX

**Weidmüller Interface GmbH & Co. KG**  
 Klingenbergstraße 26  
 D-32758 Detmold  
 Germany

www.weidmueller.com

## Counterpart

### General ordering data

Type	SL-SMT 5.08HC/05/270FH ...	Version
Order No.	<a href="#">1876950000</a>	PCB plug-in connector, male header, Solder flange, THT/THR solder
GTIN (EAN)	4032248467402	connection, 5.08 mm, Number of poles: 5, 270°, Solder pin length (l):
Qty.	335 ST	1.5 mm, tinned, black, Tape

### SL-SMT 5.08/270FL Box



High-temperature-resistant, straight, open pin header. Packed in box or tape. On tape and with 1.5 mm solder pin, optimised for automatic assembly. 3.2 mm solder pin suitable for reflow and wave soldering. The pin headers provide space for labelling and can be coded. HC = High Current.

### General ordering data

Type	SL-SMT 5.08HC/05/270FL ...	Version
Order No.	<a href="#">1876880000</a>	PCB plug-in connector, male header, Solder flange, THT/THR solder
GTIN (EAN)	4032248467464	connection, 5.08 mm, Number of poles: 5, 270°, Solder pin length (l):
Qty.	50 ST	3.2 mm, tinned, black, Box

### SL-SMT 5.08/270FL Tape



High-temperature-resistant, straight, open pin header. Packed in box or tape. On tape and with 1.5 mm solder pin, optimised for automatic assembly. 3.2 mm solder pin suitable for reflow and wave soldering. The pin headers provide space for labelling and can be coded. HC = High Current.

### General ordering data

Type	SL-SMT 5.08HC/05/270FL ...	Version
Order No.	<a href="#">1877070000</a>	PCB plug-in connector, male header, Solder flange, THT/THR solder
GTIN (EAN)	4032248467686	connection, 5.08 mm, Number of poles: 5, 270°, Solder pin length (l):
Qty.	350 ST	1.5 mm, tinned, black, Tape
Type	SL-SMT 5.08HC/05/270FL ...	Version
Order No.	<a href="#">1876700000</a>	PCB plug-in connector, male header, Solder flange, THT/THR solder
GTIN (EAN)	4032248467211	connection, 5.08 mm, Number of poles: 5, 270°, Solder pin length (l):
Qty.	350 ST	3.2 mm, tinned, black, Tape

**BLZP 5.08HC/05/270F SN BK BX**

**Weidmüller Interface GmbH & Co. KG**  
 Klingenbergstraße 26  
 D-32758 Detmold  
 Germany

www.weidmueller.com

**Counterpart****SL-SMT 5.08HC/90F Box**

High-temperature-resistant pin header, packed in box or tape. On tape, with 1.5 mm solder pin, optimised for automatic assembly. 3.2 mm solder pin suitable for reflow and wave soldering. The pin headers provide space for labelling and can be coded. HC = High Current.

**General ordering data**

Type	SL-SMT 5.08HC/05/90F 3...	Version
Order No.	<a href="#">1837660000</a>	PCB plug-in connector, male header, Flange, THT/THR solder connection, 5.08 mm, Number of poles: 5, 90°, Solder pin length (l):
GTIN (EAN)	4032248347476	3.2 mm, tinned, black, Box
Qty.	48 ST	

**SL-SMT 5.08HC/90LF Box**

High-temperature-resistant pin header, packed in box or tape. On tape, with 1.5 mm solder pin, optimised for automatic assembly. 3.2 mm solder pin suitable for reflow and wave soldering. The pin headers provide space for labelling and can be coded. HC = High Current.

**General ordering data**

Type	SL-SMT 5.08HC/05/90LF 1...	Version
Order No.	<a href="#">1775262001</a>	PCB plug-in connector, male header, Solder flange, THT/THR solder connection, 5.08 mm, Number of poles: 5, 90°, Solder pin length (l):
GTIN (EAN)	4032248157242	1.5 mm, tinned, black, Box
Qty.	48 ST	
Type	SL-SMT 5.08HC/05/90LF 3...	Version
Order No.	<a href="#">1780440000</a>	PCB plug-in connector, male header, Solder flange, THT/THR solder connection, 5.08 mm, Number of poles: 5, 90°, Solder pin length (l):
GTIN (EAN)	4032248165766	3.2 mm, tinned, black, Box
Qty.	48 ST	

**SL-SMT 5.08HC/90LF Tape**

High-temperature-resistant pin header, packed in box or tape. On tape, with 1.5 mm solder pin, optimised for automatic assembly. 3.2 mm solder pin suitable for reflow and wave soldering. The pin headers provide space for labelling and can be coded. HC = High Current.

**BLZP 5.08HC/05/270F SN BK BX**

**Weidmüller Interface GmbH & Co. KG**  
 Klingenbergstraße 26  
 D-32758 Detmold  
 Germany

www.weidmueller.com

**Counterpart****General ordering data**

Type	SL-SMT 5.08HC/05/90LF 1...	Version
Order No.	<a href="#">1775264001</a>	PCB plug-in connector, male header, Solder flange, THT/THR solder
GTIN (EAN)	4032248167814	connection, 5.08 mm, Number of poles: 5, 90°, Solder pin length (l):
Qty.	350 ST	1.5 mm, tinned, black, Tape

**SLDV-THR 5.08/180F**

High-temperature resistant, double level, laterally offset, male connector with flange or solder flange. 1.5 mm solder pin is suitable for reflow soldering. 3.2 mm solder pin suitable for reflow and wave soldering. The pin headers provide space for labelling and can be coded.

**General ordering data**

Type	SLDV-THR 5.08/10/180F 1...	Version
Order No.	<a href="#">1828920000</a>	PCB plug-in connector, male header, Flange, THT/THR solder
GTIN (EAN)	4032248335619	connection, 5.08 mm, Number of poles: 10, 180°, Solder pin length
Qty.	32 ST	(l): 1.5 mm, tinned, black, Box
Type	SLDV-THR 5.08/10/180F 3...	Version
Order No.	<a href="#">1828800000</a>	PCB plug-in connector, male header, Flange, THT/THR solder
GTIN (EAN)	4032248335480	connection, 5.08 mm, Number of poles: 10, 180°, Solder pin length
Qty.	32 ST	(l): 3.2 mm, tinned, black, Box

**SLDV-THR 5.08/180FLF**

High-temperature resistant, double level, laterally offset, male connector with flange or solder flange. 1.5 mm solder pin is suitable for reflow soldering. 3.2 mm solder pin suitable for reflow and wave soldering. The pin headers provide space for labelling and can be coded.

**General ordering data**

Type	SLDV-THR 5.08/10/180FLF...	Version
Order No.	<a href="#">1829040000</a>	PCB plug-in connector, male header, Flange / Solder flange, THT/THR
GTIN (EAN)	4032248335732	solder connection, 5.08 mm, Number of poles: 10, 180°, Solder pin
Qty.	32 ST	length (l): 3.2 mm, tinned, black, Box



## BLZP 5.08HC/05/270F SN BK BX

**Weidmüller Interface GmbH & Co. KG**  
 Klingenbergstraße 26  
 D-32758 Detmold  
 Germany

## Counterpart

www.weidmueller.com

## SLF 5.08/180F SN

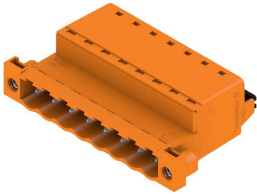

Male plug with PUSH IN wire connection and straight outlet direction, when used with BLF 5.08HC as wire-to-wire application for panel feed-through The male plugs provide space for labelling and can be coded.

## General ordering data

Type	SLF 5.08/05/180F SN BK ...	Version
Order No.	<a href="#">1336200000</a>	PCB plug-in connector, male plug, 5.08 mm, Number of poles: 5,
GTIN (EAN)	4050118139945	180°, PUSH IN with actuator, Clamping range, max. : 3.31 mm <sup>2</sup> , Box
Qty.	54 ST	
Type	SLF 5.08/05/180F SN OR ...	Version
Order No.	<a href="#">1335660000</a>	PCB plug-in connector, male plug, 5.08 mm, Number of poles: 5,
GTIN (EAN)	4050118139648	180°, PUSH IN with actuator, Clamping range, max. : 3.31 mm <sup>2</sup> , Box
Qty.	54 ST	

## SLF 5.08/180FI SN

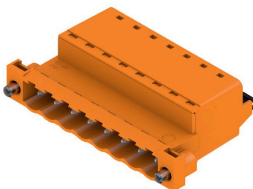

Male plug with PUSH IN wire connection and straight outlet direction, when used with BLF 5.08HC as wire-to-wire application for panel feed-through The male plugs provide space for labelling and can be coded.

## General ordering data

Type	SLF 5.08/05/180FI SN BK...	Version
Order No.	<a href="#">1336080000</a>	PCB plug-in connector, male plug, 5.08 mm, Number of poles: 5,
GTIN (EAN)	4050118139884	180°, PUSH IN with actuator, Clamping range, max. : 3.31 mm <sup>2</sup> , Box
Qty.	54 ST	
Type	SLF 5.08/05/180FI SN OR...	Version
Order No.	<a href="#">1336430000</a>	PCB plug-in connector, male plug, 5.08 mm, Number of poles: 5,
GTIN (EAN)	4050118140729	180°, PUSH IN with actuator, Clamping range, max. : 3.31 mm <sup>2</sup> , Box
Qty.	54 ST	

## BLZP 5.08HC/05/270F SN BK BX

**Weidmüller Interface GmbH & Co. KG**  
 Klingenbergstraße 26  
 D-32758 Detmold  
 Germany

[www.weidmueller.com](http://www.weidmueller.com)

## Counterpart

### SLS 5.08/180F

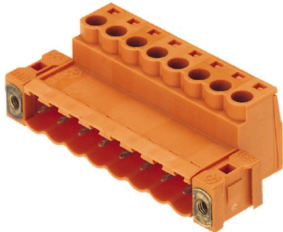

Male plugs with clamping-yoke screw wire-connect system. The male plugs provide space for labelling and can be coded.

#### General ordering data

Type	SLS 5.08/05/180F SN OR ...	Version
Order No.	<a href="#">1846390000</a>	PCB plug-in connector, male plug, 5.08 mm, Number of poles: 5,
GTIN (EAN)	4032248362097	180°, Clamping yoke connection, Clamping range, max. : 3.31 mm²,
Qty.	48 ST	Box

### SLS 5.08/180FI

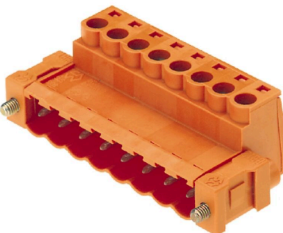

Male plugs with clamping-yoke screw wire-connect system. The male plugs provide space for labelling and can be coded.

#### General ordering data

Type	SLS 5.08/05/180FI SN OR...	Version
Order No.	<a href="#">1846240000</a>	PCB plug-in connector, male plug, 5.08 mm, Number of poles: 5,
GTIN (EAN)	4032248362523	180°, Clamping yoke connection, Clamping range, max. : 3.31 mm²,
Qty.	48 ST	Box