

BLZP 5.08HC/14/90 SN BK BX

Weidmüller Interface GmbH & Co. KG
 Klingenbergstraße 26
 D-32758 Detmold
 Germany

www.weidmueller.com

Product image

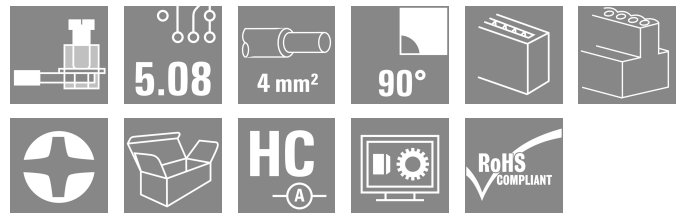

Female plugs with clamping-yoke connection for connecting wires with a right-angle (90° or 270°) outlet direction. The female connectors provide space for labelling and can be coded. Fastened by means of a flange or release latch. They also provide an integrated plus/minus screw, protection against faulty insertion of the wire, and they are delivered with open clamping yokes. HC = High Current.

General ordering data

Version	PCB plug-in connector, female plug, 5.08 mm, Number of poles: 14, 90°, Clamping yoke connection, Clamping range, max. : 4 mm², Box
Order No.	1948360000
Type	BLZP 5.08HC/14/90 SN BK BX
GTIN (EAN)	403224862488 1
Qty.	24 items
Product data	IEC: 400 V / 23 A / 0.2 - 4 mm² UL: 300 V / 20 A / AWG 26 - AWG 12
Packaging	Box

BLZP 5.08HC/14/90 SN BK BX

Weidmüller Interface GmbH & Co. KG
 Klingenbergstraße 26
 D-32758 Detmold
 Germany

www.weidmueller.com

Technical data

Approvals

Approvals



ROHS	Conform
UL File Number Search	UL Website
Certificate No. (cURus)	E60693

Dimensions and weights

Depth	27.2 mm	Depth (inches)	1.0709 inch
Height	14.1 mm	Height (inches)	0.5551 inch
Width	71.12 mm	Width (inches)	2.8 inch
Net weight	24.64 g		

Environmental Product Compliance

RoHS Compliance Status	Compliant without exemption
REACH SVHC	No SVHC above 0.1 wt%

System Parameters

Product family	OMNIMATE Signal - series BL/SL 5.08		
Type of connection	Field connection		
Wire connection method	Clamping yoke connection		
Pitch in mm (P)	5.08 mm		
Pitch in inches (P)	0.200 "		
Conductor outlet direction	90°		
Number of poles	14		
L1 in mm	66.04 mm		
L1 in inches	2.600 "		
Number of rows	1		
Pin series quantity	1		
Rated cross-section	4 mm ²		
Touch-safe protection acc. to DIN VDE 57 106	Safe from finger touch		
Touch-safe protection acc. to DIN VDE 0470	IP20 plugged/ IP10 unplugged		
Protection degree	IP20		
Volume resistance	≤5 mΩ		
Can be coded	Yes		
Stripping length	7 mm		
Clamping screw	M 2.5		
Screwdriver blade	0.6 x 3.5, PH 1, PZ 1		
Screwdriver blade standard	DIN 5264, ISO 8764/2-PH, ISO 8764/2-PZ		
Plugging cycles	25		
Plugging force/pole, max.	10 N		
Pulling force/pole, max.	9 N		
Tightening torque	Torque type	Wire connection	
	Usage information	Tightening torque	min. 0.4 Nm max. 0.5 Nm

BLZP 5.08HC/14/90 SN BK BX

Weidmüller Interface GmbH & Co. KG
 Klingenbergstraße 26
 D-32758 Detmold
 Germany

www.weidmueller.com

Technical data

Material data

Insulating material	PBT	Colour	black
Colour chart (similar)	RAL 9011	Insulating material group	Illa
Comparative Tracking Index (CTI)	≥ 200	Moisture Level (MSL)	
UL 94 flammability rating	V-0	Contact material	Cu-alloy
Contact surface	tinned	Layer structure of plug contact	4...8 µm Sn hot-dip tinned
Storage temperature, min.	-40 °C	Storage temperature, max.	70 °C
Operating temperature, min.	-50 °C	Operating temperature, max.	100 °C
Temperature range, installation, min.	-25 °C	Temperature range, installation, max.	100 °C

Conductors suitable for connection

Clamping range, min.	0.13 mm ²
Clamping range, max.	4 mm ²
Wire connection cross section AWG, min.	AWG 30
Wire connection cross section AWG, max.	AWG 12
Solid, min. H05(07) V-U	0.2 mm ²
Solid, max. H05(07) V-U	4 mm ²
Flexible, min. H05(07) V-K	0.2 mm ²
Flexible, max. H05(07) V-K	4 mm ²
w. plastic collar ferrule, DIN 46228 pt 4, min.	0.2 mm ²
w. plastic collar ferrule, DIN 46228 pt 4, max.	2.5 mm ²
w. wire end ferrule, DIN 46228 pt 1, min.	0.2 mm ²
w. wire end ferrule, DIN 46228 pt 1, max.	4 mm ²
Plug gauge in accordance with EN 60999 a x b; ø	2.8 mm x 2.4 mm

Clampable conductor	Cross-section for conductor connection wire end ferrule	nominal	0.5 mm ²
		Stripping length	nominal 6 mm
		Recommended wire-end ferrule	H0,5/6
		Stripping length	nominal 8 mm
	Cross-section for conductor connection wire end ferrule	nominal	1 mm ²
		Stripping length	nominal 6 mm
		Recommended wire-end ferrule	H1,0/6
		Stripping length	nominal 8 mm
	Cross-section for conductor connection wire end ferrule	nominal	1.5 mm ²
		Stripping length	nominal 7 mm
		Recommended wire-end ferrule	H1,5/7
		Stripping length	nominal 10 mm
Cross-section for conductor connection wire end ferrule	nominal	2.5 mm ²	
	Stripping length	nominal 7 mm	
	Recommended wire-end ferrule	H2,5/7	
	Stripping length	nominal 10 mm	
Cross-section for conductor connection wire end ferrule	nominal	2.5 mm ²	
	Stripping length	nominal 7 mm	
	Recommended wire-end ferrule	H2,5/7	
	Stripping length	nominal 10 mm	
Cross-section for conductor connection wire end ferrule	nominal	2.5 mm ²	
	Stripping length	nominal 7 mm	
	Recommended wire-end ferrule	H2,5/7	
	Stripping length	nominal 10 mm	

Reference text The outside diameter of the plastic collar should not be larger than the pitch (P). Length of ferrules is to be chosen depending on the product and the rated voltage.

BLZP 5.08HC/14/90 SN BK BX

Weidmüller Interface GmbH & Co. KG
 Klingenbergstraße 26
 D-32758 Detmold
 Germany

www.weidmueller.com

Technical data

Rated data acc. to IEC

tested acc. to standard	IEC 60664-1, IEC 61984	Rated current, min. number of poles (Tu=20°C)	23 A
Rated current, max. number of poles (Tu=20°C)	18 A	Rated current, min. number of poles (Tu=40°C)	21 A
Rated current, max. number of poles (Tu=40°C)	16 A	Rated voltage for surge voltage class / pollution degree II/2	400 V
Rated voltage for surge voltage class / pollution degree III/2	320 V	Rated voltage for surge voltage class / pollution degree III/3	250 V
Rated impulse voltage for surge voltage class/ pollution degree II/2	4 kV	Rated impulse voltage for surge voltage class/ pollution degree III/2	4 kV
Rated impulse voltage for surge voltage class/ contamination degree III/3	4 kV	Short-time withstand current resistance	3 x 1s with 120 A

Rated data acc. to CSA

Institute (CSA)	CSA	Certificate No. (CSA)	200039-1121690
Rated voltage (Use group B / CSA)	300 V	Rated voltage (Use group C / CSA)	50 V
Rated voltage (Use group D / CSA)	300 V	Rated current (Use group B / CSA)	20 A
Rated current (Use group D / CSA)	20 A	Wire cross-section, AWG, min.	AWG 30
Wire cross-section, AWG, max.	AWG 12	Reference to approval values	Specifications are maximum values, details - see approval certificate.

Rated data acc. to UL 1059

Institute (cURus)	CURUS	Certificate No. (cURus)	E60693
Rated voltage (Use group B / UL 1059)	300 V	Rated voltage (Use group D / UL 1059)	300 V
Rated current (Use group B / UL 1059)	20 A	Rated current (Use group D / UL 1059)	10 A
Wire cross-section, AWG, min.	AWG 26	Wire cross-section, AWG, max.	AWG 12
Reference to approval values	Specifications are maximum values, details - see approval certificate.		

Packing

Packaging	Box	VPE length	350.00 mm
VPE width	138.00 mm	VPE height	34.00 mm

Type tests

Test: Durability of markings	Standard	DIN EN 61984 section 7.3.2 / 09.02 taking pattern from DIN EN 60068-2-70 / 07.96
	Test	mark of origin, rated voltage, rated cross-section, type of material
	Evaluation	available
	Test	durability
Test: Misengagement (Non-interchangeability)	Standard	DIN EN 60512-13-5 / 11.06, IEC 60512-13-5 / 02.06
	Test	180° turned with coding elements
	Evaluation	passed
	Test	visual examination
Test: Clampable cross section	Evaluation	passed
	Standard	DIN EN 60999-1 section 7 and 9.1 / 12.00, DIN EN 60947-1 section 8.2.4.5.1 / 12.02
	Conductor type	Type of conductor solid 0.2 mm ² and conductor cross-section

BLZP 5.08HC/14/90 SN BK BX

Weidmüller Interface GmbH & Co. KG
 Klingenbergstraße 26
 D-32758 Detmold
 Germany

www.weidmueller.com

Technical data

		Type of conductor and conductor cross-section	stranded 0.2 mm ²	
		Type of conductor and conductor cross-section	solid 2.5 mm ²	
		Type of conductor and conductor cross-section	stranded 2.5 mm ²	
		Type of conductor and conductor cross-section	AWG 26/1	
		Type of conductor and conductor cross-section	AWG 26/19	
	Evaluation	passed		
Test for damage to and accidental loosening of conductors	Standard	DIN EN 60999-1 section 9.4 / 12.00		
	Requirement	0.2 kg		
	Conductor type	Type of conductor and conductor cross-section	AWG 26/1	
		Type of conductor and conductor cross-section	AWG 26/19	
	Evaluation	passed		
	Requirement	0.3 kg		
	Conductor type	Type of conductor and conductor cross-section	solid 0.5 mm ²	
		Type of conductor and conductor cross-section	stranded 0.5 mm ²	
	Evaluation	passed		
	Requirement	0.9 kg		
Pull-out test	Conductor type	Type of conductor and conductor cross-section	AWG 12/1	
		Type of conductor and conductor cross-section	AWG 12/19	
	Evaluation	passed		
	Standard	DIN EN 60999-1 section 9.5 / 12.00		
	Requirement	≥10 N		
	Conductor type	Type of conductor and conductor cross-section	AWG 26/1	
		Type of conductor and conductor cross-section	AWG 26/19	
	Evaluation	passed		
	Requirement	≥20 N		
	Conductor type	Type of conductor and conductor cross-section	H05V-U0.5	
Type of conductor and conductor cross-section		H05V-K0.5		
Evaluation	passed			
Requirement	≥60 N			
Conductor type	Type of conductor and conductor cross-section	H07V-U4.0		

BLZP 5.08HC/14/90 SN BK BX

Weidmüller Interface GmbH & Co. KG
 Klingenbergstraße 26
 D-32758 Detmold
 Germany

www.weidmueller.com

Technical data

	Type of conductor and conductor cross-section	H07V-K4.0
	Type of conductor and conductor cross-section	AWG 12/1
	Type of conductor and conductor cross-section	AWG 12/19
Evaluation	passed	

Important note

IPC conformity	Conformity: The products are developed, manufactured and delivered according international recognized standards and norms and comply with the assured properties in the data sheet resp. fulfill decorative properties in accordance with IPC-A-610 "Class 2". Further claims on the products can be evaluated on request.
Notes	<ul style="list-style-type: none"> • Additional variants on request • Gold-plated contact surfaces on request • Rated current related to rated cross-section & min. No. of poles. • Wire end ferrule without plastic collar to DIN 46228/1 • Wire end ferrule with plastic collar to DIN 46228/4 • P on drawing = pitch • Rated data refer only to the component itself. Clearance and creepage distances to other components are to be designed in accordance with the relevant application standards. • In accordance with IEC 61984, OMNIMATE-connectors are connectors without breaking capacity (COC). During designated use, connectors are not allowed to be engaged or disengaged when live or under load • Long term storage of the product with average temperature of 50 °C and maximum humidity 70%, 36 months

Classifications

ETIM 8.0	EC002638	ETIM 9.0	EC002638
ETIM 10.0	EC002638	ECLASS 14.0	27-46-02-02
ECLASS 15.0	27-46-02-02		

BLZP 5.08HC/14/90 SN BK BX

Weidmüller Interface GmbH & Co. KG
Klingenbergstraße 26
D-32758 Detmold
Germany

www.weidmueller.com

Drawings

Product image



Dimensional drawing

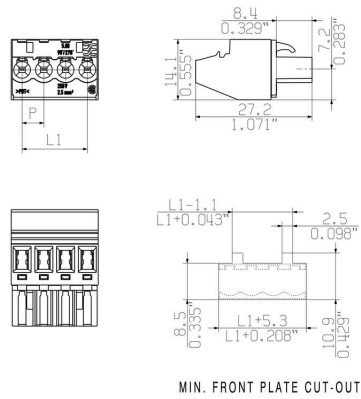

BLZP 5.08HC/14/90 SN BK BX

Weidmüller Interface GmbH & Co. KG
 Klingenbergstraße 26
 D-32758 Detmold
 Germany

www.weidmueller.com

Accessories

Coding elements



Only connects what is supposed to be connected: the right connection at the right place.

Coding elements and locking devices clearly assign connecting elements during the manufacturing process and operation

The coding elements and locking devices are inserted prior to assembly or during the cable assembly phase. The Weidmüller alternative: configure online using the variant configurator to precode prior to delivery. Incorrect assembly on the circuit board and incorrect plugging of connecting elements is no longer possible. The advantage: no troubleshooting during manufacture and no operational errors by the user.

General ordering data

Type	BLZ/SL KO OR BX	Version
Order No.	1573010000	PCB plug-in connector, Accessories, Coding element, orange, Number
GTIN (EAN)	4008190048396	of poles: 1
Qty.	100 ST	
Type	BLZ/SL KO BK BX	Version
Order No.	1545710000	PCB plug-in connector, Accessories, Coding element, black, Number
GTIN (EAN)	4008190087142	of poles: 1
Qty.	50 ST	

Slotted screwdriver

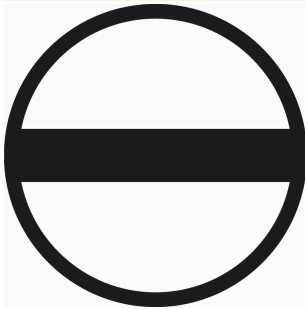

Slotted screwdriver with rounded blade SD DIN 5265, ISO 2380/2, output to DIN 5264, ISO 2380/1. ChromTop tip, SoftFinish grip

General ordering data

Type	SDS 0.6X3.5X100	Version
Order No.	2749340000	Screwdriver, Blade width (B): 3.5 mm, Blade length: 100 mm, Blade thickness (A): 0.6 mm
GTIN (EAN)	4050118895568	
Qty.	1 ST	
Type	SDIS 0.6X3.5X100	Version
Order No.	2749810000	Screwdriver, Blade width (B): 3.5 mm, Blade length: 100 mm, Blade thickness (A): 0.6 mm
GTIN (EAN)	4050118897012	
Qty.	1 ST	

BLZP 5.08HC/14/90 SN BK BX

Weidmüller Interface GmbH & Co. KG
 Klingenbergstraße 26
 D-32758 Detmold
 Germany

www.weidmueller.com

Accessories

Crosshead screwdriver Phillips



Crosshead screwdriver, Phillips, SDK PH DIN 5262, ISO 8764/2-PH, output to ISO 8764-PH, ChromTop tip, SoftFinish grip

General ordering data

Type	SDK PH1 X 80	Version	
Order No.	2749410000	Screwdriver, Blade width (B): 4.5 mm, 80 mm, Blade thickness (A): 1	
GTIN (EAN)	4050118895636		
Qty.	1 ST		

Crosshead screwdriver Pozidriv



Crosshead screwdriver, Pozidriv, SDK PZ DIN 5262, ISO 8764/2-PZ, output to ISO 8764/1-PZ, ChromTop tip, SoftFinish grip

General ordering data

Type	SDK PZ1 X 80	Version	
Order No.	2749440000	Screwdriver, Blade width (B): 14.5 mm, 80 mm, Blade thickness (A): 1	
GTIN (EAN)	4050118895667		
Qty.	1 ST		

BLZP 5.08HC/14/90 SN BK BX

Weidmüller Interface GmbH & Co. KG
 Klingenbergstraße 26
 D-32758 Detmold
 Germany

www.weidmueller.com

Counterpart

SLDF 5.08

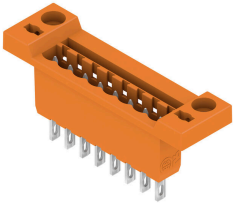

Male connector for through-panel mounting with optional locking function. Internal connection as flat-blade or solder connection. These male connectors provide space for labelling and can be coded.

General ordering data

Type	SLDF 5.08 L/F 14 SN OR ...	Version
Order No.	1599250000	PCB plug-in connector, male header, 5.08 mm, Number of poles: 14,
GTIN (EAN)	4008190178444	180°, Flat-blade connection, Solder connection, Box
Qty.	18 ST	

SL 5.08/135



Male connectors with 135° outlet direction. The solder pin length is optimised for wave flow soldering. The pin headers provide space for labelling and can be coded.

General ordering data

Type	SL 5.08/14/135 3.2SN OR...	Version
Order No.	1603180000	PCB plug-in connector, male header, open side, THT solder
GTIN (EAN)	4008190005702	connection, 5.08 mm, Number of poles: 14, 135°, Solder pin length
Qty.	50 ST	(l): 3.2 mm, tinned, orange, Box

SL 5.08/135B

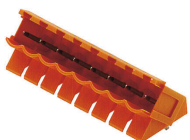

Male connectors with 135° outlet direction. The solder pin length is optimised for wave flow soldering. The pin headers provide space for labelling and can be coded.

General ordering data

Type	SL 5.08/14/135B 3.2SN O...	Version
Order No.	1605650000	PCB plug-in connector, male header, Dovetails for fixing blocks, THT
GTIN (EAN)	4008190048150	solder connection, 5.08 mm, Number of poles: 14, 135°, Solder pin
Qty.	50 ST	length (l): 3.2 mm, tinned, orange, Box

BLZP 5.08HC/14/90 SN BK BX

Weidmüller Interface GmbH & Co. KG
 Klingenbergstraße 26
 D-32758 Detmold
 Germany

www.weidmueller.com

Counterpart

SL 5.08/180

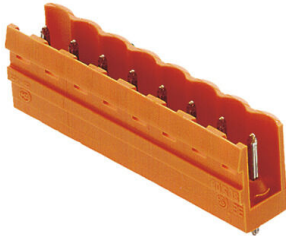

Male connectors with straight outlet direction. The solder pin length is optimised for wave flow soldering. The pin headers provide space for labelling and can be coded.

General ordering data

Type	SL 5.08/14/180 3.2SN OR...	Version
Order No.	1518460000	PCB plug-in connector, male header, open side, THT solder connection, 5.08 mm, Number of poles: 14, 180°, Solder pin length (l): 3.2 mm, tinned, orange, Box
GTIN (EAN)	4008190110109	
Qty.	50 ST	
Type	SL 5.08/14/180 4.5SN OR...	Version
Order No.	1523060000	PCB plug-in connector, male header, open side, THT solder connection, 5.08 mm, Number of poles: 14, 180°, Solder pin length (l): 4.5 mm, tinned, orange, Box
GTIN (EAN)	4008190188153	
Qty.	50 ST	

SL 5.08/180B



Male connectors with straight outlet direction. The solder pin length is optimised for wave flow soldering. The pin headers provide space for labelling and can be coded.

General ordering data

Type	SL 5.08/14/180B 3.2SN O...	Version
Order No.	1520760000	PCB plug-in connector, male header, Dovetails for fixing blocks, THT solder connection, 5.08 mm, Number of poles: 14, 180°, Solder pin length (l): 3.2 mm, tinned, orange, Box
GTIN (EAN)	4008190017125	
Qty.	50 ST	

SL 5.08/90

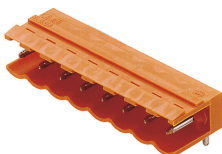

Male connectors with 90° outlet direction. The solder pin length is optimised for wave flow soldering. The pin headers provide space for labelling and can be coded.

BLZP 5.08HC/14/90 SN BK BX

Weidmüller Interface GmbH & Co. KG
 Klingenbergstraße 26
 D-32758 Detmold
 Germany

Counterpart

www.weidmueller.com

General ordering data

Type	SL 5.08/14/90 3.2SN OR ...	Version
Order No.	1509260000	PCB plug-in connector, male header, open side, THT solder
GTIN (EAN)	4008190158989	connection, 5.08 mm, Number of poles: 14, 90°, Solder pin length (l):
Qty.	50 ST	3.2 mm, tinned, orange, Box

SL 5.08/90B

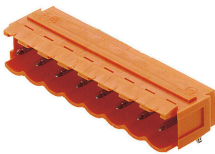

Male connectors with 90° outlet direction. The solder pin length is optimised for wave flow soldering. The pin headers provide space for labelling and can be coded.

General ordering data

Type	SL 5.08/14/90B 3.2SN OR...	Version
Order No.	1511560000	PCB plug-in connector, male header, Dovetails for fixing blocks, THT
GTIN (EAN)	4008190068479	solder connection, 5.08 mm, Number of poles: 14, 90°, Solder pin
Qty.	50 ST	length (l): 3.2 mm, tinned, orange, Box

SL 5.08HC/180

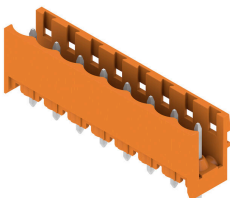

Pin headers in glass-fibre-reinforced plastic with straight wire outlet; optimised for wave soldering. The flange variant (F) can be screwed onto the respective counter piece or the circuit board. There is no need for an extra screw to connect the circuit board when the solder flange (LF) version is used. This also protects the solder points from mechanical strain. All pin headers can be manually coded or ordered pre-coded. HC = High Current.

General ordering data

Type	SL 5.08HC/14/180 3.2SN ...	Version
Order No.	1148370000	PCB plug-in connector, male header, open side, THT solder
GTIN (EAN)	4032248933761	connection, 5.08 mm, Number of poles: 14, 180°, Solder pin length
Qty.	50 ST	(l): 3.2 mm, tinned, black, Box
Type	SL 5.08HC/14/180 3.2SN ...	Version
Order No.	1146590000	PCB plug-in connector, male header, open side, THT solder
GTIN (EAN)	4032248933426	connection, 5.08 mm, Number of poles: 14, 180°, Solder pin length
Qty.	50 ST	(l): 3.2 mm, tinned, orange, Box

BLZP 5.08HC/14/90 SN BK BX

Weidmüller Interface GmbH & Co. KG
 Klingenbergstraße 26
 D-32758 Detmold
 Germany

Counterpart

www.weidmueller.com

SL 5.08HC/180B

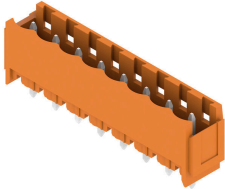

Pin headers in glass-fibre-reinforced plastic with straight wire outlet; optimised for wave soldering. The flange variant (F) can be screwed onto the respective counter piece or the circuit board. There is no need for an extra screw to connect the circuit board when the solder flange (LF) version is used. This also protects the solder points from mechanical strain. All pin headers can be manually coded or ordered pre-coded. HC = High Current.

General ordering data

Type	SL 5.08HC/14/180B 3.2SN...	Version
Order No.	1149800000	PCB plug-in connector, male header, Dovetails for fixing blocks, THT
GTIN (EAN)	4032248935260	solder connection, 5.08 mm, Number of poles: 14, 180°, Solder pin
Qty.	50 ST	length (l): 3.2 mm, tinned, black, Box
Type	SL 5.08HC/14/180B 3.2SN...	Version
Order No.	1147710000	PCB plug-in connector, male header, Dovetails for fixing blocks, THT
GTIN (EAN)	4032248934300	solder connection, 5.08 mm, Number of poles: 14, 180°, Solder pin
Qty.	50 ST	length (l): 3.2 mm, tinned, orange, Box

SL 5.08HC/180G

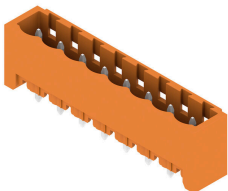

Pin headers in glass-fibre-reinforced plastic with straight wire outlet; optimised for wave soldering. The flange variant (F) can be screwed onto the respective counter piece or the circuit board. There is no need for an extra screw to connect the circuit board when the solder flange (LF) version is used. This also protects the solder points from mechanical strain. All pin headers can be manually coded or ordered pre-coded. HC = High Current.

General ordering data

Type	SL 5.08HC/14/180G 3.2SN...	Version
Order No.	1149030000	PCB plug-in connector, male header, closed side, THT solder
GTIN (EAN)	4032248934003	connection, 5.08 mm, Number of poles: 14, 180°, Solder pin length
Qty.	50 ST	(l): 3.2 mm, tinned, black, Box
Type	SL 5.08HC/14/180G 3.2SN...	Version
Order No.	1147000000	PCB plug-in connector, male header, closed side, THT solder
GTIN (EAN)	4032248934348	connection, 5.08 mm, Number of poles: 14, 180°, Solder pin length
Qty.	50 ST	(l): 3.2 mm, tinned, orange, Box

BLZP 5.08HC/14/90 SN BK BX

Weidmüller Interface GmbH & Co. KG
Klingenbergstraße 26
D-32758 Detmold
Germany

Counterpart

www.weidmueller.com

SL 5.08HC/90

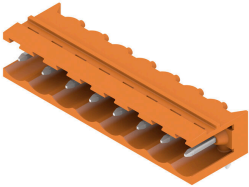

Pin headers made from glass-fibre-reinforced plastic with 90° wire outlet; optimised for wave soldering. The flange variant (F) can be screwed onto the respective counter piece or the circuit board. There is no need for an extra screw to connect the circuit board when the solder flange (LF) version is used. This also protects the solder points from mechanical strain. All pin headers can be manually coded or ordered pre-coded. HC = High Current.

General ordering data

Type	SL 5.08HC/14/90 3.2SN B...	Version
Order No.	1155180000	PCB plug-in connector, male header, open side, THT solder
GTIN (EAN)	4050118050691	connection, 5.08 mm, Number of poles: 14, 90°, Solder pin length (l):
Qty.	50 ST	3.2 mm, tinned, black, Box
Type	SL 5.08HC/14/90 3.2SN O...	Version
Order No.	1146990000	PCB plug-in connector, male header, open side, THT solder
GTIN (EAN)	4050118051384	connection, 5.08 mm, Number of poles: 14, 90°, Solder pin length (l):
Qty.	50 ST	3.2 mm, tinned, orange, Box

SL 5.08HC/90B

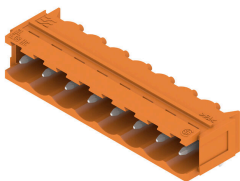

Pin headers made from glass-fibre-reinforced plastic with 90° wire outlet; optimised for wave soldering. The flange variant (F) can be screwed onto the respective counter piece or the circuit board. There is no need for an extra screw to connect the circuit board when the solder flange (LF) version is used. This also protects the solder points from mechanical strain. All pin headers can be manually coded or ordered pre-coded. HC = High Current.

General ordering data

Type	SL 5.08HC/14/90B 3.2SN ...	Version
Order No.	1155710000	PCB plug-in connector, male header, Dovetails for fixing blocks, THT
GTIN (EAN)	4050118050233	solder connection, 5.08 mm, Number of poles: 14, 90°, Solder pin
Qty.	50 ST	length (l): 3.2 mm, tinned, black, Box
Type	SL 5.08HC/14/90B 3.2SN ...	Version
Order No.	1154900000	PCB plug-in connector, male header, Dovetails for fixing blocks, THT
GTIN (EAN)	4050118050929	solder connection, 5.08 mm, Number of poles: 14, 90°, Solder pin
Qty.	50 ST	length (l): 3.2 mm, tinned, orange, Box

BLZP 5.08HC/14/90 SN BK BX

Weidmüller Interface GmbH & Co. KG
 Klingenbergstraße 26
 D-32758 Detmold
 Germany

www.weidmueller.com

Counterpart

SLDV 5.08/180

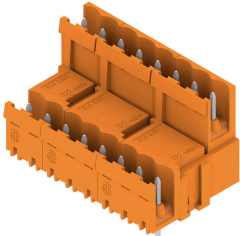

Pin headers with solder pin length optimised for wave flow soldering. The male connectors provide space for labelling and can be coded. HC = High Current.

General ordering data

Type	SLD 5.08V/28/180 3.2SN ...	Version
Order No.	1725770000	PCB plug-in connector, male header, open side, THT solder
GTIN (EAN)	4032248062065	connection, 5.08 mm, Number of poles: 28, 180°, Solder pin length
Qty.	10 ST	(l): 3.2 mm, tinned, orange, Box

SLDV 5.08/180B

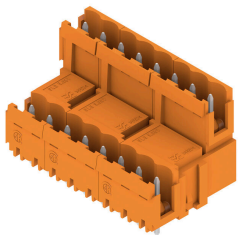

Pin headers with solder pin length optimised for wave flow soldering. The male connectors provide space for labelling and can be coded. HC = High Current.

General ordering data

Type	SLD 5.08V/28/180B 3.2SN...	Version
Order No.	1726860000	PCB plug-in connector, male header, Dovetails for fixing blocks, THT
GTIN (EAN)	4032248062744	solder connection, 5.08 mm, Number of poles: 28, 180°, Solder pin
Qty.	10 ST	length (l): 3.2 mm, tinned, orange, Box

SLDV 5.08/90

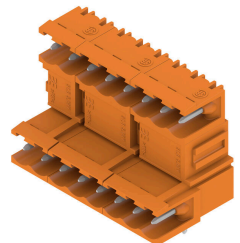

Pin headers with solder pin length optimised for wave flow soldering. The male connectors provide space for labelling and can be coded. HC = High Current.

General ordering data

Type	SLD 5.08V/28/90 3.2 SN ...	Version
Order No.	1725290000	PCB plug-in connector, male header, open side, THT solder
GTIN (EAN)	4032248060696	connection, 5.08 mm, Number of poles: 28, 90°, Solder pin length (l):
Qty.	10 ST	3.2 mm, tinned, orange, Box

BLZP 5.08HC/14/90 SN BK BX

Weidmüller Interface GmbH & Co. KG
 Klingenbergstraße 26
 D-32758 Detmold
 Germany

Counterpart

www.weidmueller.com

SL-SMT 5.08/180 Box

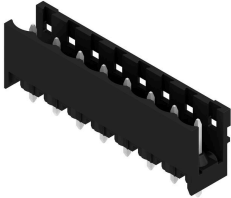

High-temperature-resistant, straight, open pin header. Packed in box or tape. On tape and with 1.5 mm solder pin, optimised for automatic assembly. 3.2 mm solder pin suitable for reflow and wave soldering. The pin headers provide space for labelling and can be coded. HC = High Current.

General ordering data

Type	SL-SMT 5.08HC/14/180 1...	Version
Order No.	1775722001	PCB plug-in connector, male header, open side, THT/THR solder connection, 5.08 mm, Number of poles: 14, 180°, Solder pin length (l): 1.5 mm, tinned, black, Box
GTIN (EAN)	4032248158379	
Qty.	50 ST	
Type	SL-SMT 5.08HC/14/180 3...	Version
Order No.	1838100000	PCB plug-in connector, male header, open side, THT/THR solder connection, 5.08 mm, Number of poles: 14, 180°, Solder pin length (l): 3.2 mm, tinned, black, Box
GTIN (EAN)	4032248348169	
Qty.	50 ST	

SL-SMT 5.08/180G Box

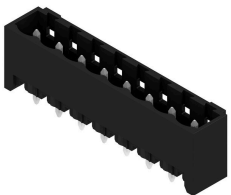

High-temperature-resistant pin header, packed in box or tape. On tape, with 1.5 mm solder pin, optimised for automatic assembly. 3.2 mm solder pin suitable for reflow and wave soldering. The pin headers provide space for labelling and can be coded. HC = High Current.

General ordering data

Type	SL-SMT 5.08HC/14/180G 1...	Version
Order No.	1776252001	PCB plug-in connector, male header, closed side, THT/THR solder connection, 5.08 mm, Number of poles: 14, 180°, Solder pin length (l): 1.5 mm, tinned, black, Box
GTIN (EAN)	4032248159031	
Qty.	50 ST	
Type	SL-SMT 5.08HC/14/180G 3...	Version
Order No.	1838330000	PCB plug-in connector, male header, closed side, THT/THR solder connection, 5.08 mm, Number of poles: 14, 180°, Solder pin length (l): 3.2 mm, tinned, black, Box
GTIN (EAN)	4032248348398	
Qty.	50 ST	

BLZP 5.08HC/14/90 SN BK BX

Weidmüller Interface GmbH & Co. KG
Klingenbergstraße 26
D-32758 Detmold
Germany

www.weidmueller.com

Counterpart

SL-SMT 5.08HC/90 Box



High-temperature-resistant, 90° angled, open male header. Packed in box or tape. On tape, with 1.5 mm solder pin, optimised for automatic assembly. 3.2 mm solder pin suitable for reflow and wave soldering. The pin headers provide space for labelling and can be coded. HC = High Current.

General ordering data

Type	SL-SMT 5.08HC/14/90 3.2...	Version
Order No.	1780070000	PCB plug-in connector, male header, open side, THT/THR solder
GTIN (EAN)	4032248 165391	connection, 5.08 mm, Number of poles: 14, 90°, Solder pin length (l):
Qty.	50 ST	3.2 mm, tinned, black, Box

SL-SMT 5.08HC/90G Box



High-temperature-resistant pin header, packed in box or tape. On tape, with 1.5 mm solder pin, optimised for automatic assembly. 3.2 mm solder pin suitable for reflow and wave soldering. The pin headers provide space for labelling and can be coded. HC = High Current.

General ordering data

Type	SL-SMT 5.08HC/14/90G 3....	Version
Order No.	1780300000	PCB plug-in connector, male header, closed side, THT/THR solder
GTIN (EAN)	4032248 165629	connection, 5.08 mm, Number of poles: 14, 90°, Solder pin length (l):
Qty.	50 ST	3.2 mm, tinned, black, Box

SLT 5.08B

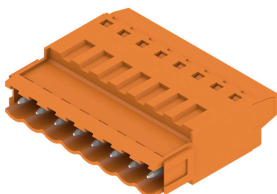

Male plugs with screw TOP wire connection. The male plug provides space for labelling and can be coded.

General ordering data

Type	SLT 5.08/14/180B SN OR ...	Version
Order No.	1611830000	PCB plug-in connector, male plug, 5.08 mm, Number of poles: 14,
GTIN (EAN)	4008 190 1927 16	180°, TOP connection, Clamping range, max.: 2.5 mm², Box
Qty.	50 ST	

BLZP 5.08HC/14/90 SN BK BX

Weidmüller Interface GmbH & Co. KG
 Klingenbergstraße 26
 D-32758 Detmold
 Germany

www.weidmueller.com

Counterpart

SLS 5.08/180 SN

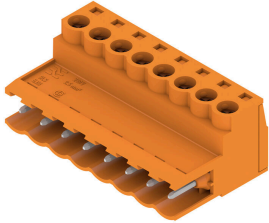

Male plugs with clamping-yoke screw wire-connect system. The male plugs provide space for labelling and can be coded.

General ordering data

Type	SLS 5.08/14/180 SN OR BX	Version	
Order No.	1627210000	PCB plug-in connector, male plug, 5.08 mm, Number of poles: 14,	
GTIN (EAN)	4008190199722	180°, Clamping yoke connection, Clamping range, max. : 3.31 mm²,	
Qty.	24 ST	Box	

SLS 5.08/180B

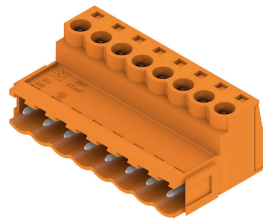

Male plugs with clamping-yoke screw wire-connect system. The male plugs provide space for labelling and can be coded.

General ordering data

Type	SLS 5.08/14/180B SN OR ...	Version	
Order No.	1627360000	PCB plug-in connector, male plug, 5.08 mm, Number of poles: 14,	
GTIN (EAN)	4008190199876	180°, Clamping yoke connection, Clamping range, max. : 3.31 mm²,	
Qty.	24 ST	Box	