

BLZP 5.08HC/22/90 SN OR BX

Weidmüller Interface GmbH & Co. KG

Klingenbergstraße 26

D-32758 Detmold

Germany

www.weidmueller.com

Product image

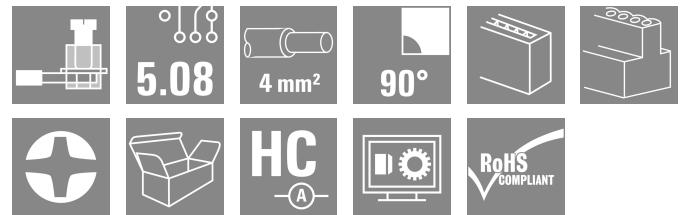
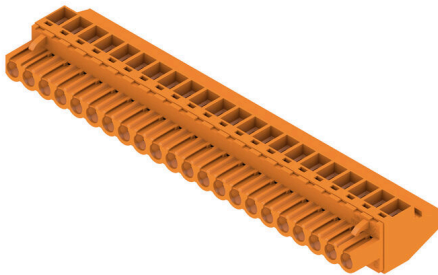

Female plugs with clamping-yoke connection for connecting wires with a right-angle (90° or 270°) outlet direction. The female connectors provide space for labelling and can be coded. Fastened by means of a flange or release latch. They also provide an integrated plus/minus screw, protection against faulty insertion of the wire, and they are delivered with open clamping yokes. HC = High Current.

General ordering data

Version	PCB plug-in connector, female plug, 5.08 mm, Number of poles: 22, 90°, Clamping yoke connection, Clamping range, max. : 4 mm ² , Box
Order No.	1948210000
Type	BLZP 5.08HC/22/90 SN OR BX
GTIN (EAN)	4032248624737
Qty.	12 items
Product data	IEC: 400 V / 23 A / 0.2 - 4 mm ² UL: 300 V / 20 A / AWG 26 - AWG 12
Packaging	Box
Delivery status	This article will no longer be available in the future.
Last order date	2026-10-31T00:00:00+01:00

Creation date 04.05.2026 06:56:54 MEZ

Catalogue status / Drawings

BLZP 5.08HC/22/90 SN OR BX

Weidmüller Interface GmbH & Co. KG
 Klingenbergstraße 26
 D-32758 Detmold
 Germany

www.weidmueller.com

Technical data

Approvals

Approvals



ROHS	Conform
UL File Number Search	UL Website
Certificate No. (cURus)	E60693

Dimensions and weights

Depth	27.2 mm	Depth (inches)	1.0709 inch
Height	14.1 mm	Height (inches)	0.5551 inch
Width	111.76 mm	Width (inches)	4.4 inch
Net weight	40.3 g		

Environmental Product Compliance

RoHS Compliance Status	Compliant without exemption
REACH SVHC	No SVHC above 0.1 wt%

System Parameters

Product family	OMNIMATE Signal - series BL/SL 5.08		
Type of connection	Field connection		
Wire connection method	Clamping yoke connection		
Pitch in mm (P)	5.08 mm		
Pitch in inches (P)	0.200 "		
Conductor outlet direction	90°		
Number of poles	22		
L1 in mm	106.68 mm		
L1 in inches	4.200 "		
Number of rows	1		
Pin series quantity	1		
Rated cross-section	4 mm ²		
Touch-safe protection acc. to DIN VDE 57 106	Safe from finger touch		
Touch-safe protection acc. to DIN VDE 0470	IP20 plugged/ IP10 unplugged		
Protection degree	IP20		
Volume resistance	≤5 mΩ		
Can be coded	Yes		
Stripping length	7 mm		
Clamping screw	M 2.5		
Screwdriver blade	0.6 x 3.5, PH 1, PZ 1		
Screwdriver blade standard	DIN 5264, ISO 8764/2-PH, ISO 8764/2-PZ		
Plugging cycles	25		
Plugging force/pole, max.	10 N		
Pulling force/pole, max.	9 N		
Tightening torque	Torque type	Wire connection	
	Usage information	Tightening torque	min. 0.4 Nm max. 0.5 Nm

BLZP 5.08HC/22/90 SN OR BX

Weidmüller Interface GmbH & Co. KG
 Klingenbergstraße 26
 D-32758 Detmold
 Germany

www.weidmueller.com

Technical data

Material data

Insulating material	PBT	Colour	orange
Colour chart (similar)	RAL 2000	Insulating material group	Illa
Comparative Tracking Index (CTI)	≥ 200	Moisture Level (MSL)	
UL 94 flammability rating	V-0	Contact material	Cu-alloy
Contact surface	tinned	Layer structure of plug contact	4...8 µm Sn hot-dip tinned
Storage temperature, min.	-40 °C	Storage temperature, max.	70 °C
Operating temperature, min.	-50 °C	Operating temperature, max.	100 °C
Temperature range, installation, min.	-25 °C	Temperature range, installation, max.	100 °C

Conductors suitable for connection

Clamping range, min.	0.13 mm ²
Clamping range, max.	4 mm ²
Wire connection cross section AWG, min.	AWG 30
Wire connection cross section AWG, max.	AWG 12
Solid, min. H05(07) V-U	0.2 mm ²
Solid, max. H05(07) V-U	4 mm ²
Flexible, min. H05(07) V-K	0.2 mm ²
Flexible, max. H05(07) V-K	4 mm ²
w. plastic collar ferrule, DIN 46228 pt 4, min.	0.2 mm ²
w. plastic collar ferrule, DIN 46228 pt 4, max.	2.5 mm ²
w. wire end ferrule, DIN 46228 pt 1, min.	0.2 mm ²
w. wire end ferrule, DIN 46228 pt 1, max.	4 mm ²
Plug gauge in accordance with EN 60999 a x b; ø	2.8 mm x 2.4 mm

Clampable conductor	Cross-section for conductor connection wire end ferrule	nominal	0.5 mm ²
		Stripping length	nominal 6 mm
		Recommended wire-end ferrule	H0,5/6
		Stripping length	nominal 8 mm
	Cross-section for conductor connection wire end ferrule	nominal	1 mm ²
		Stripping length	nominal 6 mm
		Recommended wire-end ferrule	H1,0/6
		Stripping length	nominal 8 mm
	Cross-section for conductor connection wire end ferrule	nominal	1.5 mm ²
		Stripping length	nominal 7 mm
		Recommended wire-end ferrule	H1,5/7
		Stripping length	nominal 10 mm
	Cross-section for conductor connection wire end ferrule	nominal	2.5 mm ²
		Stripping length	nominal 7 mm
		Recommended wire-end ferrule	H2,5/7
		Stripping length	nominal 10 mm
	Cross-section for conductor connection wire end ferrule	nominal	2.5 mm ²
		Stripping length	nominal 7 mm
		Recommended wire-end ferrule	H2,5/15D BL
		Stripping length	nominal 10 mm

Reference text The outside diameter of the plastic collar should not be larger than the pitch (P). Length of ferrules is to be chosen depending on the product and the rated voltage.

BLZP 5.08HC/22/90 SN OR BX

Weidmüller Interface GmbH & Co. KG

Klingenbergstraße 26
D-32758 Detmold
Germany

www.weidmueller.com

Technical data

Rated data acc. to IEC

tested acc. to standard	IEC 60664-1, IEC 61984	Rated current, min. number of poles (Tu=20°C)	23 A
Rated current, max. number of poles (Tu=20°C)	18 A	Rated current, min. number of poles (Tu=40°C)	21 A
Rated current, max. number of poles (Tu=40°C)	16 A	Rated voltage for surge voltage class / pollution degree II/2	400 V
Rated voltage for surge voltage class / pollution degree III/2	320 V	Rated voltage for surge voltage class / pollution degree III/3	250 V
Rated impulse voltage for surge voltage class/ pollution degree II/2	4 kV	Rated impulse voltage for surge voltage class/ pollution degree III/2	4 kV
Rated impulse voltage for surge voltage class/ contamination degree III/3	4 kV	Short-time withstand current resistance	3 x 1s with 120 A

Rated data acc. to CSA

Institute (CSA)	CSA	Certificate No. (CSA)	200039-1121690
Rated voltage (Use group B / CSA)	300 V	Rated voltage (Use group C / CSA)	50 V
Rated voltage (Use group D / CSA)	300 V	Rated current (Use group B / CSA)	20 A
Rated current (Use group D / CSA)	20 A	Wire cross-section, AWG, min.	AWG 30
Wire cross-section, AWG, max.	AWG 12	Reference to approval values	Specifications are maximum values, details - see approval certificate.

Rated data acc. to UL 1059

Institute (cURus)	CURUS	Certificate No. (cURus)	E60693
Rated voltage (Use group B / UL 1059)	300 V	Rated voltage (Use group D / UL 1059)	300 V
Rated current (Use group B / UL 1059)	20 A	Rated current (Use group D / UL 1059)	10 A
Wire cross-section, AWG, min.	AWG 26	Wire cross-section, AWG, max.	AWG 12
Reference to approval values	Specifications are maximum values, details - see approval certificate.		

Packing

Packaging	Box	VPE length	350.00 mm
VPE width	145.00 mm	VPE height	35.00 mm

Type tests

Test: Durability of markings	Standard	DIN EN 61984 section 7.3.2 / 09.02 taking pattern from DIN EN 60068-2-70 / 07.96	
	Test	mark of origin, rated voltage, rated cross-section, type of material	
	Evaluation	available	
	Test	durability	
Test: Misengagement (Non-interchangeability)	Evaluation	passed	
	Standard	DIN EN 60512-13-5 / 11.06, IEC 60512-13-5 / 02.06	
	Test	180° turned with coding elements	
	Evaluation	passed	
Test: Clampable cross section	Test	visual examination	
	Evaluation	passed	
	Standard	DIN EN 60999-1 section 7 and 9.1 / 12.00, DIN EN 60947-1 section 8.2.4.5.1 / 12.02	
	Conductor type	Type of conductor	solid 0.2 mm ² and conductor cross-section

BLZP 5.08HC/22/90 SN OR BX

Weidmüller Interface GmbH & Co. KG
 Klingenbergstraße 26
 D-32758 Detmold
 Germany

www.weidmueller.com

Technical data

		Type of conductor and conductor cross-section	stranded 0.2 mm ²	
		Type of conductor and conductor cross-section	solid 2.5 mm ²	
		Type of conductor and conductor cross-section	stranded 2.5 mm ²	
		Type of conductor and conductor cross-section	AWG 26/1	
		Type of conductor and conductor cross-section	AWG 26/19	
	Evaluation	passed		
Test for damage to and accidental loosening of conductors	Standard	DIN EN 60999-1 section 9.4 / 12.00		
	Requirement	0.2 kg		
	Conductor type	Type of conductor and conductor cross-section	AWG 26/1	
		Type of conductor and conductor cross-section	AWG 26/19	
	Evaluation	passed		
	Requirement	0.3 kg		
	Conductor type	Type of conductor and conductor cross-section	solid 0.5 mm ²	
		Type of conductor and conductor cross-section	stranded 0.5 mm ²	
	Evaluation	passed		
	Requirement	0.9 kg		
Pull-out test	Conductor type	Type of conductor and conductor cross-section	AWG 12/1	
		Type of conductor and conductor cross-section	AWG 12/19	
	Evaluation	passed		
	Standard	DIN EN 60999-1 section 9.5 / 12.00		
	Requirement	≥10 N		
	Conductor type	Type of conductor and conductor cross-section	AWG 26/1	
		Type of conductor and conductor cross-section	AWG 26/19	
	Evaluation	passed		
	Requirement	≥20 N		
	Conductor type	Type of conductor and conductor cross-section	H05V-U0.5	
Type of conductor and conductor cross-section		H05V-K0.5		
Evaluation	passed			
Requirement	≥60 N			
Conductor type	Type of conductor and conductor cross-section	H07V-U4.0		

BLZP 5.08HC/22/90 SN OR BX

Weidmüller Interface GmbH & Co. KG
 Klingenbergstraße 26
 D-32758 Detmold
 Germany

www.weidmueller.com

Technical data

	Type of conductor and conductor cross-section	H07V-K4.0
	Type of conductor and conductor cross-section	AWG 12/1
	Type of conductor and conductor cross-section	AWG 12/19
Evaluation	passed	

Important note

IPC conformity	Conformity: The products are developed, manufactured and delivered according international recognized standards and norms and comply with the assured properties in the data sheet resp. fulfill decorative properties in accordance with IPC-A-610 "Class 2". Further claims on the products can be evaluated on request.
Notes	<ul style="list-style-type: none"> • Additional variants on request • Gold-plated contact surfaces on request • Rated current related to rated cross-section & min. No. of poles. • Wire end ferrule without plastic collar to DIN 46228/1 • Wire end ferrule with plastic collar to DIN 46228/4 • P on drawing = pitch • Rated data refer only to the component itself. Clearance and creepage distances to other components are to be designed in accordance with the relevant application standards. • In accordance with IEC 61984, OMNIMATE-connectors are connectors without breaking capacity (COC). During designated use, connectors are not allowed to be engaged or disengaged when live or under load • Long term storage of the product with average temperature of 50 °C and maximum humidity 70%, 36 months

Classifications

ETIM 8.0	EC002638	ETIM 9.0	EC002638
ETIM 10.0	EC002638	ECLASS 14.0	27-46-02-02
ECLASS 15.0	27-46-02-02		

BLZP 5.08HC/22/90 SN OR BX

Weidmüller Interface GmbH & Co. KG
Klingenbergstraße 26
D-32758 Detmold
Germany

www.weidmueller.com

Drawings

Product image

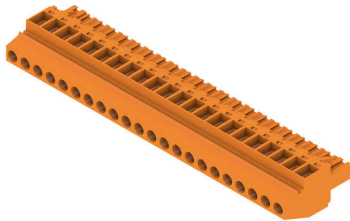

Dimensional drawing

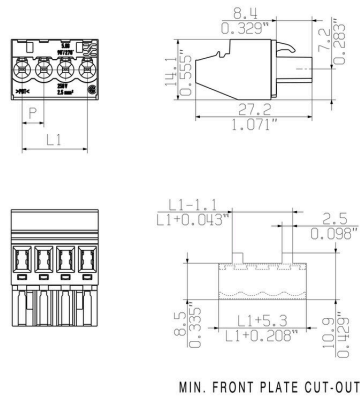

BLZP 5.08HC/22/90 SN OR BX

Weidmüller Interface GmbH & Co. KG
 Klingenbergstraße 26
 D-32758 Detmold
 Germany

www.weidmueller.com

Accessories

Coding elements



Only connects what is supposed to be connected: the right connection at the right place.
 Coding elements and locking devices clearly assign connecting elements during the manufacturing process and operation
 The coding elements and locking devices are inserted prior to assembly or during the cable assembly phase.
 The Weidmüller alternative: configure online using the variant configurator to precode prior to delivery.
 Incorrect assembly on the circuit board and incorrect plugging of connecting elements is no longer possible.
 The advantage: no troubleshooting during manufacture and no operational errors by the user.

General ordering data

Type	BLZ/SL KO OR BX	Version
Order No.	1573010000	PCB plug-in connector, Accessories, Coding element, orange, Number
GTIN (EAN)	4008190048396	of poles: 1
Qty.	100 ST	
Type	BLZ/SL KO BK BX	Version
Order No.	1545710000	PCB plug-in connector, Accessories, Coding element, black, Number
GTIN (EAN)	4008190087142	of poles: 1
Qty.	50 ST	

Slotted screwdriver

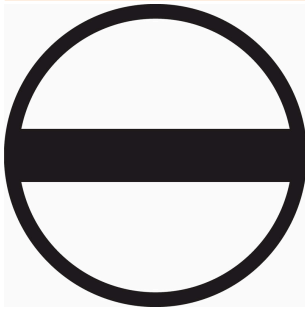

Slotted screwdriver with rounded blade SD DIN 5265, ISO 2380/2, output to DIN 5264, ISO 2380/1.
 ChromTop tip, SoftFinish grip

General ordering data

Type	SDS 0.6X3.5X100	Version
Order No.	2749340000	Screwdriver, Blade width (B): 3.5 mm, Blade length: 100 mm, Blade thickness (A): 0.6 mm
GTIN (EAN)	4050118895568	
Qty.	1 ST	
Type	SDIS 0.6X3.5X100	Version
Order No.	2749810000	Screwdriver, Blade width (B): 3.5 mm, Blade length: 100 mm, Blade thickness (A): 0.6 mm
GTIN (EAN)	4050118897012	
Qty.	1 ST	

BLZP 5.08HC/22/90 SN OR BX

Weidmüller Interface GmbH & Co. KG
 Klingenbergstraße 26
 D-32758 Detmold
 Germany

www.weidmueller.com

Accessories

Crosshead screwdriver Phillips



Crosshead screwdriver, Phillips, SDK PH DIN 5262, ISO 8764/2-PH, output to ISO 8764-PH, ChromTop tip, SoftFinish grip

General ordering data

Type	SDK PH1 X 80	Version	
Order No.	2749410000	Screwdriver, Blade width (B): 4.5 mm, 80 mm, Blade thickness (A): 1	
GTIN (EAN)	4050118895636		
Qty.	1 ST		

Crosshead screwdriver Pozidriv



Crosshead screwdriver, Pozidriv, SDK PZ DIN 5262, ISO 8764/2-PZ, output to ISO 8764/1-PZ, ChromTop tip, SoftFinish grip

General ordering data

Type	SDK PZ1 X 80	Version	
Order No.	2749440000	Screwdriver, Blade width (B): 14.5 mm, 80 mm, Blade thickness (A): 1	
GTIN (EAN)	4050118895667		
Qty.	1 ST		

BLZP 5.08HC/22/90 SN OR BX

Weidmüller Interface GmbH & Co. KG
Klingenbergstraße 26
D-32758 Detmold
Germany

www.weidmueller.com

Counterpart

SL 5.08/135



Male connectors with 135° outlet direction. The solder pin length is optimised for wave flow soldering. The pin headers provide space for labelling and can be coded.

General ordering data

Type	SL 5.08/22/135 3.2SN OR...	Version
Order No.	1603260000	PCB plug-in connector, male header, open side, THT solder
GTIN (EAN)	4008190175085	connection, 5.08 mm, Number of poles: 22, 135°, Solder pin length
Qty.	20 ST	(l): 3.2 mm, tinned, orange, Box

SL 5.08/135B



Male connectors with 135° outlet direction. The solder pin length is optimised for wave flow soldering. The pin headers provide space for labelling and can be coded.

General ordering data

Type	SL 5.08/22/135B 3.2SN O...	Version
Order No.	1605730000	PCB plug-in connector, male header, Dovetails for fixing blocks, THT
GTIN (EAN)	4008190186104	solder connection, 5.08 mm, Number of poles: 22, 135°, Solder pin
Qty.	20 ST	length (l): 3.2 mm, tinned, orange, Box

SL 5.08/180

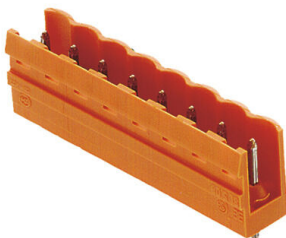

Male connectors with straight outlet direction. The solder pin length is optimised for wave flow soldering. The pin headers provide space for labelling and can be coded.

General ordering data

Type	SL 5.08/22/180 3.2SN OR...	Version
Order No.	1519260000	PCB plug-in connector, male header, open side, THT solder
GTIN (EAN)	4008190069674	connection, 5.08 mm, Number of poles: 22, 180°, Solder pin length
Qty.	20 ST	(l): 3.2 mm, tinned, orange, Box

BLZP 5.08HC/22/90 SN OR BX

Weidmüller Interface GmbH & Co. KG
 Klingenbergstraße 26
 D-32758 Detmold
 Germany

www.weidmuller.com

Counterpart

SL 5.08/180B

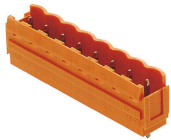

Male connectors with straight outlet direction. The solder pin length is optimised for wave flow soldering. The pin headers provide space for labelling and can be coded.

General ordering data

Type	SL 5.08/22/180B 3.2SN O...	Version
Order No.	1521560000	PCB plug-in connector, male header, Dovetails for fixing blocks, THT
GTIN (EAN)	4008190016517	solder connection, 5.08 mm, Number of poles: 22, 180°, Solder pin
Qty.	20 ST	length (l): 3.2 mm, tinned, orange, Box

SL 5.08/90



Male connectors with 90° outlet direction. The solder pin length is optimised for wave flow soldering. The pin headers provide space for labelling and can be coded.

General ordering data

Type	SL 5.08/22/90 3.2SN OR ...	Version
Order No.	1510060000	PCB plug-in connector, male header, open side, THT solder
GTIN (EAN)	4008190001681	connection, 5.08 mm, Number of poles: 22, 90°, Solder pin length (l):
Qty.	20 ST	3.2 mm, tinned, orange, Box

SL 5.08/90B

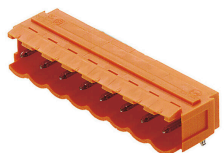

Male connectors with 90° outlet direction. The solder pin length is optimised for wave flow soldering. The pin headers provide space for labelling and can be coded.

General ordering data

Type	SL 5.08/22/90B 3.2SN OR...	Version
Order No.	1512360000	PCB plug-in connector, male header, Dovetails for fixing blocks, THT
GTIN (EAN)	4008190123970	solder connection, 5.08 mm, Number of poles: 22, 90°, Solder pin
Qty.	20 ST	length (l): 3.2 mm, tinned, orange, Box

BLZP 5.08HC/22/90 SN OR BX

Weidmüller Interface GmbH & Co. KG
 Klingenbergstraße 26
 D-32758 Detmold
 Germany

Counterpart

www.weidmueller.com

SL 5.08HC/180

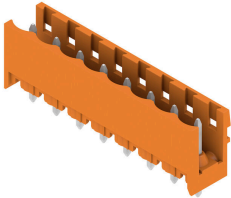

Pin headers in glass-fibre-reinforced plastic with straight wire outlet; optimised for wave soldering. The flange variant (F) can be screwed onto the respective counter piece or the circuit board. There is no need for an extra screw to connect the circuit board when the solder flange (LF) version is used. This also protects the solder points from mechanical strain. All pin headers can be manually coded or ordered pre-coded. HC = High Current.

General ordering data

Type	SL 5.08HC/22/180 3.2SN ...	Version
Order No.	1148550000	PCB plug-in connector, male header, open side, THT solder
GTIN (EAN)	4032248934508	connection, 5.08 mm, Number of poles: 22, 180°, Solder pin length
Qty.	20 ST	(l): 3.2 mm, tinned, black, Box
Type	SL 5.08HC/22/180 3.2SN ...	Version
Order No.	1146690000	PCB plug-in connector, male header, open side, THT solder
GTIN (EAN)	4032248933570	connection, 5.08 mm, Number of poles: 22, 180°, Solder pin length
Qty.	20 ST	(l): 3.2 mm, tinned, orange, Box

SL 5.08HC/180B

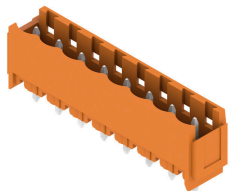

Pin headers in glass-fibre-reinforced plastic with straight wire outlet; optimised for wave soldering. The flange variant (F) can be screwed onto the respective counter piece or the circuit board. There is no need for an extra screw to connect the circuit board when the solder flange (LF) version is used. This also protects the solder points from mechanical strain. All pin headers can be manually coded or ordered pre-coded. HC = High Current.

General ordering data

Type	SL 5.08HC/22/180B 3.2SN...	Version
Order No.	1150030000	PCB plug-in connector, male header, Dovetails for fixing blocks, THT
GTIN (EAN)	4032248935567	solder connection, 5.08 mm, Number of poles: 22, 180°, Solder pin
Qty.	20 ST	length (l): 3.2 mm, tinned, black, Box
Type	SL 5.08HC/22/180B 3.2SN...	Version
Order No.	1147970000	PCB plug-in connector, male header, Dovetails for fixing blocks, THT
GTIN (EAN)	4032248934362	solder connection, 5.08 mm, Number of poles: 22, 180°, Solder pin
Qty.	20 ST	length (l): 3.2 mm, tinned, orange, Box

BLZP 5.08HC/22/90 SN OR BX

Weidmüller Interface GmbH & Co. KG
Klingenbergstraße 26
D-32758 Detmold
Germany

Counterpart

www.weidmueller.com

SL 5.08HC/180G

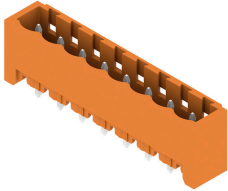

Pin headers in glass-fibre-reinforced plastic with straight wire outlet; optimised for wave soldering. The flange variant (F) can be screwed onto the respective counter piece or the circuit board. There is no need for an extra screw to connect the circuit board when the solder flange (LF) version is used. This also protects the solder points from mechanical strain. All pin headers can be manually coded or ordered pre-coded. HC = High Current.

General ordering data

Type	SL 5.08HC/22/180G 3.2SN...	Version
Order No.	1149300000	PCB plug-in connector, male header, closed side, THT solder
GTIN (EAN)	4032248935284	connection, 5.08 mm, Number of poles: 22, 180°, Solder pin length
Qty.	20 ST	(l): 3.2 mm, tinned, black, Box
Type	SL 5.08HC/22/180G 3.2SN...	Version
Order No.	1147210000	PCB plug-in connector, male header, closed side, THT solder
GTIN (EAN)	4032248933143	connection, 5.08 mm, Number of poles: 22, 180°, Solder pin length
Qty.	20 ST	(l): 3.2 mm, tinned, orange, Box

SL 5.08HC/90

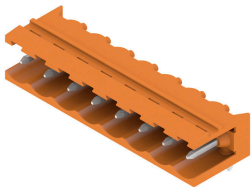

Pin headers made from glass-fibre-reinforced plastic with 90° wire outlet; optimised for wave soldering. The flange variant (F) can be screwed onto the respective counter piece or the circuit board. There is no need for an extra screw to connect the circuit board when the solder flange (LF) version is used. This also protects the solder points from mechanical strain. All pin headers can be manually coded or ordered pre-coded. HC = High Current.

General ordering data

Type	SL 5.08HC/22/90 3.2SN B...	Version
Order No.	1155290000	PCB plug-in connector, male header, open side, THT solder
GTIN (EAN)	4050118050615	connection, 5.08 mm, Number of poles: 22, 90°, Solder pin length (l):
Qty.	20 ST	3.2 mm, tinned, black, Box
Type	SL 5.08HC/22/90 3.2SN O...	Version
Order No.	1147190000	PCB plug-in connector, male header, open side, THT solder
GTIN (EAN)	4050118051308	connection, 5.08 mm, Number of poles: 22, 90°, Solder pin length (l):
Qty.	20 ST	3.2 mm, tinned, orange, Box

BLZP 5.08HC/22/90 SN OR BX

Weidmüller Interface GmbH & Co. KG
Klingenbergstraße 26
D-32758 Detmold
Germany

Counterpart

www.weidmueller.com

SL 5.08HC/90B

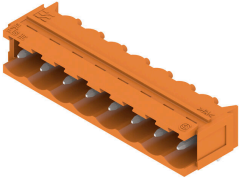

Pin headers made from glass-fibre-reinforced plastic with 90° wire outlet; optimised for wave soldering. The flange variant (F) can be screwed onto the respective counter piece or the circuit board. There is no need for an extra screw to connect the circuit board when the solder flange (LF) version is used. This also protects the solder points from mechanical strain. All pin headers can be manually coded or ordered pre-coded. HC = High Current.

General ordering data

Type	SL 5.08HC/22/90B 3.2SN ...	Version
Order No.	1155800000	PCB plug-in connector, male header, Dovetails for fixing blocks, THT
GTIN (EAN)	4050118049954	solder connection, 5.08 mm, Number of poles: 22, 90°, Solder pin
Qty.	20 ST	length (l): 3.2 mm, tinned, black, Box
Type	SL 5.08HC/22/90B 3.2SN ...	Version
Order No.	1154990000	PCB plug-in connector, male header, Dovetails for fixing blocks, THT
GTIN (EAN)	4050118050844	solder connection, 5.08 mm, Number of poles: 22, 90°, Solder pin
Qty.	20 ST	length (l): 3.2 mm, tinned, orange, Box

SLDV 5.08/180

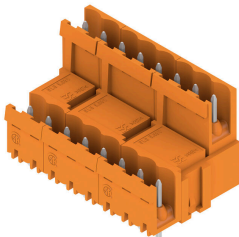

Pin headers with solder pin length optimised for wave flow soldering. The male connectors provide space for labelling and can be coded. HC = High Current.

General ordering data

Type	SLD 5.08V/44/180 3.2SN ...	Version
Order No.	1725850000	PCB plug-in connector, male header, open side, THT solder
GTIN (EAN)	4032248062140	connection, 5.08 mm, Number of poles: 44, 180°, Solder pin length
Qty.	10 ST	(l): 3.2 mm, tinned, orange, Box

SLDV 5.08/180B

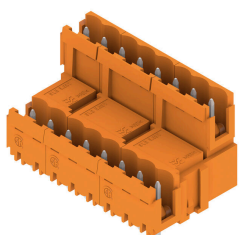

Pin headers with solder pin length optimised for wave flow soldering. The male connectors provide space for labelling and can be coded. HC = High Current.

BLZP 5.08HC/22/90 SN OR BX

Weidmüller Interface GmbH & Co. KG
 Klingenbergstraße 26
 D-32758 Detmold
 Germany

www.weidmueller.com

Counterpart

General ordering data

Type	SLD 5.08V/44/180B 3.2SN...	Version
Order No.	1726940000	PCB plug-in connector, male header, Dovetails for fixing blocks, THT
GTIN (EAN)	4032248062836	solder connection, 5.08 mm, Number of poles: 44, 180°, Solder pin
Qty.	10 ST	length (l): 3.2 mm, tinned, orange, Box

SLDV 5.08/90

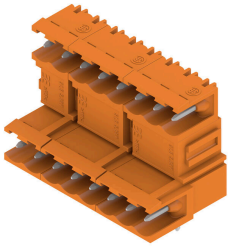

Pin headers with solder pin length optimised for wave flow soldering. The male connectors provide space for labelling and can be coded. HC = High Current.

General ordering data

Type	SLD 5.08V/44/90 3.2 SN ...	Version
Order No.	1725370000	PCB plug-in connector, male header, open side, THT solder
GTIN (EAN)	4032248060771	connection, 5.08 mm, Number of poles: 44, 90°, Solder pin length (l):
Qty.	10 ST	3.2 mm, tinned, orange, Box

SLDV 5.08/90B

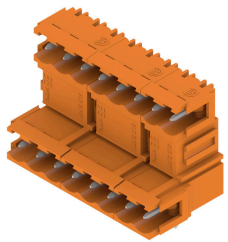

Pin headers with solder pin length optimised for wave flow soldering. The male connectors provide space for labelling and can be coded. HC = High Current.

General ordering data

Type	SLD 5.08V/44/90B 3.2 SN...	Version
Order No.	1726480000	PCB plug-in connector, male header, Dovetails for fixing blocks, THT
GTIN (EAN)	4032248061457	solder connection, 5.08 mm, Number of poles: 44, 90°, Solder pin
Qty.	10 ST	length (l): 3.2 mm, tinned, orange, Box

BLZP 5.08HC/22/90 SN OR BX

Weidmüller Interface GmbH & Co. KG
 Klingenbergstraße 26
 D-32758 Detmold
 Germany

www.weidmueller.com

Counterpart

SL-SMT 5.08/180 Box

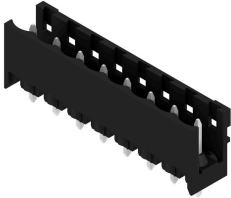

High-temperature-resistant, straight, open pin header. Packed in box or tape. On tape and with 1.5 mm solder pin, optimised for automatic assembly. 3.2 mm solder pin suitable for reflow and wave soldering. The pin headers provide space for labelling and can be coded. HC = High Current.

General ordering data

Type	SL-SMT 5.08HC/22/180 3...	Version
Order No.	1838180000	PCB plug-in connector, male header, open side, THT/THR solder connection, 5.08 mm, Number of poles: 22, 180°, Solder pin length (l): 3.2 mm, tinned, black, Box
GTIN (EAN)	4032248348244	
Qty.	20 ST	

SL-SMT 5.08/180G Box

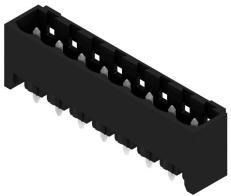

High-temperature-resistant pin header, packed in box or tape. On tape, with 1.5 mm solder pin, optimised for automatic assembly. 3.2 mm solder pin suitable for reflow and wave soldering. The pin headers provide space for labelling and can be coded. HC = High Current.

General ordering data

Type	SL-SMT 5.08HC/22/180G 3...	Version
Order No.	1838410000	PCB plug-in connector, male header, closed side, THT/THR solder connection, 5.08 mm, Number of poles: 22, 180°, Solder pin length (l): 3.2 mm, tinned, black, Box
GTIN (EAN)	4032248348473	
Qty.	20 ST	

SL-SMT 5.08HC/90 Box



High-temperature-resistant, 90° angled, open male header. Packed in box or tape. On tape, with 1.5 mm solder pin, optimised for automatic assembly. 3.2 mm solder pin suitable for reflow and wave soldering. The pin headers provide space for labelling and can be coded. HC = High Current.

General ordering data

Type	SL-SMT 5.08HC/22/90 3.2...	Version
Order No.	1780150000	PCB plug-in connector, male header, open side, THT/THR solder connection, 5.08 mm, Number of poles: 22, 90°, Solder pin length (l): 3.2 mm, tinned, black, Box
GTIN (EAN)	4032248165476	
Qty.	20 ST	

BLZP 5.08HC/22/90 SN OR BX

Weidmüller Interface GmbH & Co. KG
 Klingenbergstraße 26
 D-32758 Detmold
 Germany

www.weidmueller.com

Counterpart

SL-SMT 5.08HC/90G Box



High-temperature-resistant pin header, packed in box or tape. On tape, with 1.5 mm solder pin, optimised for automatic assembly. 3.2 mm solder pin suitable for reflow and wave soldering. The pin headers provide space for labelling and can be coded. HC = High Current.

General ordering data

Type	SL-SMT 5.08HC/22/90G 3...	Version
Order No.	1780380000	PCB plug-in connector, male header, closed side, THT/THR solder connection, 5.08 mm, Number of poles: 22, 90°, Solder pin length (l):
GTIN (EAN)	4032248165704	3.2 mm, tinned, black, Box
Qty.	20 ST	

SLS 5.08/180B

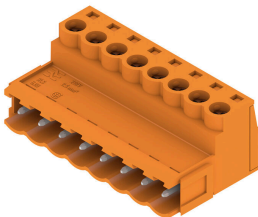

Male plugs with clamping-yoke screw wire-connect system. The male plugs provide space for labelling and can be coded.

General ordering data

Type	SLS 5.08/22/180B SN OR ...	Version
Order No.	1645200000	PCB plug-in connector, male plug, 5.08 mm, Number of poles: 22,
GTIN (EAN)	4008190284411	180°, Clamping yoke connection, Clamping range, max. : 3.31 mm²,
Qty.	12 ST	Box