

## BLZP 5.08HC/03/90 SN OR BX

**Weidmüller Interface GmbH & Co. KG**  
 Klingenbergstraße 26  
 D-32758 Detmold  
 Germany

www.weidmueller.com

### Product image

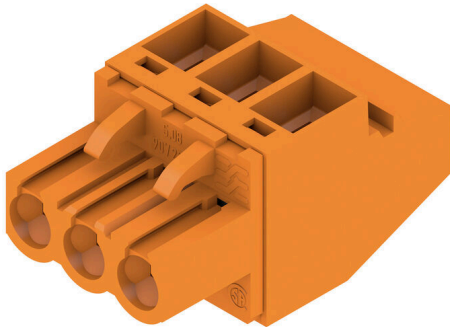

Female plugs with clamping-yoke connection for connecting wires with a right-angle (90° or 270°) outlet direction. The female connectors provide space for labelling and can be coded. Fastened by means of a flange or release latch. They also provide an integrated plus/minus screw, protection against faulty insertion of the wire, and they are delivered with open clamping yokes. HC = High Current.

### General ordering data

Version	PCB plug-in connector, female plug, 5.08 mm, Number of poles: 3, 90°, Clamping yoke connection, Clamping range, max. : 4 mm², Box
Order No.	<a href="#">1948010000</a>
Type	BLZP 5.08HC/03/90 SN OR BX
GTIN (EAN)	4032248624232
Qty.	120 items
Product data	IEC: 400 V / 23 A / 0.2 - 4 mm² UL: 300 V / 20 A / AWG 26 - AWG 12
Packaging	Box

**BLZP 5.08HC/03/90 SN OR BX**

**Weidmüller Interface GmbH & Co. KG**  
 Klingenbergstraße 26  
 D-32758 Detmold  
 Germany

www.weidmueller.com

**Technical data**

**Approvals**

Approvals



ROHS	Conform
UL File Number Search	<a href="#">UL Website</a>
Certificate No. (cURus)	E60693

**Dimensions and weights**

Depth	27.2 mm	Depth (inches)	1.0709 inch
Height	14.1 mm	Height (inches)	0.5551 inch
Width	15.24 mm	Width (inches)	0.6 inch
Net weight	5.62 g		

**Environmental Product Compliance**

RoHS Compliance Status	Compliant without exemption		
REACH SVHC	No SVHC above 0.1 wt%		
Product Carbon Footprint	Cradle to gate	0,172 kg CO2 eq.	

**System Parameters**

Product family	OMNIMATE Signal - series BL/SL 5.08		
Type of connection	Field connection		
Wire connection method	Clamping yoke connection		
Pitch in mm (P)	5.08 mm		
Pitch in inches (P)	0.200 "		
Conductor outlet direction	90°		
Number of poles	3		
L1 in mm	10.16 mm		
L1 in inches	0.400 "		
Number of rows	1		
Pin series quantity	1		
Rated cross-section	4 mm <sup>2</sup>		
Touch-safe protection acc. to DIN VDE 57 106	Safe from finger touch		
Touch-safe protection acc. to DIN VDE 0470	IP20 plugged/ IP10 unplugged		
Protection degree	IP20		
Volume resistance	≤5 mΩ		
Can be coded	Yes		
Stripping length	7 mm		
Clamping screw	M 2.5		
Screwdriver blade	0.6 x 3.5, PH 1, PZ 1		
Screwdriver blade standard	DIN 5264, ISO 8764/2-PH, ISO 8764/2-PZ		
Plugging cycles	25		
Plugging force/pole, max.	10 N		
Pulling force/pole, max.	9 N		
Tightening torque	Torque type	Wire connection	
	Usage information	Tightening torque	min. 0.4 Nm max. 0.5 Nm

## BLZP 5.08HC/03/90 SN OR BX

**Weidmüller Interface GmbH & Co. KG**  
 Klingenbergstraße 26  
 D-32758 Detmold  
 Germany

www.weidmueller.com

## Technical data

### Material data

Insulating material	PBT	Colour	orange
Colour chart (similar)	RAL 2000	Insulating material group	Illa
Comparative Tracking Index (CTI)	≥ 200	Moisture Level (MSL)	
UL 94 flammability rating	V-0	Contact material	Cu-alloy
Contact surface	tinned	Layer structure of plug contact	4...8 µm Sn hot-dip tinned
Storage temperature, min.	-40 °C	Storage temperature, max.	70 °C
Operating temperature, min.	-50 °C	Operating temperature, max.	100 °C
Temperature range, installation, min.	-25 °C	Temperature range, installation, max.	100 °C

### Conductors suitable for connection

Clamping range, min.	0.13 mm <sup>2</sup>
Clamping range, max.	4 mm <sup>2</sup>
Wire connection cross section AWG, min.	AWG 30
Wire connection cross section AWG, max.	AWG 12
Solid, min. H05(07) V-U	0.2 mm <sup>2</sup>
Solid, max. H05(07) V-U	4 mm <sup>2</sup>
Flexible, min. H05(07) V-K	0.2 mm <sup>2</sup>
Flexible, max. H05(07) V-K	4 mm <sup>2</sup>
w. plastic collar ferrule, DIN 46228 pt 4, min.	0.2 mm <sup>2</sup>
w. plastic collar ferrule, DIN 46228 pt 4, max.	2.5 mm <sup>2</sup>
w. wire end ferrule, DIN 46228 pt 1, min.	0.2 mm <sup>2</sup>
w. wire end ferrule, DIN 46228 pt 1, max.	4 mm <sup>2</sup>
Plug gauge in accordance with EN 60999 a x b; ø	2.8 mm x 2.4 mm

Clampable conductor	Cross-section for conductor connection wire end ferrule	nominal	0.5 mm <sup>2</sup>
		Stripping length	nominal 6 mm
		Recommended wire-end ferrule	<a href="#">H0,5/6</a>
		Stripping length	nominal 8 mm
	Cross-section for conductor connection wire end ferrule	nominal	1 mm <sup>2</sup>
		Stripping length	nominal 6 mm
		Recommended wire-end ferrule	<a href="#">H1,0/6</a>
		Stripping length	nominal 8 mm
	Cross-section for conductor connection wire end ferrule	nominal	1.5 mm <sup>2</sup>
		Stripping length	nominal 7 mm
		Recommended wire-end ferrule	<a href="#">H1,5/7</a>
		Stripping length	nominal 10 mm
	Cross-section for conductor connection wire end ferrule	nominal	2.5 mm <sup>2</sup>
		Stripping length	nominal 7 mm
		Recommended wire-end ferrule	<a href="#">H2,5/7</a>
		Stripping length	nominal 10 mm
	Cross-section for conductor connection wire end ferrule	nominal	2.5 mm <sup>2</sup>
		Stripping length	nominal 7 mm
		Recommended wire-end ferrule	<a href="#">H2,5/15D BL</a>
		Stripping length	nominal 10 mm

**Reference text** The outside diameter of the plastic collar should not be larger than the pitch (P). Length of ferrules is to be chosen depending on the product and the rated voltage.

## BLZP 5.08HC/03/90 SN OR BX

**Weidmüller Interface GmbH & Co. KG**  
 Klingenbergstraße 26  
 D-32758 Detmold  
 Germany

www.weidmueller.com

## Technical data

### Rated data acc. to IEC

tested acc. to standard	IEC 60664-1, IEC 61984	Rated current, min. number of poles (Tu=20°C)	23 A
Rated current, max. number of poles (Tu=20°C)	18 A	Rated current, min. number of poles (Tu=40°C)	21 A
Rated current, max. number of poles (Tu=40°C)	16 A	Rated voltage for surge voltage class / pollution degree II/2	400 V
Rated voltage for surge voltage class / pollution degree III/2	320 V	Rated voltage for surge voltage class / pollution degree III/3	250 V
Rated impulse voltage for surge voltage class/ pollution degree II/2	4 kV	Rated impulse voltage for surge voltage class/ pollution degree III/2	4 kV
Rated impulse voltage for surge voltage class/ contamination degree III/3	4 kV	Short-time withstand current resistance	3 x 1s with 120 A

### Rated data acc. to CSA

Institute (CSA)	CSA	Certificate No. (CSA)	200039-1121690
Rated voltage (Use group B / CSA)	300 V	Rated voltage (Use group C / CSA)	50 V
Rated voltage (Use group D / CSA)	300 V	Rated current (Use group B / CSA)	20 A
Rated current (Use group D / CSA)	20 A	Wire cross-section, AWG, min.	AWG 30
Wire cross-section, AWG, max.	AWG 12	Reference to approval values	Specifications are maximum values, details - see approval certificate.

### Rated data acc. to UL 1059

Institute (cURus)	CURUS	Certificate No. (cURus)	E60693
Rated voltage (Use group B / UL 1059)	300 V	Rated voltage (Use group D / UL 1059)	300 V
Rated current (Use group B / UL 1059)	20 A	Rated current (Use group D / UL 1059)	10 A
Wire cross-section, AWG, min.	AWG 26	Wire cross-section, AWG, max.	AWG 12
Reference to approval values	Specifications are maximum values, details - see approval certificate.		

### Packing

Packaging	Box	VPE length	350.00 mm
VPE width	135.00 mm	VPE height	33.00 mm

### Type tests

Test: Durability of markings	Standard	DIN EN 61984 section 7.3.2 / 09.02 taking pattern from DIN EN 60068-2-70 / 07.96	
	Test	mark of origin, rated voltage, rated cross-section, type of material	
	Evaluation	available	
	Test	durability	
Test: Misengagement (Non-interchangeability)	Standard	DIN EN 60512-13-5 / 11.06, IEC 60512-13-5 / 02.06	
	Test	180° turned with coding elements	
	Evaluation	passed	
	Test	visual examination	
Test: Clampable cross section	Evaluation	passed	
	Standard	DIN EN 60999-1 section 7 and 9.1 / 12.00, DIN EN 60947-1 section 8.2.4.5.1 / 12.02	
	Conductor type	Type of conductor	solid 0.2 mm <sup>2</sup>
		and conductor cross-section	

**BLZP 5.08HC/03/90 SN OR BX**

**Weidmüller Interface GmbH & Co. KG**  
 Klingenbergstraße 26  
 D-32758 Detmold  
 Germany

www.weidmueller.com

**Technical data**

		Type of conductor and conductor cross-section	stranded 0.2 mm <sup>2</sup>	
		Type of conductor and conductor cross-section	solid 2.5 mm <sup>2</sup>	
		Type of conductor and conductor cross-section	stranded 2.5 mm <sup>2</sup>	
		Type of conductor and conductor cross-section	AWG 26/1	
		Type of conductor and conductor cross-section	AWG 26/19	
	Evaluation	passed		
Test for damage to and accidental loosening of conductors	Standard	DIN EN 60999-1 section 9.4 / 12.00		
	Requirement	0.2 kg		
	Conductor type	Type of conductor and conductor cross-section	AWG 26/1	
		Type of conductor and conductor cross-section	AWG 26/19	
	Evaluation	passed		
	Requirement	0.3 kg		
	Conductor type	Type of conductor and conductor cross-section	solid 0.5 mm <sup>2</sup>	
		Type of conductor and conductor cross-section	stranded 0.5 mm <sup>2</sup>	
	Evaluation	passed		
	Requirement	0.9 kg		
Pull-out test	Conductor type	Type of conductor and conductor cross-section	AWG 12/1	
		Type of conductor and conductor cross-section	AWG 12/19	
	Evaluation	passed		
	Standard	DIN EN 60999-1 section 9.5 / 12.00		
	Requirement	≥10 N		
	Conductor type	Type of conductor and conductor cross-section	AWG 26/1	
		Type of conductor and conductor cross-section	AWG 26/19	
	Evaluation	passed		
	Requirement	≥20 N		
	Conductor type	Type of conductor and conductor cross-section	H05V-U0.5	
Type of conductor and conductor cross-section		H05V-K0.5		
Evaluation	passed			
Requirement	≥60 N			
Conductor type	Type of conductor and conductor cross-section	H07V-U4.0		

**BLZP 5.08HC/03/90 SN OR BX**

**Weidmüller Interface GmbH & Co. KG**  
 Klingenbergstraße 26  
 D-32758 Detmold  
 Germany

www.weidmueller.com

**Technical data**

	Type of conductor and conductor cross-section	H07V-K4.0
	Type of conductor and conductor cross-section	AWG 12/1
	Type of conductor and conductor cross-section	AWG 12/19
Evaluation	passed	

**Important note**

IPC conformity	Conformity: The products are developed, manufactured and delivered according international recognized standards and norms and comply with the assured properties in the data sheet resp. fulfill decorative properties in accordance with IPC-A-610 "Class 2". Further claims on the products can be evaluated on request.
Notes	<ul style="list-style-type: none"> <li>• Additional variants on request</li> <li>• Gold-plated contact surfaces on request</li> <li>• Rated current related to rated cross-section &amp; min. No. of poles.</li> <li>• Wire end ferrule without plastic collar to DIN 46228/1</li> <li>• Wire end ferrule with plastic collar to DIN 46228/4</li> <li>• P on drawing = pitch</li> <li>• Rated data refer only to the component itself. Clearance and creepage distances to other components are to be designed in accordance with the relevant application standards.</li> <li>• In accordance with IEC 61984, OMNIMATE-connectors are connectors without breaking capacity (COC). During designated use, connectors are not allowed to be engaged or disengaged when live or under load</li> <li>• Long term storage of the product with average temperature of 50 °C and maximum humidity 70%, 36 months</li> </ul>

**Classifications**

ETIM 8.0	EC002638	ETIM 9.0	EC002638
ETIM 10.0	EC002638	ECLASS 14.0	27-46-02-02
ECLASS 15.0	27-46-02-02		

**BLZP 5.08HC/03/90 SN OR BX**

**Weidmüller Interface GmbH & Co. KG**  
Klingenbergstraße 26  
D-32758 Detmold  
Germany

Drawings

[www.weidmueller.com](http://www.weidmueller.com)

Product image

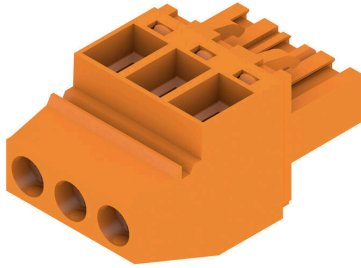

Dimensional drawing

