

BLZP 5.08HC/02/90 SN OR BX

Weidmüller Interface GmbH & Co. KG
 Klingenbergstraße 26
 D-32758 Detmold
 Germany

www.weidmueller.com

Product image

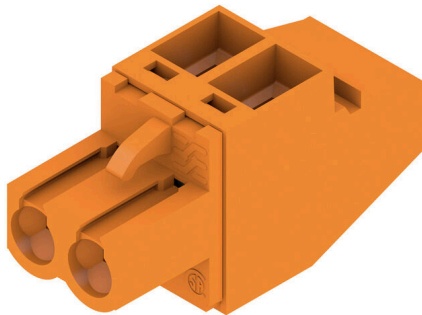

Female plugs with clamping-yoke connection for connecting wires with a right-angle (90° or 270°) outlet direction. The female connectors provide space for labelling and can be coded. Fastened by means of a flange or release latch. They also provide an integrated plus/minus screw, protection against faulty insertion of the wire, and they are delivered with open clamping yokes. HC = High Current.

General ordering data

Version	PCB plug-in connector, female plug, 5.08 mm, Number of poles: 2, 90°, Clamping yoke connection, Clamping range, max. : 4 mm ² , Box
Order No.	1948000000
Type	BLZP 5.08HC/02/90 SN OR BX
GTIN (EAN)	4032248624225
Qty.	180 items
Product data	IEC: 400 V / 23 A / 0.2 - 4 mm ² UL: 300 V / 20 A / AWG 26 - AWG 12
Packaging	Box

BLZP 5.08HC/02/90 SN OR BX

Weidmüller Interface GmbH & Co. KG
 Klingenbergstraße 26
 D-32758 Detmold
 Germany

www.weidmueller.com

Technical data

Approvals

Approvals



ROHS	Conform
UL File Number Search	UL Website
Certificate No. (cURus)	E60693

Dimensions and weights

Depth	27.2 mm	Depth (inches)	1.0709 inch
Height	14.1 mm	Height (inches)	0.5551 inch
Width	10.16 mm	Width (inches)	0.4 inch
Net weight	3.54 g		

Environmental Product Compliance

RoHS Compliance Status	Compliant without exemption		
REACH SVHC	No SVHC above 0.1 wt%		
Product Carbon Footprint	Cradle to gate	0,147 kg CO2 eq.	

System Parameters

Product family	OMNIMATE Signal - series BL/SL 5.08		
Type of connection	Field connection		
Wire connection method	Clamping yoke connection		
Pitch in mm (P)	5.08 mm		
Pitch in inches (P)	0.200 "		
Conductor outlet direction	90°		
Number of poles	2		
L1 in mm	5.08 mm		
L1 in inches	0.200 "		
Number of rows	1		
Pin series quantity	1		
Rated cross-section	4 mm ²		
Touch-safe protection acc. to DIN VDE 57 106	Safe from finger touch		
Touch-safe protection acc. to DIN VDE 0470	IP20 plugged/ IP10 unplugged		
Protection degree	IP20		
Volume resistance	≤5 mΩ		
Can be coded	Yes		
Stripping length	7 mm		
Clamping screw	M 2.5		
Screwdriver blade	0.6 x 3.5, PH 1, PZ 1		
Screwdriver blade standard	DIN 5264, ISO 8764/2-PH, ISO 8764/2-PZ		
Plugging cycles	25		
Plugging force/pole, max.	10 N		
Pulling force/pole, max.	9 N		
Tightening torque	Torque type	Wire connection	
	Usage information	Tightening torque	min. 0.4 Nm max. 0.5 Nm

BLZP 5.08HC/02/90 SN OR BX

Weidmüller Interface GmbH & Co. KG
 Klingenbergstraße 26
 D-32758 Detmold
 Germany

www.weidmueller.com

Technical data

Material data

Insulating material	PBT	Colour	orange
Colour chart (similar)	RAL 2000	Insulating material group	Illa
Comparative Tracking Index (CTI)	≥ 200	Moisture Level (MSL)	
UL 94 flammability rating	V-0	Contact material	Cu-alloy
Contact surface	tinned	Layer structure of plug contact	4...8 µm Sn hot-dip tinned
Storage temperature, min.	-40 °C	Storage temperature, max.	70 °C
Operating temperature, min.	-50 °C	Operating temperature, max.	100 °C
Temperature range, installation, min.	-25 °C	Temperature range, installation, max.	100 °C

Conductors suitable for connection

Clamping range, min.	0.13 mm ²
Clamping range, max.	4 mm ²
Wire connection cross section AWG, min.	AWG 30
Wire connection cross section AWG, max.	AWG 12
Solid, min. H05(07) V-U	0.2 mm ²
Solid, max. H05(07) V-U	4 mm ²
Flexible, min. H05(07) V-K	0.2 mm ²
Flexible, max. H05(07) V-K	4 mm ²
w. plastic collar ferrule, DIN 46228 pt 4, min.	0.2 mm ²
w. plastic collar ferrule, DIN 46228 pt 4, max.	2.5 mm ²
w. wire end ferrule, DIN 46228 pt 1, min.	0.2 mm ²
w. wire end ferrule, DIN 46228 pt 1, max.	4 mm ²
Plug gauge in accordance with EN 60999 a x b; ø	2.8 mm x 2.4 mm

Clampable conductor	Cross-section for conductor connection wire end ferrule	nominal	0.5 mm ²
		Stripping length	nominal 6 mm
		Recommended wire-end ferrule	H0,5/6
		Stripping length	nominal 8 mm
	Cross-section for conductor connection wire end ferrule	nominal	1 mm ²
		Stripping length	nominal 6 mm
		Recommended wire-end ferrule	H1,0/6
		Stripping length	nominal 8 mm
	Cross-section for conductor connection wire end ferrule	nominal	1.5 mm ²
		Stripping length	nominal 7 mm
		Recommended wire-end ferrule	H1,5/7
		Stripping length	nominal 10 mm
	Cross-section for conductor connection wire end ferrule	nominal	2.5 mm ²
		Stripping length	nominal 7 mm
		Recommended wire-end ferrule	H2,5/7
		Stripping length	nominal 10 mm
	Cross-section for conductor connection wire end ferrule	nominal	2.5 mm ²
		Stripping length	nominal 7 mm
		Recommended wire-end ferrule	H2,5/7
		Stripping length	nominal 10 mm
Cross-section for conductor connection wire end ferrule	nominal	2.5 mm ²	
	Stripping length	nominal 7 mm	
	Recommended wire-end ferrule	H2,5/7	
	Stripping length	nominal 10 mm	

Reference text The outside diameter of the plastic collar should not be larger than the pitch (P). Length of ferrules is to be chosen depending on the product and the rated voltage.

BLZP 5.08HC/02/90 SN OR BX

Weidmüller Interface GmbH & Co. KG
 Klingenbergstraße 26
 D-32758 Detmold
 Germany

www.weidmueller.com

Technical data

Rated data acc. to IEC

tested acc. to standard	IEC 60664-1, IEC 61984	Rated current, min. number of poles (Tu=20°C)	23 A
Rated current, max. number of poles (Tu=20°C)	18 A	Rated current, min. number of poles (Tu=40°C)	21 A
Rated current, max. number of poles (Tu=40°C)	16 A	Rated voltage for surge voltage class / pollution degree II/2	400 V
Rated voltage for surge voltage class / pollution degree III/2	320 V	Rated voltage for surge voltage class / pollution degree III/3	250 V
Rated impulse voltage for surge voltage class/ pollution degree II/2	4 kV	Rated impulse voltage for surge voltage class/ pollution degree III/2	4 kV
Rated impulse voltage for surge voltage class/ contamination degree III/3	4 kV	Short-time withstand current resistance	3 x 1s with 120 A

Rated data acc. to CSA

Institute (CSA)	CSA	Certificate No. (CSA)	200039-1121690
Rated voltage (Use group B / CSA)	300 V	Rated voltage (Use group C / CSA)	50 V
Rated voltage (Use group D / CSA)	300 V	Rated current (Use group B / CSA)	20 A
Rated current (Use group D / CSA)	20 A	Wire cross-section, AWG, min.	AWG 30
Wire cross-section, AWG, max.	AWG 12	Reference to approval values	Specifications are maximum values, details - see approval certificate.

Rated data acc. to UL 1059

Institute (cURus)	CURUS	Certificate No. (cURus)	E60693
Rated voltage (Use group B / UL 1059)	300 V	Rated voltage (Use group D / UL 1059)	300 V
Rated current (Use group B / UL 1059)	20 A	Rated current (Use group D / UL 1059)	10 A
Wire cross-section, AWG, min.	AWG 26	Wire cross-section, AWG, max.	AWG 12
Reference to approval values	Specifications are maximum values, details - see approval certificate.		

Packing

Packaging	Box	VPE length	349.00 mm
VPE width	138.00 mm	VPE height	32.00 mm

Type tests

Test: Durability of markings	Standard	DIN EN 61984 section 7.3.2 / 09.02 taking pattern from DIN EN 60068-2-70 / 07.96	
	Test	mark of origin, rated voltage, rated cross-section, type of material	
	Evaluation	available	
	Test	durability	
Test: Misengagement (Non-interchangeability)	Evaluation	passed	
	Standard	DIN EN 60512-13-5 / 11.06, IEC 60512-13-5 / 02.06	
	Test	180° turned with coding elements	
	Evaluation	passed	
Test: Clampable cross section	Test	visual examination	
	Evaluation	passed	
	Standard	DIN EN 60999-1 section 7 and 9.1 / 12.00, DIN EN 60947-1 section 8.2.4.5.1 / 12.02	
	Conductor type	Type of conductor	solid 0.2 mm ² and conductor cross-section

BLZP 5.08HC/02/90 SN OR BX

Weidmüller Interface GmbH & Co. KG
 Klingenbergstraße 26
 D-32758 Detmold
 Germany

www.weidmueller.com

Technical data

		Type of conductor and conductor cross-section	stranded 0.2 mm ²	
		Type of conductor and conductor cross-section	solid 2.5 mm ²	
		Type of conductor and conductor cross-section	stranded 2.5 mm ²	
		Type of conductor and conductor cross-section	AWG 26/1	
		Type of conductor and conductor cross-section	AWG 26/19	
	Evaluation	passed		
Test for damage to and accidental loosening of conductors	Standard	DIN EN 60999-1 section 9.4 / 12.00		
	Requirement	0.2 kg		
	Conductor type	Type of conductor and conductor cross-section	AWG 26/1	
		Type of conductor and conductor cross-section	AWG 26/19	
	Evaluation	passed		
	Requirement	0.3 kg		
	Conductor type	Type of conductor and conductor cross-section	solid 0.5 mm ²	
		Type of conductor and conductor cross-section	stranded 0.5 mm ²	
	Evaluation	passed		
	Requirement	0.9 kg		
Pull-out test	Conductor type	Type of conductor and conductor cross-section	AWG 12/1	
		Type of conductor and conductor cross-section	AWG 12/19	
	Evaluation	passed		
	Standard	DIN EN 60999-1 section 9.5 / 12.00		
	Requirement	≥10 N		
	Conductor type	Type of conductor and conductor cross-section	AWG 26/1	
		Type of conductor and conductor cross-section	AWG 26/19	
	Evaluation	passed		
	Requirement	≥20 N		
	Conductor type	Type of conductor and conductor cross-section	H05V-U0.5	
Type of conductor and conductor cross-section		H05V-K0.5		
Evaluation	passed			
Requirement	≥60 N			
Conductor type	Type of conductor and conductor cross-section	H07V-U4.0		

Technical data

	Type of conductor and conductor cross-section	H07V-K4.0
	Type of conductor and conductor cross-section	AWG 12/1
	Type of conductor and conductor cross-section	AWG 12/19
Evaluation	passed	

Important note

IPC conformity	Conformity: The products are developed, manufactured and delivered according international recognized standards and norms and comply with the assured properties in the data sheet resp. fulfill decorative properties in accordance with IPC-A-610 "Class 2". Further claims on the products can be evaluated on request.
Notes	<ul style="list-style-type: none"> • Additional variants on request • Gold-plated contact surfaces on request • Rated current related to rated cross-section & min. No. of poles. • Wire end ferrule without plastic collar to DIN 46228/1 • Wire end ferrule with plastic collar to DIN 46228/4 • P on drawing = pitch • Rated data refer only to the component itself. Clearance and creepage distances to other components are to be designed in accordance with the relevant application standards. • In accordance with IEC 61984, OMNIMATE-connectors are connectors without breaking capacity (COC). During designated use, connectors are not allowed to be engaged or disengaged when live or under load • Long term storage of the product with average temperature of 50 °C and maximum humidity 70%, 36 months

Classifications

ETIM 8.0	EC002638	ETIM 9.0	EC002638
ETIM 10.0	EC002638	ECLASS 14.0	27-46-02-02
ECLASS 15.0	27-46-02-02		

Product image

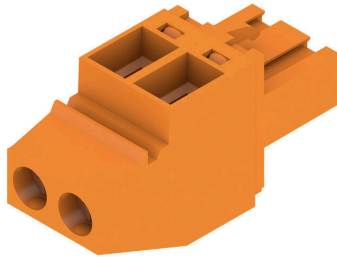

Dimensional drawing



BLZP 5.08HC/02/90 SN OR BX

Weidmüller Interface GmbH & Co. KG
 Klingenbergstraße 26
 D-32758 Detmold
 Germany

www.weidmueller.com

Accessories

Coding elements



Only connects what is supposed to be connected: the right connection at the right place.
 Coding elements and locking devices clearly assign connecting elements during the manufacturing process and operation
 The coding elements and locking devices are inserted prior to assembly or during the cable assembly phase.
 The Weidmüller alternative: configure online using the variant configurator to precode prior to delivery.
 Incorrect assembly on the circuit board and incorrect plugging of connecting elements is no longer possible.
 The advantage: no troubleshooting during manufacture and no operational errors by the user.

General ordering data

Type	BLZ/SL KO OR BX	Version
Order No.	1573010000	PCB plug-in connector, Accessories, Coding element, orange, Number
GTIN (EAN)	4008190048396	of poles: 1
Qty.	100 ST	
Type	BLZ/SL KO BK BX	Version
Order No.	1545710000	PCB plug-in connector, Accessories, Coding element, black, Number
GTIN (EAN)	4008190087142	of poles: 1
Qty.	50 ST	

Slotted screwdriver



Slotted screwdriver with rounded blade SD DIN 5265, ISO 2380/2, output to DIN 5264, ISO 2380/1.
 ChromTop tip, SoftFinish grip

General ordering data

Type	SDS 0.6X3.5X100	Version
Order No.	2749340000	Screwdriver, Blade width (B): 3.5 mm, Blade length: 100 mm, Blade
GTIN (EAN)	4050118895568	thickness (A): 0.6 mm
Qty.	1 ST	
Type	SDIS 0.6X3.5X100	Version
Order No.	2749810000	Screwdriver, Blade width (B): 3.5 mm, Blade length: 100 mm, Blade
GTIN (EAN)	4050118897012	thickness (A): 0.6 mm
Qty.	1 ST	

BLZP 5.08HC/02/90 SN OR BX

Weidmüller Interface GmbH & Co. KG
 Klingenbergstraße 26
 D-32758 Detmold
 Germany

www.weidmueller.com

Accessories
Crosshead screwdriver Phillips

Crosshead screwdriver, Phillips, SDK PH DIN 5262, ISO 8764/2-PH, output to ISO 8764-PH, ChromTop tip, SoftFinish grip

General ordering data

Type	SDK PH1 X 80	Version	
Order No.	2749410000	Screwdriver, Blade width (B): 4.5 mm, 80 mm, Blade thickness (A): 1	
GTIN (EAN)	4050118895636		
Qty.	1 ST		

Crosshead screwdriver Pozidriv

Crosshead screwdriver, Pozidriv, SDK PZ DIN 5262, ISO 8764/2-PZ, output to ISO 8764/1-PZ, ChromTop tip, SoftFinish grip

General ordering data

Type	SDK PZ1 X 80	Version	
Order No.	2749440000	Screwdriver, Blade width (B): 14.5 mm, 80 mm, Blade thickness (A): 1	
GTIN (EAN)	4050118895667		
Qty.	1 ST		

BLZP 5.08HC/02/90 SN OR BX

Weidmüller Interface GmbH & Co. KG
 Klingenbergstraße 26
 D-32758 Detmold
 Germany

www.weidmueller.com

Counterpart

SLDF 5.08



Male connector for through-panel mounting with optional locking function. Internal connection as flat-blade or solder connection. These male connectors provide space for labelling and can be coded.

General ordering data

Type	SLDF 5.08 L/F 2 SN BK BX	Version	
Order No.	1635740000	PCB plug-in connector, male header, 5.08 mm, Number of poles: 2,	
GTIN (EAN)	4008190264161	180°, Flat-blade connection, Solder connection, Box	
Qty.	60 ST		
Type	SLDF 5.08 L/F 2 SN OR BX	Version	
Order No.	1599130000	PCB plug-in connector, male header, 5.08 mm, Number of poles: 2,	
GTIN (EAN)	4008190175931	180°, Flat-blade connection, Solder connection, Box	
Qty.	60 ST		

SL 5.08/135



Male connectors with 135° outlet direction. The solder pin length is optimised for wave flow soldering. The pin headers provide space for labelling and can be coded.

General ordering data

Type	SL 5.08/02/135 3.2SN OR...	Version	
Order No.	1603060000	PCB plug-in connector, male header, open side, THT solder	
GTIN (EAN)	4008190095512	connection, 5.08 mm, Number of poles: 2, 135°, Solder pin length (l):	
Qty.	100 ST	3.2 mm, tinned, orange, Box	

SL 5.08/135B



Male connectors with 135° outlet direction. The solder pin length is optimised for wave flow soldering. The pin headers provide space for labelling and can be coded.

BLZP 5.08HC/02/90 SN OR BX

Weidmüller Interface GmbH & Co. KG
 Klingenbergstraße 26
 D-32758 Detmold
 Germany

www.weidmueller.com

Counterpart

General ordering data

Type	SL 5.08/02/135B 3.2SN O...	Version
Order No.	1605530000	PCB plug-in connector, male header, Dovetails for fixing blocks, THT
GTIN (EAN)	4008190104290	solder connection, 5.08 mm, Number of poles: 2, 135°, Solder pin
Qty.	100 ST	length (l): 3.2 mm, tinned, orange, Box

SL 5.08/180



Male connectors with straight outlet direction. The solder pin length is optimised for wave flow soldering. The pin headers provide space for labelling and can be coded.

General ordering data

Type	SL 5.08/02/180 3.2SN OR...	Version
Order No.	1517260000	PCB plug-in connector, male header, open side, THT solder
GTIN (EAN)	4008190034795	connection, 5.08 mm, Number of poles: 2, 180°, Solder pin length (l):
Qty.	100 ST	3.2 mm, tinned, orange, Box

SL 5.08/180B



Male connectors with straight outlet direction. The solder pin length is optimised for wave flow soldering. The pin headers provide space for labelling and can be coded.

General ordering data

Type	SL 5.08/02/180B 3.2SN O...	Version
Order No.	1519560000	PCB plug-in connector, male header, Dovetails for fixing blocks, THT
GTIN (EAN)	4008190083892	solder connection, 5.08 mm, Number of poles: 2, 180°, Solder pin
Qty.	100 ST	length (l): 3.2 mm, tinned, orange, Box

BLZP 5.08HC/02/90 SN OR BX

Weidmüller Interface GmbH & Co. KG
Klingenbergstraße 26
D-32758 Detmold
Germany

www.weidmueller.com

Counterpart

SL 5.08/90



Male connectors with 90° outlet direction. The solder pin length is optimised for wave flow soldering. The pin headers provide space for labelling and can be coded.

General ordering data

Type	SL 5.08/02/90 3.2SN OR ...	Version
Order No.	1508060000	PCB plug-in connector, male header, open side, THT solder
GTIN (EAN)	4008190189006	connection, 5.08 mm, Number of poles: 2, 90°, Solder pin length (l):
Qty.	100 ST	3.2 mm, tinned, orange, Box

SL 5.08/90B



Male connectors with 90° outlet direction. The solder pin length is optimised for wave flow soldering. The pin headers provide space for labelling and can be coded.

General ordering data

Type	SL 5.08/02/90B 3.2SN BK...	Version
Order No.	1510310000	PCB plug-in connector, male header, Dovetails for fixing blocks, THT
GTIN (EAN)	4008190477684	solder connection, 5.08 mm, Number of poles: 2, 90°, Solder pin
Qty.	100 ST	length (l): 3.2 mm, tinned, black, Box
Type	SL 5.08/02/90B 3.2SN OR...	Version
Order No.	1510360000	PCB plug-in connector, male header, Dovetails for fixing blocks, THT
GTIN (EAN)	4008190180188	solder connection, 5.08 mm, Number of poles: 2, 90°, Solder pin
Qty.	100 ST	length (l): 3.2 mm, tinned, orange, Box

SL 5.08HC/180



Pin headers in glass-fibre-reinforced plastic with straight wire outlet; optimised for wave soldering. The flange variant (F) can be screwed onto the respective counter piece or the circuit board. There is no need for an extra screw to connect the circuit board when the solder flange (LF) version is used. This also protects the solder points from mechanical strain. All pin headers can be manually coded or ordered pre-coded. HC = High Current.

BLZP 5.08HC/02/90 SN OR BX

Weidmüller Interface GmbH & Co. KG
Klingenbergstraße 26
D-32758 Detmold
Germany

www.weidmueller.com

Counterpart

General ordering data

Type	SL 5.08HC/02/180 3.2SN ...	Version
Order No.	1148080000	PCB plug-in connector, male header, open side, THT solder
GTIN (EAN)	4032248934386	connection, 5.08 mm, Number of poles: 2, 180°, Solder pin length (l):
Qty.	100 ST	3.2 mm, tinned, black, Box
Type	SL 5.08HC/02/180 3.2SN ...	Version
Order No.	1146320000	PCB plug-in connector, male header, open side, THT solder
GTIN (EAN)	4032248108916	connection, 5.08 mm, Number of poles: 2, 180°, Solder pin length (l):
Qty.	100 ST	3.2 mm, tinned, orange, Box

SL 5.08HC/180B



Pin headers in glass-fibre-reinforced plastic with straight wire outlet; optimised for wave soldering. The flange variant (F) can be screwed onto the respective counter piece or the circuit board. There is no need for an extra screw to connect the circuit board when the solder flange (LF) version is used. This also protects the solder points from mechanical strain. All pin headers can be manually coded or ordered pre-coded. HC = High Current.

General ordering data

Type	SL 5.08HC/02/180B 3.2SN...	Version
Order No.	1149400000	PCB plug-in connector, male header, Dovetails for fixing blocks, THT
GTIN (EAN)	4032248934669	solder connection, 5.08 mm, Number of poles: 2, 180°, Solder pin
Qty.	100 ST	length (l): 3.2 mm, tinned, black, Box
Type	SL 5.08HC/02/180B 3.2SN...	Version
Order No.	1147300000	PCB plug-in connector, male header, Dovetails for fixing blocks, THT
GTIN (EAN)	4032248933839	solder connection, 5.08 mm, Number of poles: 2, 180°, Solder pin
Qty.	100 ST	length (l): 3.2 mm, tinned, orange, Box

SL 5.08HC/180G



Pin headers in glass-fibre-reinforced plastic with straight wire outlet; optimised for wave soldering. The flange variant (F) can be screwed onto the respective counter piece or the circuit board. There is no need for an extra screw to connect the circuit board when the solder flange (LF) version is used. This also protects the solder points from mechanical strain. All pin headers can be manually coded or ordered pre-coded. HC = High Current.

General ordering data

Type	SL 5.08HC/02/180G 3.2SN...	Version
Order No.	1148630000	PCB plug-in connector, male header, closed side, THT solder
GTIN (EAN)	4032248934409	connection, 5.08 mm, Number of poles: 2, 180°, Solder pin length (l):
Qty.	100 ST	3.2 mm, tinned, black, Box
Type	SL 5.08HC/02/180G 3.2SN...	Version
Order No.	1146730000	PCB plug-in connector, male header, closed side, THT solder
GTIN (EAN)	4032248108688	connection, 5.08 mm, Number of poles: 2, 180°, Solder pin length (l):
Qty.	100 ST	3.2 mm, tinned, orange, Box

BLZP 5.08HC/02/90 SN OR BX

Weidmüller Interface GmbH & Co. KG
 Klingenbergstraße 26
 D-32758 Detmold
 Germany

Counterpart

www.weidmueller.com

SL 5.08HC/90



Pin headers made from glass-fibre-reinforced plastic with 90° wire outlet; optimised for wave soldering. The flange variant (F) can be screwed onto the respective counter piece or the circuit board. There is no need for an extra screw to connect the circuit board when the solder flange (LF) version is used. This also protects the solder points from mechanical strain. All pin headers can be manually coded or ordered pre-coded. HC = High Current.

General ordering data

Type	SL 5.08HC/02/90 3.2SN B...	Version
Order No.	1155030000	PCB plug-in connector, male header, open side, THT solder
GTIN (EAN)	4050118050813	connection, 5.08 mm, Number of poles: 2, 90°, Solder pin length (l):
Qty.	100 ST	3.2 mm, tinned, black, Box
Type	SL 5.08HC/02/90 3.2SN O...	Version
Order No.	1146720000	PCB plug-in connector, male header, open side, THT solder
GTIN (EAN)	4050118051506	connection, 5.08 mm, Number of poles: 2, 90°, Solder pin length (l):
Qty.	100 ST	3.2 mm, tinned, orange, Box

SL 5.08HC/90B

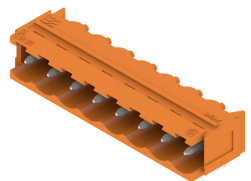

Pin headers made from glass-fibre-reinforced plastic with 90° wire outlet; optimised for wave soldering. The flange variant (F) can be screwed onto the respective counter piece or the circuit board. There is no need for an extra screw to connect the circuit board when the solder flange (LF) version is used. This also protects the solder points from mechanical strain. All pin headers can be manually coded or ordered pre-coded. HC = High Current.

General ordering data

Type	SL 5.08HC/02/90B 3.2SN ...	Version
Order No.	1155580000	PCB plug-in connector, male header, Dovetails for fixing blocks, THT
GTIN (EAN)	4050118050356	solder connection, 5.08 mm, Number of poles: 2, 90°, Solder pin
Qty.	100 ST	length (l): 3.2 mm, tinned, black, Box
Type	SL 5.08HC/02/90B 3.2SN ...	Version
Order No.	1148030000	PCB plug-in connector, male header, Dovetails for fixing blocks, THT
GTIN (EAN)	4050118051049	solder connection, 5.08 mm, Number of poles: 2, 90°, Solder pin
Qty.	100 ST	length (l): 3.2 mm, tinned, orange, Box

BLZP 5.08HC/02/90 SN OR BX

Weidmüller Interface GmbH & Co. KG
Klingenbergstraße 26
D-32758 Detmold
Germany

www.weidmueller.com

Counterpart

SLDV 5.08/180



Pin headers with solder pin length optimised for wave flow soldering. The male connectors provide space for labelling and can be coded. HC = High Current.

General ordering data

Type	SLD 5.08V/04/180 3.2SN ...	Version
Order No.	1725650000	PCB plug-in connector, male header, open side, THT solder
GTIN (EAN)	4032248061945	connection, 5.08 mm, Number of poles: 4, 180°, Solder pin length (l):
Qty.	50 ST	3.2 mm, tinned, orange, Box

SLDV 5.08/180B



Pin headers with solder pin length optimised for wave flow soldering. The male connectors provide space for labelling and can be coded. HC = High Current.

General ordering data

Type	SLD 5.08V/04/180B 3.2SN...	Version
Order No.	1726740000	PCB plug-in connector, male header, Dovetails for fixing blocks, THT
GTIN (EAN)	4032248062621	solder connection, 5.08 mm, Number of poles: 4, 180°, Solder pin
Qty.	50 ST	length (l): 3.2 mm, tinned, orange, Box

SLDV 5.08/90



Pin headers with solder pin length optimised for wave flow soldering. The male connectors provide space for labelling and can be coded. HC = High Current.

General ordering data

Type	SLD 5.08V/04/90 3.2 SN ...	Version
Order No.	1725170000	PCB plug-in connector, male header, open side, THT solder
GTIN (EAN)	4032248060573	connection, 5.08 mm, Number of poles: 4, 90°, Solder pin length (l):
Qty.	50 ST	3.2 mm, tinned, orange, Box

BLZP 5.08HC/02/90 SN OR BX

Weidmüller Interface GmbH & Co. KG
 Klingenbergstraße 26
 D-32758 Detmold
 Germany

www.weidmueller.com

Counterpart

SLDV 5.08/90B



Pin headers with solder pin length optimised for wave flow soldering. The male connectors provide space for labelling and can be coded. HC = High Current.

General ordering data

Type	SLD 5.08V/04/90B 3.2 SN...	Version
Order No.	1726280000	PCB plug-in connector, male header, Dovetails for fixing blocks, THT
GTIN (EAN)	4032248061259	solder connection, 5.08 mm, Number of poles: 4, 90°, Solder pin
Qty.	50 ST	length (l): 3.2 mm, tinned, orange, Box

SL-SMT 5.08/180 Box



High-temperature-resistant, straight, open pin header. Packed in box or tape. On tape and with 1.5 mm solder pin, optimised for automatic assembly. 3.2 mm solder pin suitable for reflow and wave soldering. The pin headers provide space for labelling and can be coded. HC = High Current.

General ordering data

Type	SL-SMT 5.08HC/02/180 1....	Version
Order No.	1775522001	PCB plug-in connector, male header, open side, THT/THR solder
GTIN (EAN)	4032248157549	connection, 5.08 mm, Number of poles: 2, 180°, Solder pin length (l):
Qty.	100 ST	1.5 mm, tinned, black, Box
Type	SL-SMT 5.08HC/02/180 3....	Version
Order No.	1837980000	PCB plug-in connector, male header, open side, THT/THR solder
GTIN (EAN)	4032248348046	connection, 5.08 mm, Number of poles: 2, 180°, Solder pin length (l):
Qty.	100 ST	3.2 mm, tinned, black, Box

SL-SMT 5.08/180 Tape



High-temperature-resistant, straight, open pin header. Packed in box or tape. On tape and with 1.5 mm solder pin, optimised for automatic assembly. 3.2 mm solder pin suitable for reflow and wave soldering. The pin headers provide space for labelling and can be coded. HC = High Current.

BLZP 5.08HC/02/90 SN OR BX

Weidmüller Interface GmbH & Co. KG
 Klingenbergstraße 26
 D-32758 Detmold
 Germany

www.weidmueller.com

Counterpart**General ordering data**

Type	SL-SMT 5.08HC/02/180 1...	Version
Order No.	1821100000	PCB plug-in connector, male header, open side, THT/THR solder
GTIN (EAN)	4032248319749	connection, 5.08 mm, Number of poles: 2, 180°, Solder pin length (l):
Qty.	250 ST	1.5 mm, tinned, black, Tape

SL-SMT 5.08/180G Box

High-temperature-resistant pin header, packed in box or tape. On tape, with 1.5 mm solder pin, optimised for automatic assembly. 3.2 mm solder pin suitable for reflow and wave soldering. The pin headers provide space for labelling and can be coded. HC = High Current.

General ordering data

Type	SL-SMT 5.08HC/02/180G 1...	Version
Order No.	1775922001	PCB plug-in connector, male header, closed side, THT/THR solder
GTIN (EAN)	4032248158911	connection, 5.08 mm, Number of poles: 2, 180°, Solder pin length (l):
Qty.	100 ST	1.5 mm, tinned, black, Box
Type	SL-SMT 5.08HC/02/180G 3...	Version
Order No.	1838210000	PCB plug-in connector, male header, closed side, THT/THR solder
GTIN (EAN)	4032248348275	connection, 5.08 mm, Number of poles: 2, 180°, Solder pin length (l):
Qty.	100 ST	3.2 mm, tinned, black, Box

SL-SMT 5.08/180G Tape

High-temperature-resistant pin header, packed in box or tape. On tape, with 1.5 mm solder pin, optimised for automatic assembly. 3.2 mm solder pin suitable for reflow and wave soldering. The pin headers provide space for labelling and can be coded. HC = High Current.

General ordering data

Type	SL-SMT 5.08HC/02/180G 1...	Version
Order No.	1820170000	PCB plug-in connector, male header, closed side, THT/THR solder
GTIN (EAN)	4032248315680	connection, 5.08 mm, Number of poles: 2, 180°, Solder pin length (l):
Qty.	250 ST	1.5 mm, tinned, black, Tape

BLZP 5.08HC/02/90 SN OR BX

Weidmüller Interface GmbH & Co. KG
Klingenbergstraße 26
D-32758 Detmold
Germany

Counterpart

www.weidmueller.com

SL-SMT 5.08/270GH Box



High-temperature-resistant, straight, open pin header. Packed in box or tape. On tape and with 1.5 mm solder pin, optimised for automatic assembly. 3.2 mm solder pin suitable for reflow and wave soldering. The pin headers provide space for labelling and can be coded. HC = High Current.

General ordering data

Type	SL-SMT 5.08HC/02/270GH ...	Version
Order No.	1876340000	PCB plug-in connector, male header, closed side, THT/THR solder connection, 5.08 mm, Number of poles: 2, 270°, Solder pin length (l):
GTIN (EAN)	4032248466818	
Qty.	100 ST	1.5 mm, tinned, black, Box
Type	SL-SMT 5.08HC/02/270GH ...	Version
Order No.	1877370000	PCB plug-in connector, male header, closed side, THT/THR solder connection, 5.08 mm, Number of poles: 2, 270°, Solder pin length (l):
GTIN (EAN)	4032248468003	
Qty.	100 ST	3.2 mm, tinned, black, Box

SL-SMT 5.08/270GH Tape



High-temperature-resistant, straight, open pin header. Packed in box or tape. On tape and with 1.5 mm solder pin, optimised for automatic assembly. 3.2 mm solder pin suitable for reflow and wave soldering. The pin headers provide space for labelling and can be coded. HC = High Current.

General ordering data

Type	SL-SMT 5.08HC/02/270GH ...	Version
Order No.	1877560000	PCB plug-in connector, male header, closed side, THT/THR solder connection, 5.08 mm, Number of poles: 2, 270°, Solder pin length (l):
GTIN (EAN)	4032248468188	
Qty.	335 ST	1.5 mm, tinned, black, Tape
Type	SL-SMT 5.08HC/02/270GH ...	Version
Order No.	1877810000	PCB plug-in connector, male header, closed side, THT/THR solder connection, 5.08 mm, Number of poles: 2, 270°, Solder pin length (l):
GTIN (EAN)	4032248468461	
Qty.	335 ST	3.2 mm, tinned, black, Tape

BLZP 5.08HC/02/90 SN OR BX

Weidmüller Interface GmbH & Co. KG
Klingenbergstraße 26
D-32758 Detmold
Germany

Counterpart

www.weidmueller.com

SL-SMT 5.08/270GL Box



High-temperature-resistant, straight, open pin header. Packed in box or tape. On tape and with 1.5 mm solder pin, optimised for automatic assembly. 3.2 mm solder pin suitable for reflow and wave soldering. The pin headers provide space for labelling and can be coded. HC = High Current.

General ordering data

Type	SL-SMT 5.08HC/02/270GL ...	Version
Order No.	1877100000	PCB plug-in connector, male header, closed side, THT/THR solder connection, 5.08 mm, Number of poles: 2, 270°, Solder pin length (l):
GTIN (EAN)	4032248467570	
Qty.	100 ST	1.5 mm, tinned, black, Box
Type	SL-SMT 5.08HC/02/270GL ...	Version
Order No.	1877470000	PCB plug-in connector, male header, closed side, THT/THR solder connection, 5.08 mm, Number of poles: 2, 270°, Solder pin length (l):
GTIN (EAN)	4032248468096	
Qty.	100 ST	3.2 mm, tinned, black, Box

SL-SMT 5.08/270GL Tape



High-temperature-resistant, straight, open pin header. Packed in box or tape. On tape and with 1.5 mm solder pin, optimised for automatic assembly. 3.2 mm solder pin suitable for reflow and wave soldering. The pin headers provide space for labelling and can be coded. HC = High Current.

General ordering data

Type	SL-SMT 5.08HC/02/270GL ...	Version
Order No.	1877400000	PCB plug-in connector, male header, closed side, THT/THR solder connection, 5.08 mm, Number of poles: 2, 270°, Solder pin length (l):
GTIN (EAN)	4032248467891	
Qty.	350 ST	1.5 mm, tinned, black, Tape

SL-SMT 5.08HC/90 Box



High-temperature-resistant, 90° angled, open male header. Packed in box or tape. On tape, with 1.5 mm solder pin, optimised for automatic assembly. 3.2 mm solder pin suitable for reflow and wave soldering. The pin headers provide space for labelling and can be coded. HC = High Current.

BLZP 5.08HC/02/90 SN OR BX

Weidmüller Interface GmbH & Co. KG
 Klingenbergstraße 26
 D-32758 Detmold
 Germany

www.weidmueller.com

Counterpart

General ordering data

Type	SL-SMT 5.08HC/02/90 1.5...	Version
Order No.	1774762001	PCB plug-in connector, male header, open side, THT/THR solder connection, 5.08 mm, Number of poles: 2, 90°, Solder pin length (l):
GTIN (EAN)	4032248155699	1.5 mm, tinned, black, Box
Qty.	100 ST	
Type	SL-SMT 5.08HC/02/90 3.2...	Version
Order No.	1779950000	PCB plug-in connector, male header, open side, THT/THR solder connection, 5.08 mm, Number of poles: 2, 90°, Solder pin length (l):
GTIN (EAN)	4032248165278	3.2 mm, tinned, black, Box
Qty.	100 ST	

SL-SMT 5.08HC/90 Tape



High-temperature-resistant, 90° angled, open male header. Packed in box or tape. On tape, with 1.5 mm solder pin, optimised for automatic assembly. 3.2 mm solder pin suitable for reflow and wave soldering. The pin headers provide space for labelling and can be coded. HC = High Current.

General ordering data

Type	SL-SMT 5.08HC/02/90 1.5...	Version
Order No.	1821160000	PCB plug-in connector, male header, open side, THT/THR solder connection, 5.08 mm, Number of poles: 2, 90°, Solder pin length (l):
GTIN (EAN)	4032248319800	1.5 mm, tinned, black, Tape
Qty.	350 ST	

SL-SMT 5.08HC/90G Box



High-temperature-resistant pin header, packed in box or tape. On tape, with 1.5 mm solder pin, optimised for automatic assembly. 3.2 mm solder pin suitable for reflow and wave soldering. The pin headers provide space for labelling and can be coded. HC = High Current.

General ordering data

Type	SL-SMT 5.08HC/02/90G 1....	Version
Order No.	1775002001	PCB plug-in connector, male header, closed side, THT/THR solder connection, 5.08 mm, Number of poles: 2, 90°, Solder pin length (l):
GTIN (EAN)	4032248156023	1.5 mm, tinned, black, Box
Qty.	100 ST	
Type	SL-SMT 5.08HC/02/90G 3....	Version
Order No.	1780180000	PCB plug-in connector, male header, closed side, THT/THR solder connection, 5.08 mm, Number of poles: 2, 90°, Solder pin length (l):
GTIN (EAN)	4032248165506	3.2 mm, tinned, black, Box
Qty.	100 ST	

BLZP 5.08HC/02/90 SN OR BX

Weidmüller Interface GmbH & Co. KG
Klingenbergstraße 26
D-32758 Detmold
Germany

www.weidmueller.com

Counterpart

SL-SMT 5.08HC/90G Tape



High-temperature-resistant pin header, packed in box or tape. On tape, with 1.5 mm solder pin, optimised for automatic assembly. 3.2 mm solder pin suitable for reflow and wave soldering. The pin headers provide space for labelling and can be coded. HC = High Current.

General ordering data

Type	SL-SMT 5.08HC/02/90G 1...	Version
Order No.	1821140000	PCB plug-in connector, male header, closed side, THT/THR solder connection, 5.08 mm, Number of poles: 2, 90°, Solder pin length (l):
GTIN (EAN)	4032248319787	
Qty.	350 ST	1.5 mm, tinned, black, Tape

SLF 5.08/180 SN

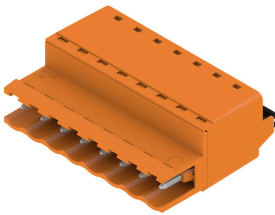

Male plug with PUSH IN wire connection and straight outlet direction, when used with BLF 5.08HC as wire-to-wire application for panel feed-through. The male plugs provide space for labelling and can be coded.

General ordering data

Type	SLF 5.08/02/180 SN BK BX	Version
Order No.	1335560000	PCB plug-in connector, male plug, 5.08 mm, Number of poles: 2,
GTIN (EAN)	4050118138740	180°, PUSH IN with actuator, Clamping range, max. : 3.31 mm ² , Box
Qty.	180 ST	
Type	SLF 5.08/02/180 SN OR BX	Version
Order No.	1335330000	PCB plug-in connector, male plug, 5.08 mm, Number of poles: 2,
GTIN (EAN)	4050118138559	180°, PUSH IN with actuator, Clamping range, max. : 3.31 mm ² , Box
Qty.	180 ST	

SLF 5.08/180B SN



Male plug with PUSH IN wire connection and straight outlet direction, when used with BLF 5.08HC as wire-to-wire application for panel feed-through. The male plugs provide space for labelling and can be coded.

BLZP 5.08HC/02/90 SN OR BX

Weidmüller Interface GmbH & Co. KG
 Klingenbergstraße 26
 D-32758 Detmold
 Germany

www.weidmueller.com

Counterpart

General ordering data

Type	SLF 5.08/02/180B SN BK ...	Version
Order No.	1335770000	PCB plug-in connector, male plug, 5.08 mm, Number of poles: 2,
GTIN (EAN)	4050118140590	180°, PUSH IN with actuator, Clamping range, max. : 3.31 mm², Box
Qty.	150 ST	
Type	SLF 5.08/02/180B SN OR ...	Version
Order No.	1335440000	PCB plug-in connector, male plug, 5.08 mm, Number of poles: 2,
GTIN (EAN)	4050118138832	180°, PUSH IN with actuator, Clamping range, max. : 3.31 mm², Box
Qty.	150 ST	

SLF 5.08/180DF SN



Male plug with PUSH IN wire connection and straight outlet direction, when used with BLF 5.08HC as wire-to-wire application for panel feed-through. The male plugs provide space for labelling and can be coded.

General ordering data

Type	SLF 5.08/02/180DF SN OR...	Version
Order No.	1353580000	PCB plug-in connector, male plug, 5.08 mm, Number of poles: 2,
GTIN (EAN)	4050118156430	180°, PUSH IN with actuator, Clamping range, max. : 3.31 mm², Box
Qty.	54 ST	

SLT 5.08/180DF SN



Male plugs with screw TOP wire connection. The male plug provides space for labelling and can be coded.

General ordering data

Type	SLT 5.08/02/180DF SN OR...	Version
Order No.	1353350000	PCB plug-in connector, male plug, 5.08 mm, Number of poles: 2,
GTIN (EAN)	4050118156645	180°, TOP connection, Clamping range, max. : 2.5 mm², Box
Qty.	54 ST	

BLZP 5.08HC/02/90 SN OR BX

Weidmüller Interface GmbH & Co. KG
 Klingenbergstraße 26
 D-32758 Detmold
 Germany

www.weidmueller.com

Counterpart

SLT 5.08B

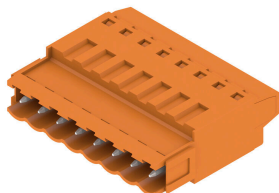

Male plugs with screw TOP wire connection. The male plug provides space for labelling and can be coded.

General ordering data

Type	SLT 5.08/02/180B SN OR ...	Version
Order No.	1611710000	PCB plug-in connector, male plug, 5.08 mm, Number of poles: 2,
GTIN (EAN)	4008190192594	180°, TOP connection, Clamping range, max.: 2.5 mm ² , Box
Qty.	100 ST	

SLS 5.08/180 SN

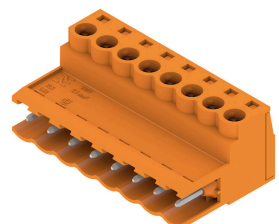

Male plugs with clamping-yoke screw wire-connect system. The male plugs provide space for labelling and can be coded.

General ordering data

Type	SLS 5.08/02/180 SN OR BX	Version
Order No.	1627090000	PCB plug-in connector, male plug, 5.08 mm, Number of poles: 2,
GTIN (EAN)	4008190199609	180°, Clamping yoke connection, Clamping range, max.: 3.31 mm ² ,
Qty.	180 ST	Box

SLS 5.08/180B

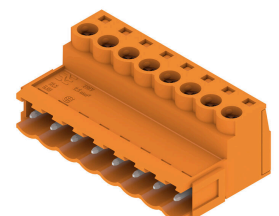

Male plugs with clamping-yoke screw wire-connect system. The male plugs provide space for labelling and can be coded.

General ordering data

Type	SLS 5.08/02/180B SN OR ...	Version
Order No.	1627240000	PCB plug-in connector, male plug, 5.08 mm, Number of poles: 2,
GTIN (EAN)	4008190199753	180°, Clamping yoke connection, Clamping range, max.: 3.31 mm ² ,
Qty.	150 ST	Box