

BLZP 5.08HC/12/180F SN OR BX

Weidmüller Interface GmbH & Co. KG
 Klingenbergstraße 26
 D-32758 Detmold
 Germany

www.weidmueller.com

Product image

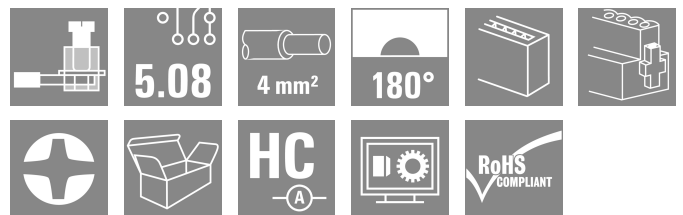
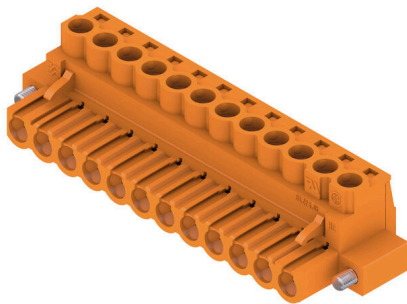

Female plug with clamping-yoke screw system for connecting wires with straight (180°) outlet direction. The female connectors provide space for labelling and can be coded. Fastened by means of a flange or release latch. They also provide an integrated plus/minus screw, protection against faulty insertion of the wire, and they are delivered with open clamping yokes. HC = High Current.

General ordering data

Version	PCB plug-in connector, female plug, 5.08 mm, Number of poles: 12, 180°, Clamping yoke connection, Clamping range, max. : 4 mm ² , Box
Order No.	1944190000
Type	BLZP 5.08HC/12/180F SN OR BX
GTIN (EAN)	4032248618774
Qty.	24 items
Product data	IEC: 400 V / 23 A / 0.2 - 4 mm ² UL: 300 V / 20 A / AWG 26 - AWG 12
Packaging	Box

BLZP 5.08HC/12/180F SN OR BX

Weidmüller Interface GmbH & Co. KG
 Klingenbergstraße 26
 D-32758 Detmold
 Germany

www.weidmueller.com

Technical data

Approvals

Approvals



ROHS	Conform
UL File Number Search	UL Website
Certificate No. (UR)	E60693
Certificate No. (cURus)	E60693

Dimensions and weights

Depth	20 mm	Depth (inches)	0.7874 inch
Height	16.1 mm	Height (inches)	0.6339 inch
Width	70.76 mm	Width (inches)	2.7858 inch
Net weight	21.04 g		

Environmental Product Compliance

RoHS Compliance Status	Compliant without exemption
REACH SVHC	No SVHC above 0.1 wt%

System Parameters

Product family	OMNIMATE Signal - series BL/SL 5.08		
Type of connection	Field connection		
Wire connection method	Clamping yoke connection		
Pitch in mm (P)	5.08 mm		
Pitch in inches (P)	0.200 "		
Conductor outlet direction	180°		
Number of poles	12		
L1 in mm	55.88 mm		
L1 in inches	2.200 "		
Number of rows	1		
Pin series quantity	1		
Rated cross-section	4 mm ²		
Touch-safe protection acc. to DIN VDE 57 106	Safe from finger touch		
Touch-safe protection acc. to DIN VDE 0470	IP20 plugged/ IP10 unplugged		
Protection degree	IP20		
Volume resistance	≤5 mΩ		
Can be coded	Yes		
Stripping length	7 mm		
Clamping screw	M 2.5		
Screwdriver blade	0.6 x 3.5, PH 1, PZ 1		
Screwdriver blade standard	DIN 5264, ISO 8764/2-PH, ISO 8764/2-PZ		
Plugging cycles	25		
Plugging force/pole, max.	10 N		
Pulling force/pole, max.	9 N		
Tightening torque	Torque type		Wire connection
	Usage information		Tightening torque
			min. 0.4 Nm
	Usage information		max. 0.5 Nm
Torque type			Screw flange
Usage information		Tightening torque	
		min. 0.2 Nm	
Usage information		max. 0.25 Nm	

BLZP 5.08HC/12/180F SN OR BX

Weidmüller Interface GmbH & Co. KG
 Klingenbergstraße 26
 D-32758 Detmold
 Germany

www.weidmueller.com

Technical data

Material data

Insulating material	PBT	Colour	orange
Colour chart (similar)	RAL 2000	Insulating material group	Illa
Comparative Tracking Index (CTI)	≥ 200	Moisture Level (MSL)	
UL 94 flammability rating	V-0	Contact material	Cu-alloy
Contact surface	tinned	Layer structure of plug contact	4...8 µm Sn hot-dip tinned
Storage temperature, min.	-40 °C	Storage temperature, max.	70 °C
Operating temperature, min.	-50 °C	Operating temperature, max.	100 °C
Temperature range, installation, min.	-25 °C	Temperature range, installation, max.	100 °C

Conductors suitable for connection

Clamping range, min.	0.13 mm ²
Clamping range, max.	4 mm ²
Wire connection cross section AWG, min.	AWG 30
Wire connection cross section AWG, max.	AWG 12
Solid, min. H05(07) V-U	0.2 mm ²
Solid, max. H05(07) V-U	4 mm ²
Flexible, min. H05(07) V-K	0.2 mm ²
Flexible, max. H05(07) V-K	4 mm ²
w. plastic collar ferrule, DIN 46228 pt 4, min.	0.2 mm ²
w. plastic collar ferrule, DIN 46228 pt 4, max.	2.5 mm ²
w. wire end ferrule, DIN 46228 pt 1, min.	0.2 mm ²
w. wire end ferrule, DIN 46228 pt 1, max.	4 mm ²
Plug gauge in accordance with EN 60999 a x b; ø	2.8 mm x 2.4 mm

Clampable conductor	Cross-section for conductor connection	Type	fine-wired
		nominal	0.5 mm ²
wire end ferrule	wire end ferrule	Stripping length	nominal 6 mm
		Recommended wire-end ferrule	H0.5/6
		Stripping length	nominal 8 mm
		Recommended wire-end ferrule	H0.5/12 OR
Cross-section for conductor connection	wire end ferrule	Type	fine-wired
		nominal	1 mm ²
wire end ferrule	wire end ferrule	Stripping length	nominal 6 mm
		Recommended wire-end ferrule	H1.0/6
		Stripping length	nominal 7 mm
		Recommended wire-end ferrule	H1.5/7
Cross-section for conductor connection	wire end ferrule	Type	fine-wired
		nominal	1.5 mm ²
wire end ferrule	wire end ferrule	Stripping length	nominal 7 mm
		Recommended wire-end ferrule	H1.5/7
		Stripping length	nominal 10 mm
		Recommended wire-end ferrule	H2.5/15D BL
Cross-section for conductor connection	wire end ferrule	Type	fine-wired
		nominal	2.5 mm ²
wire end ferrule	wire end ferrule	Stripping length	nominal 7 mm
		Recommended wire-end ferrule	H2.5/7
		Stripping length	nominal 10 mm
		Recommended wire-end ferrule	H2.5/15D BL

BLZP 5.08HC/12/180F SN OR BX

Weidmüller Interface GmbH & Co. KG
 Klingenbergstraße 26
 D-32758 Detmold
 Germany

www.weidmueller.com

Technical data

Reference text The outside diameter of the plastic collar should not be larger than the pitch (P), Length of ferrules is to be chosen depending on the product and the rated voltage.

Rated data acc. to IEC

tested acc. to standard	IEC 60664-1, IEC 61984	Rated current, min. number of poles (Tu=20°C)	23 A
Rated current, max. number of poles (Tu=20°C)	18 A	Rated current, min. number of poles (Tu=40°C)	21 A
Rated current, max. number of poles (Tu=40°C)	16 A	Rated voltage for surge voltage class / pollution degree II/2	400 V
Rated voltage for surge voltage class / pollution degree III/2	320 V	Rated voltage for surge voltage class / pollution degree III/3	250 V
Rated impulse voltage for surge voltage class/ pollution degree II/2	4000 V	Rated impulse voltage for surge voltage class/ pollution degree III/2	4 kV
Rated impulse voltage for surge voltage class/ contamination degree III/3	4 kV	Short-time withstand current resistance	3 x 1s with 120 A

Rated data acc. to CSA

Institute (CSA)	CSA	Certificate No. (CSA)	200039-1121690
Rated voltage (Use group B / CSA)	300 V	Rated voltage (Use group C / CSA)	50 V
Rated voltage (Use group D / CSA)	300 V	Rated current (Use group B / CSA)	20 A
Rated current (Use group D / CSA)	20 A	Wire cross-section, AWG, min.	AWG 30
Wire cross-section, AWG, max.	AWG 12	Reference to approval values	Specifications are maximum values, details - see approval certificate.

Rated data acc. to UL 1059

Institute (UR)	UR	Certificate No. (UR)	E60693
Institute (cURus)	CURUS	Certificate No. (cURus)	E60693
Rated voltage (Use group B / UL 1059)	300 V	Rated voltage (Use group D / UL 1059)	300 V
Rated current (Use group B / UL 1059)	20 A	Rated current (Use group D / UL 1059)	10 A
Wire cross-section, AWG, min.	AWG 26	Wire cross-section, AWG, max.	AWG 12
Reference to approval values	Specifications are maximum values, details - see approval certificate.		

Packing

Packaging	Box	VPE length	349.00 mm
VPE width	136.00 mm	VPE height	31.00 mm

Type tests

Test: Durability of markings	Standard	DIN EN 61984 section 7.3.2 / 09.02 taking pattern from DIN EN 60068-2-70 / 07.96
	Test	mark of origin, rated voltage, rated cross-section, type of material
	Evaluation	available
	Test	durability
Test: Misengagement (Non-interchangeability)	Evaluation	passed
	Standard	DIN EN 60512-13-5 / 1.1.06, IEC 60512-13-5 / 02.06
	Test	180° turned with coding elements
	Evaluation	passed
Test: Misengagement (Non-interchangeability)	Test	visual examination
	Evaluation	passed

BLZP 5.08HC/12/180F SN OR BX

Weidmüller Interface GmbH & Co. KG
 Klingenbergstraße 26
 D-32758 Detmold
 Germany

www.weidmueller.com

Technical data

Test: Clampable cross section	Standard	DIN EN 60999-1 section 7 and 9.1 / 12.00, DIN EN 60947-1 section 8.2.4.5.1 / 12.02	
	Conductor type	Type of conductor and conductor cross-section	solid 0.2 mm ²
		Type of conductor and conductor cross-section	stranded 0.2 mm ²
		Type of conductor and conductor cross-section	solid 2.5 mm ²
		Type of conductor and conductor cross-section	stranded 2.5 mm ²
		Type of conductor and conductor cross-section	AWG 26/1
		Type of conductor and conductor cross-section	AWG 26/19
Evaluation	passed		
Test for damage to and accidental loosening of conductors	Standard	DIN EN 60999-1 section 9.4 / 12.00	
	Requirement	0.2 kg	
	Conductor type	Type of conductor and conductor cross-section	AWG 26/1
		Type of conductor and conductor cross-section	AWG 26/19
	Evaluation	passed	
	Requirement	0.3 kg	
	Conductor type	Type of conductor and conductor cross-section	solid 0.5 mm ²
		Type of conductor and conductor cross-section	stranded 0.5 mm ²
	Evaluation	passed	
	Requirement	0.9 kg	
Pull-out test	Conductor type	Type of conductor and conductor cross-section	AWG 12/1
		Type of conductor and conductor cross-section	AWG 12/19
	Evaluation	passed	
	Requirement	≥10 N	
	Conductor type	Type of conductor and conductor cross-section	AWG 26/1
Type of conductor and conductor cross-section		AWG 26/19	
Evaluation		passed	
Requirement	≥20 N		
Conductor type	Type of conductor and conductor cross-section	H05V-U0.5	
	Type of conductor and conductor cross-section	H05V-K0.5	
Evaluation	passed		

BLZP 5.08HC/12/180F SN OR BX

Weidmüller Interface GmbH & Co. KG
 Klingenbergstraße 26
 D-32758 Detmold
 Germany

www.weidmueller.com

Technical data

Requirement	≥60 N
Conductor type	Type of conductor and conductor cross-section H07V-U4.0
	Type of conductor and conductor cross-section H07V-K4.0
	Type of conductor and conductor cross-section AWG 12/1
	Type of conductor and conductor cross-section AWG 12/19
Evaluation	passed

Important note

IPC conformity Conformity: The products are developed, manufactured and delivered according international recognized standards and norms and comply with the assured properties in the data sheet resp. fulfill decorative properties in accordance with IPC-A-610 "Class 2". Further claims on the products can be evaluated on request.

- Notes**
- Additional variants on request
 - Gold-plated contact surfaces on request
 - Rated current related to rated cross-section & min. No. of poles.
 - Wire end ferrule without plastic collar to DIN 46228/1
 - Wire end ferrule with plastic collar to DIN 46228/4
 - P on drawing = pitch
 - Rated data refer only to the component itself. Clearance and creepage distances to other components are to be designed in accordance with the relevant application standards.
 - In accordance with IEC 61984, OMNIMATE-connectors are connectors without breaking capacity (COC). During designated use, connectors are not allowed to be engaged or disengaged when live or under load
 - Long term storage of the product with average temperature of 50 °C and maximum humidity 70%, 36 months

Classifications

ETIM 8.0	EC002638	ETIM 9.0	EC002638
ETIM 10.0	EC002638	ECLASS 14.0	27-46-02-02
ECLASS 15.0	27-46-02-02		

BLZP 5.08HC/12/180F SN OR BX

Weidmüller Interface GmbH & Co. KG
 Klingenbergstraße 26
 D-32758 Detmold
 Germany

www.weidmueller.com

Drawings

Product image

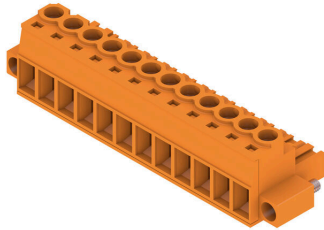

Dimensional drawing

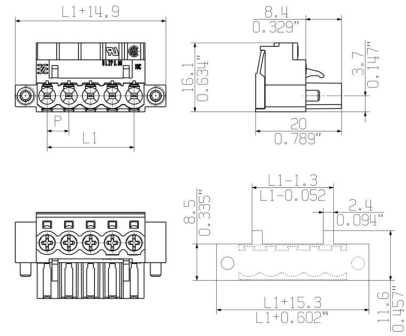

MIN. FRONT PLATE CUT-OUT

Graph

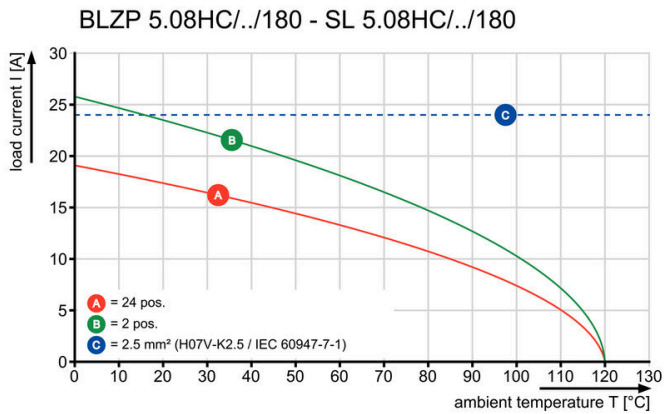

BLZP 5.08HC/12/180F SN OR BX

Weidmüller Interface GmbH & Co. KG
 Klingenbergstraße 26
 D-32758 Detmold
 Germany

www.weidmueller.com

Accessories

Strain reliefs



For frequent load changes: the "trailer coupling" for plug-in connectors.

The strain relief can do more than just relieve the strain on conductors:

Simply clip onto the plug and

- bundle conductors
- guide cables
- use as a connection and disconnection aid

No damage to the connecting points, clear, tidy wiring and easy to handle.

User advantages: permanent heavy-duty connections for harsh industrial environments and convenient operation ensure improved system availability.

General ordering data

Type	BLZ 5.08 ZE04 OR BX	Version
Order No.	1652110000	PCB plug-in connector, Accessories, Strain relief, orange, Number of
GTIN (EAN)	4008190401788	poles: 4
Qty.	50 ST	
Type	BLZ 5.08 ZE04 BK BX	Version
Order No.	1652130000	PCB plug-in connector, Accessories, Strain relief, black, Number of
GTIN (EAN)	4008190401801	poles: 4
Qty.	50 ST	
Type	BLZ 5.08 ZE08 OR BX	Version
Order No.	1652050000	PCB plug-in connector, Accessories, Strain relief, orange, Number of
GTIN (EAN)	4008190401726	poles: 8
Qty.	50 ST	
Type	BLZ 5.08 ZE08 BK BX	Version
Order No.	1652070000	PCB plug-in connector, Accessories, Strain relief, black, Number of
GTIN (EAN)	4008190401740	poles: 8
Qty.	50 ST	

Coding elements

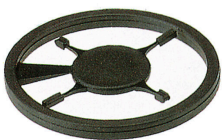

Only connects what is supposed to be connected: the right connection at the right place.

Coding elements and locking devices clearly assign connecting elements during the manufacturing process and operation

The coding elements and locking devices are inserted prior to assembly or during the cable assembly phase.

The Weidmüller alternative: configure online using the variant configurator to precode prior to delivery.

Incorrect assembly on the circuit board and incorrect plugging of connecting elements is no longer possible.

The advantage: no troubleshooting during manufacture and no operational errors by the user.

General ordering data

Type	BLZ/SL KO OR BX	Version
Order No.	1573010000	PCB plug-in connector, Accessories, Coding element, orange, Number
GTIN (EAN)	4008190048396	of poles: 1
Qty.	100 ST	

BLZP 5.08HC/12/180F SN OR BX

Weidmüller Interface GmbH & Co. KG
 Klingenbergstraße 26
 D-32758 Detmold
 Germany

www.weidmueller.com

Accessories

Type	BLZ/SL KO BK BX	Version
Order No.	1545710000	PCB plug-in connector, Accessories, Coding element, black, Number
GTIN (EAN)	4008190087142	of poles: 1
Qty.	50 ST	

Slotted screwdriver

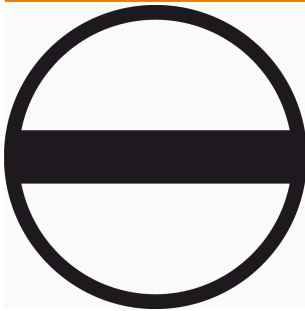

Slotted screwdriver with rounded blade SD DIN 5265, ISO 2380/2, output to DIN 5264, ISO 2380/1. ChromTop tip, SoftFinish grip

General ordering data

Type	SDS 0.6X3.5X100	Version
Order No.	2749340000	Screwdriver, Blade width (B): 3.5 mm, Blade length: 100 mm, Blade thickness (A): 0.6 mm
GTIN (EAN)	4050118895568	
Qty.	1 ST	
Type	SDIS 0.6X3.5X100	Version
Order No.	2749810000	Screwdriver, Blade width (B): 3.5 mm, Blade length: 100 mm, Blade thickness (A): 0.6 mm
GTIN (EAN)	4050118897012	
Qty.	1 ST	

Crosshead screwdriver Phillips



Crosshead screwdriver, Phillips, SDK PH DIN 5262, ISO 8764/2-PH, output to ISO 8764-PH, ChromTop tip, SoftFinish grip

General ordering data

Type	SDK PH1 X 80	Version
Order No.	2749410000	Screwdriver, Blade width (B): 4.5 mm, 80 mm, Blade thickness (A): 1
GTIN (EAN)	4050118895636	
Qty.	1 ST	

BLZP 5.08HC/12/180F SN OR BX

Weidmüller Interface GmbH & Co. KG
Klingenbergstraße 26
D-32758 Detmold
Germany

www.weidmueller.com

Accessories

Crosshead screwdriver Pozidriv



Crosshead screwdriver, Pozidriv, SDK PZ DIN 5262, ISO 8764/2-PZ, output to ISO 8764/1-PZ, ChromTop tip, SoftFinish grip

General ordering data

Type	SDK PZ1 X 80	Version	
Order No.	2749440000	Screwdriver, Blade width (B): 14.5 mm, 80 mm, Blade thickness (A): 1	
GTIN (EAN)	4050118895667		
Qty.	1 ST		

BLZP 5.08HC/12/180F SN OR BX

Weidmüller Interface GmbH & Co. KG
Klingenbergstraße 26
D-32758 Detmold
Germany

Counterpart

www.weidmueller.com

SL 5.08HC/180F

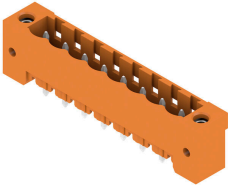

Pin headers in glass-fibre-reinforced plastic with straight wire outlet; optimised for wave soldering. The flange variant (F) can be screwed onto the respective counter piece or the circuit board. There is no need for an extra screw to connect the circuit board when the solder flange (LF) version is used. This also protects the solder points from mechanical strain. All pin headers can be manually coded or ordered pre-coded. HC = High Current.

General ordering data

Type	SL 5.08HC/12/180F 3.2SN...	Version
Order No.	1148790000	PCB plug-in connector, male header, Flange, THT solder connection,
GTIN (EAN)	4032248932658	5.08 mm, Number of poles: 12, 180°, Solder pin length (l): 3.2 mm,
Qty.	24 ST	tinned, black, Box
Type	SL 5.08HC/12/180F 3.2SN...	Version
Order No.	1147440000	PCB plug-in connector, male header, Flange, THT solder connection,
GTIN (EAN)	4032248931163	5.08 mm, Number of poles: 12, 180°, Solder pin length (l): 3.2 mm,
Qty.	24 ST	tinned, orange, Box

SL 5.08HC/180LF

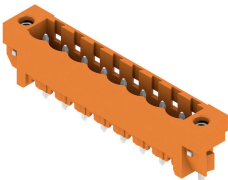

Pin headers in glass-fibre-reinforced plastic with straight wire outlet; optimised for wave soldering. The flange variant (F) can be screwed onto the respective counter piece or the circuit board. There is no need for an extra screw to connect the circuit board when the solder flange (LF) version is used. This also protects the solder points from mechanical strain. All pin headers can be manually coded or ordered pre-coded. HC = High Current.

General ordering data

Type	SL 5.08HC/12/180LF 3.2S...	Version
Order No.	1149550000	PCB plug-in connector, male header, Solder flange, THT solder
GTIN (EAN)	4032248932924	connection, 5.08 mm, Number of poles: 12, 180°, Solder pin length
Qty.	24 ST	(l): 3.2 mm, tinned, black, Box
Type	SL 5.08HC/12/180LF 3.2S...	Version
Order No.	1148220000	PCB plug-in connector, male header, Solder flange, THT solder
GTIN (EAN)	4032248931828	connection, 5.08 mm, Number of poles: 12, 180°, Solder pin length
Qty.	24 ST	(l): 3.2 mm, tinned, orange, Box

BLZP 5.08HC/12/180F SN OR BX

Weidmüller Interface GmbH & Co. KG
Klingenbergstraße 26
D-32758 Detmold
Germany

Counterpart

www.weidmueller.com

SL 5.08HC/90F

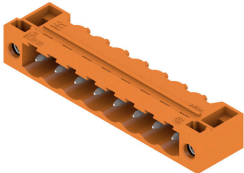

Pin headers made from glass-fibre-reinforced plastic with 90° wire outlet; optimised for wave soldering. The flange variant (F) can be screwed onto the respective counter piece or the circuit board. There is no need for an extra screw to connect the circuit board when the solder flange (LF) version is used. This also protects the solder points from mechanical strain. All pin headers can be manually coded or ordered pre-coded. HC = High Current.

General ordering data

Type	SL 5.08HC/12/90F 3.2SN ...	Version
Order No.	1150200000	PCB plug-in connector, male header, Flange, THT solder connection,
GTIN (EAN)	4032248937073	5.08 mm, Number of poles: 12, 90°, Solder pin length (l): 3.2 mm,
Qty.	24 ST	tinned, black, Box
Type	SL 5.08HC/12/90F 3.2SN ...	Version
Order No.	1148940000	PCB plug-in connector, male header, Flange, THT solder connection,
GTIN (EAN)	4032248935772	5.08 mm, Number of poles: 12, 90°, Solder pin length (l): 3.2 mm,
Qty.	24 ST	tinned, orange, Box

SL 5.08HC/90LF

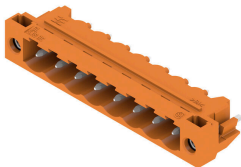

Pin headers made from glass-fibre-reinforced plastic with 90° wire outlet; optimised for wave soldering. The flange variant (F) can be screwed onto the respective counter piece or the circuit board. There is no need for an extra screw to connect the circuit board when the solder flange (LF) version is used. This also protects the solder points from mechanical strain. All pin headers can be manually coded or ordered pre-coded. HC = High Current.

General ordering data

Type	SL 5.08HC/12/90LF 3.2SN...	Version
Order No.	1150450000	PCB plug-in connector, male header, Solder flange, THT solder
GTIN (EAN)	4032248936779	connection, 5.08 mm, Number of poles: 12, 90°, Solder pin length (l):
Qty.	24 ST	3.2 mm, tinned, black, Box
Type	SL 5.08HC/12/90LF 3.2SN...	Version
Order No.	1149710000	PCB plug-in connector, male header, Solder flange, THT solder
GTIN (EAN)	4032248936588	connection, 5.08 mm, Number of poles: 12, 90°, Solder pin length (l):
Qty.	24 ST	3.2 mm, tinned, orange, Box

BLZP 5.08HC/12/180F SN OR BX

Weidmüller Interface GmbH & Co. KG
 Klingenbergstraße 26
 D-32758 Detmold
 Germany

www.weidmueller.com

Counterpart

SL-SMT 5.08/180F Box



High-temperature-resistant pin header, packed in box or tape. On tape, with 1.5 mm solder pin, optimised for automatic assembly. 3.2 mm solder pin suitable for reflow and wave soldering. The pin headers provide space for labelling and can be coded. HC = High Current.

General ordering data

Type	SL-SMT 5.08HC/12/180F 3...	Version
Order No.	1820630000	PCB plug-in connector, male header, Flange, THT/THR solder
GTIN (EAN)	4032248316595	connection, 5.08 mm, Number of poles: 12, 180°, Solder pin length
Qty.	24 ST	(l): 3.2 mm, tinned, black, Box

SL-SMT 5.08/180LF Box



High-temperature-resistant pin header, packed in box or tape. On tape, with 1.5 mm solder pin, optimised for automatic assembly. 3.2 mm solder pin suitable for reflow and wave soldering. The pin headers provide space for labelling and can be coded. HC = High Current.

General ordering data

Type	SL-SMT 5.08HC/12/180LF ...	Version
Order No.	1776462001	PCB plug-in connector, male header, Solder flange, THT/THR solder
GTIN (EAN)	4032248159345	connection, 5.08 mm, Number of poles: 12, 180°, Solder pin length
Qty.	24 ST	(l): 1.5 mm, tinned, black, Box
Type	SL-SMT 5.08HC/12/180LF ...	Version
Order No.	1838540000	PCB plug-in connector, male header, Solder flange, THT/THR solder
GTIN (EAN)	4032248348602	connection, 5.08 mm, Number of poles: 12, 180°, Solder pin length
Qty.	24 ST	(l): 3.2 mm, tinned, black, Box

SL-SMT 5.08HC/90F Box



High-temperature-resistant pin header, packed in box or tape. On tape, with 1.5 mm solder pin, optimised for automatic assembly. 3.2 mm solder pin suitable for reflow and wave soldering. The pin headers provide space for labelling and can be coded. HC = High Current.

BLZP 5.08HC/12/180F SN OR BX

Weidmüller Interface GmbH & Co. KG
 Klingenbergstraße 26
 D-32758 Detmold
 Germany

www.weidmueller.com

Counterpart**General ordering data**

Type	SL-SMT 5.08HC/12/90F 3...	Version
Order No.	1837730000	PCB plug-in connector, male header, Flange, THT/THR solder
GTIN (EAN)	4032248347544	connection, 5.08 mm, Number of poles: 12, 90°, Solder pin length (l):
Qty.	24 ST	3.2 mm, tinned, black, Box

SL-SMT 5.08HC/90LF Box

High-temperature-resistant pin header, packed in box or tape. On tape, with 1.5 mm solder pin, optimised for automatic assembly. 3.2 mm solder pin suitable for reflow and wave soldering. The pin headers provide space for labelling and can be coded. HC = High Current.

General ordering data

Type	SL-SMT 5.08HC/12/90LF 1...	Version
Order No.	1775332001	PCB plug-in connector, male header, Solder flange, THT/THR solder
GTIN (EAN)	4032248157310	connection, 5.08 mm, Number of poles: 12, 90°, Solder pin length (l):
Qty.	24 ST	1.5 mm, tinned, black, Box
Type	SL-SMT 5.08HC/12/90LF 3...	Version
Order No.	1780510000	PCB plug-in connector, male header, Solder flange, THT/THR solder
GTIN (EAN)	4032248165834	connection, 5.08 mm, Number of poles: 12, 90°, Solder pin length (l):
Qty.	24 ST	3.2 mm, tinned, black, Box

SLDV-THR 5.08/180F

High-temperature resistant, double level, laterally offset, male connector with flange or solder flange. 1.5 mm solder pin is suitable for reflow soldering. 3.2 mm solder pin suitable for reflow and wave soldering. The pin headers provide space for labelling and can be coded.

General ordering data

Type	SLDV-THR 5.08/24/180F 1...	Version
Order No.	1828990000	PCB plug-in connector, male header, Flange, THT/THR solder
GTIN (EAN)	4032248335688	connection, 5.08 mm, Number of poles: 24, 180°, Solder pin length
Qty.	16 ST	(l): 1.5 mm, tinned, black, Box
Type	SLDV-THR 5.08/24/180F 3...	Version
Order No.	1828870000	PCB plug-in connector, male header, Flange, THT/THR solder
GTIN (EAN)	4032248335565	connection, 5.08 mm, Number of poles: 24, 180°, Solder pin length
Qty.	16 ST	(l): 3.2 mm, tinned, black, Box

BLZP 5.08HC/12/180F SN OR BX

Weidmüller Interface GmbH & Co. KG
 Klingenbergstraße 26
 D-32758 Detmold
 Germany

Counterpart

www.weidmueller.com

SLDV-THR 5.08/180FLF



High-temperature resistant, double level, laterally offset, male connector with flange or solder flange. 1.5 mm solder pin is suitable for reflow soldering. 3.2 mm solder pin suitable for reflow and wave soldering. The pin headers provide space for labelling and can be coded.

General ordering data

Type	SLDV-THR 5.08/24/180FLF...	Version
Order No.	1829230000	PCB plug-in connector, male header, Flange / Solder flange, THT/THR
GTIN (EAN)	4032248335923	solder connection, 5.08 mm, Number of poles: 24, 180°, Solder pin
Qty.	16 ST	length (l): 1.5 mm, tinned, black, Box
Type	SLDV-THR 5.08/24/180FLF...	Version
Order No.	1829110000	PCB plug-in connector, male header, Flange / Solder flange, THT/THR
GTIN (EAN)	4032248335800	solder connection, 5.08 mm, Number of poles: 24, 180°, Solder pin
Qty.	16 ST	length (l): 3.2 mm, tinned, black, Box

SLF 5.08/180F SN

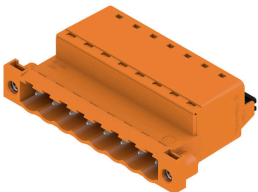

Male plug with PUSH IN wire connection and straight outlet direction, when used with BLF 5.08HC as wire-to-wire application for panel feed-through The male plugs provide space for labelling and can be coded.

General ordering data

Type	SLF 5.08/12/180F SN BK ...	Version
Order No.	1336280000	PCB plug-in connector, male plug, 5.08 mm, Number of poles: 12,
GTIN (EAN)	4050118140088	180°, PUSH IN with actuator, Clamping range, max. : 3.31 mm², Box
Qty.	24 ST	
Type	SLF 5.08/12/180F SN OR ...	Version
Order No.	1335800000	PCB plug-in connector, male plug, 5.08 mm, Number of poles: 12,
GTIN (EAN)	4050118139471	180°, PUSH IN with actuator, Clamping range, max. : 3.31 mm², Box
Qty.	24 ST	

BLZP 5.08HC/12/180F SN OR BX

Weidmüller Interface GmbH & Co. KG
 Klingenbergstraße 26
 D-32758 Detmold
 Germany

www.weidmueller.com

Counterpart

SLF 5.08/180FI SN

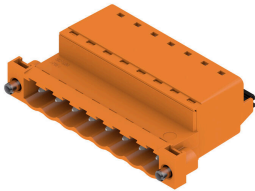

Male plug with PUSH IN wire connection and straight outlet direction, when used with BLF 5.08HC as wire-to-wire application for panel feed-through The male plugs provide space for labelling and can be coded.

General ordering data

Type	SLF 5.08/12/180FI SN BK...	Version
Order No.	1336150000	PCB plug-in connector, male plug, 5.08 mm, Number of poles: 12,
GTIN (EAN)	4050118139785	180°, PUSH IN with actuator, Clamping range, max. : 3.31 mm², Box
Qty.	24 ST	
Type	SLF 5.08/12/180FI SN OR...	Version
Order No.	1336510000	PCB plug-in connector, male plug, 5.08 mm, Number of poles: 12,
GTIN (EAN)	4050118140743	180°, PUSH IN with actuator, Clamping range, max. : 3.31 mm², Box
Qty.	24 ST	

SLS 5.08/180F



Male plugs with clamping-yoke screw wire-connect system. The male plugs provide space for labelling and can be coded.

General ordering data

Type	SLS 5.08/12/180F SN OR ...	Version
Order No.	1846460000	PCB plug-in connector, male plug, 5.08 mm, Number of poles: 12,
GTIN (EAN)	4032248362769	180°, Clamping yoke connection, Clamping range, max. : 3.31 mm²,
Qty.	24 ST	Box

SLS 5.08/180FI

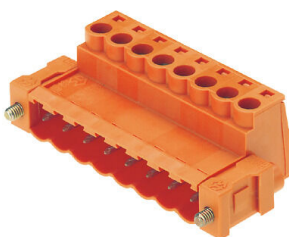

Male plugs with clamping-yoke screw wire-connect system. The male plugs provide space for labelling and can be coded.

BLZP 5.08HC/12/180F SN OR BX

Weidmüller Interface GmbH & Co. KG
Klingenbergstraße 26
D-32758 Detmold
Germany

Counterpart

www.weidmueller.com

General ordering data

Type	SLS 5.08/12/180FI SN OR...	Version
Order No.	1846310000	PCB plug-in connector, male plug, 5.08 mm, Number of poles: 12,
GTIN (EAN)	4032248362592	180°, Clamping yoke connection, Clamping range, max. : 3.31 mm²,
Qty.	24 ST	Box