

## BL-I/O 3.50/10F NPN LED SN BK BX

**Weidmüller Interface GmbH & Co. KG**  
 Klingenbergstraße 26  
 D-32758 Detmold  
 Germany

www.weidmueller.com



Female plugs with spring connection (PUSH IN) as a plug-in connection level for decentralised I/O electronic components; used together with male headers in a 3.50-mm pitch.

### General ordering data

Version	PCB plug-in connector, female plug, 3.50 mm, Number of poles: 10, 180°, PUSH IN with actuator, Clamping range, max. : 1.5 mm <sup>2</sup> , Box
Order No.	<a href="#">1938010000</a>
Type	BL-I/O 3.50/10F NPN LED SN BK BX
GTIN (EAN)	4032248610228
Qty.	20 items
Product data	IEC: 200 V / 2.2 A / 0.2 - 1.5 mm <sup>2</sup> UL: 50 V / 5 A / AWG 24 - AWG 16
Packaging	Box

**BL-I/O 3.50/10F NPN LED SN BK BX**

**Weidmüller Interface GmbH & Co. KG**  
 Klingenbergstraße 26  
 D-32758 Detmold  
 Germany

www.weidmueller.com

**Technical data**

**Approvals**

Approvals



ROHS	Conform
UL File Number Search	<a href="#">UL Website</a>
Certificate No. (UR)	E60693

**Dimensions and weights**

Depth	27.6 mm	Depth (inches)	1.0866 inch
Height	10.3 mm	Height (inches)	0.4055 inch
Width	42 mm	Width (inches)	1.6535 inch
Net weight	11.97 g		

**Environmental Product Compliance**

RoHS Compliance Status	Compliant with exemption
RoHS Exemption (if applicable/known)	7cl
REACH SVHC	No SVHC above 0.1 wt%

**System Parameters**

Product family	OMNIMATE Signal - series BL/SL 3.50		
Type of connection	Field connection		
Wire connection method	PUSH IN with actuator		
Pitch in mm (P)	3.50 mm		
Pitch in inches (P)	0.138 "		
Conductor outlet direction	180°		
Number of poles	10		
L1 in mm	31.50 mm		
L1 in inches	1.240 "		
Number of rows	1		
Pin series quantity	2		
Rated cross-section	1 mm <sup>2</sup>		
Touch-safe protection acc. to DIN VDE 57 106	Safe from finger touch		
Touch-safe protection acc. to DIN VDE 0470	IP20 plugged/ IP10 unplugged		
Volume resistance	≤5 mΩ		
Can be coded	Yes		
Stripping length	8 mm		
Screwdriver blade	0.4 x 2.5		
Screwdriver blade standard	DIN 5264		
Plugging cycles	25		
Plugging force/pole, max.	6 N		
Pulling force/pole, max.	6 N		
Tightening torque	Torque type	Screw flange	
	Usage information	Tightening torque	min. 0.15 Nm max. 0.2 Nm

**Material data**

Insulating material	PBT	Colour	black
Colour chart (similar)	RAL 9011	Insulating material group	IIIa

## BL-I/O 3.50/10F NPN LED SN BK BX

**Weidmüller Interface GmbH & Co. KG**

Klingenbergstraße 26  
D-32758 Detmold  
Germany

www.weidmueller.com

## Technical data

Comparative Tracking Index (CTI)	≥ 200	Moisture Level (MSL)	
UL 94 flammability rating	V-0	Contact base material	Cu-alloy
Contact material	Cu-alloy	Contact surface	tinned
Storage temperature, min.	-40 °C	Storage temperature, max.	70 °C
Operating temperature, min.	-50 °C	Operating temperature, max.	75 °C
Temperature range, installation, min.	-30 °C	Temperature range, installation, max.	75 °C

### Conductors suitable for connection

Clamping range, min.	0.2 mm <sup>2</sup>
Clamping range, max.	1.5 mm <sup>2</sup>
Wire connection cross section AWG, min.	AWG 24
Wire connection cross section AWG, max.	AWG 16
Solid, min. H05(07) V-U	0.2 mm <sup>2</sup>
Solid, max. H05(07) V-U	1.5 mm <sup>2</sup>
Flexible, min. H05(07) V-K	0.2 mm <sup>2</sup>
Flexible, max. H05(07) V-K	1.5 mm <sup>2</sup>
w. plastic collar ferrule, DIN 46228 pt 4, min.	0.2 mm <sup>2</sup>
w. plastic collar ferrule, DIN 46228 pt 4, max.	0.75 mm <sup>2</sup>
w. wire end ferrule, DIN 46228 pt 1, min.	0.2 mm <sup>2</sup>
w. wire end ferrule, DIN 46228 pt 1, max.	1 mm <sup>2</sup>
Plug gauge in accordance with EN 60999 a x b; ø	2.4 mm x 1.5 mm; 1.9mm

Clampable conductor	Cross-section for conductor connection	Type	fine-wired
		nominal	0.25 mm <sup>2</sup>
wire end ferrule	wire end ferrule	Stripping length	nominal 10 mm
		Recommended wire-end ferrule	<a href="#">H0.25/12 HBL</a>
Cross-section for conductor connection	wire end ferrule	Type	fine-wired
		nominal	0.34 mm <sup>2</sup>
wire end ferrule	wire end ferrule	Stripping length	nominal 10 mm
		Recommended wire-end ferrule	<a href="#">H0.34/12 TK</a>
Cross-section for conductor connection	wire end ferrule	Type	fine-wired
		nominal	0.5 mm <sup>2</sup>
wire end ferrule	wire end ferrule	Stripping length	nominal 10 mm
		Recommended wire-end ferrule	<a href="#">H0.5/14 OR</a>
Cross-section for conductor connection	wire end ferrule	Type	fine-wired
		nominal	0.75 mm <sup>2</sup>
wire end ferrule	wire end ferrule	Stripping length	nominal 10 mm
		Recommended wire-end ferrule	<a href="#">H0.75/14T HBL</a>

Reference text The outside diameter of the plastic collar should not be larger than the pitch (P). Length of ferrules is to be chosen depending on the product and the rated voltage.

### Rated data acc. to IEC

tested acc. to standard	IEC 60664-1, IEC 61984	Rated current, min. number of poles (Tu=20°C)	2.2 A
Rated current, max. number of poles (Tu=20°C)	2 A	Rated current, min. number of poles (Tu=40°C)	2.2 A

## BL-I/O 3.50/10F NPN LED SN BK BX

**Weidmüller Interface GmbH & Co. KG**  
 Klingenbergstraße 26  
 D-32758 Detmold  
 Germany

www.weidmueller.com

### Technical data

Rated current, max. number of poles (Tu=40°C)	2 A	Rated voltage for surge voltage class / pollution degree II/2	200 V
Rated voltage for surge voltage class / pollution degree III/2	160 V	Rated voltage for surge voltage class / pollution degree III/3	50 V
Rated impulse voltage for surge voltage class/ pollution degree II/2	2500 V	Rated impulse voltage for surge voltage class/ pollution degree III/2	2.5 kV
Rated impulse voltage for surge voltage class/ contamination degree III/3	0.8 kV	Short-time withstand current resistance	3 x 1s with 120 A

### Rated data acc. to CSA

Institute (CSA)	CSA	Certificate No. (CSA)	200039-1202189
Rated voltage (Use group B / CSA)	50 V	Rated voltage (Use group D / CSA)	50 V
Rated current (Use group B / CSA)	5 A	Rated current (Use group D / CSA)	5 A
Wire cross-section, AWG, min.	AWG 22	Wire cross-section, AWG, max.	AWG 16
Reference to approval values	Specifications are maximum values, details - see approval certificate.		

### Rated data acc. to UL 1059

Institute (UR)	UR	Certificate No. (UR)	E60693
Rated voltage (Use group B / UL 1059)	50 V	Rated voltage (Use group D / UL 1059)	50 V
Rated current (Use group B / UL 1059)	5 A	Rated current (Use group D / UL 1059)	5 A
Wire cross-section, AWG, min.	AWG 24	Wire cross-section, AWG, max.	AWG 16
Reference to approval values	Specifications are maximum values, details - see approval certificate.		

### Packing

Packaging	Box	VPE length	165.00 mm
VPE width	97.00 mm	VPE height	43.00 mm

### Type tests

Test: Durability of markings	Standard	draft DIN VDE 0627 section 6.2.2 / 09.91		
	Test	mark of origin, type identification, pitch, type of material		
	Evaluation	available		
	Test	durability		
Test: Clampable cross section	Evaluation	passed		
	Standard	DIN EN 60999-1 section 7 and 9.1 / 12.00, DIN EN 60947-1 section 8.2.4.5.1 / 12.99		
	Conductor type	Type of conductor and conductor cross-section	solid 0.2 mm <sup>2</sup>	
		Type of conductor and conductor cross-section	stranded 0.2 mm <sup>2</sup>	
		Type of conductor and conductor cross-section	solid 1.5 mm <sup>2</sup>	
		Type of conductor and conductor cross-section	stranded 1.5 mm <sup>2</sup>	
Type of conductor and conductor cross-section		AWG 24/1		

**BL-I/O 3.50/10F NPN LED SN BK BX**

**Weidmüller Interface GmbH & Co. KG**  
 Klingenbergstraße 26  
 D-32758 Detmold  
 Germany

www.weidmueller.com

**Technical data**

Test for damage to and accidental loosening of conductors		Type of conductor and conductor cross-section	AWG 24/19
		Type of conductor and conductor cross-section	AWG 16/1
		Type of conductor and conductor cross-section	AWG 16/19
	Evaluation	passed	
	Standard	DIN EN 60999 section 8.4 / 04.94	
	Requirement	0.2 kg	
	Conductor type	Type of conductor and conductor cross-section	stranded 0.05 mm <sup>2</sup>
	Evaluation	passed	
	Requirement	0.3 kg	
	Conductor type	Type of conductor and conductor cross-section	solid 0.5 mm <sup>2</sup>
Pull-out test		Type of conductor and conductor cross-section	AWG 24/1
		Type of conductor and conductor cross-section	AWG 24/19
	Evaluation	passed	
	Requirement	0.4 kg	
	Conductor type	Type of conductor and conductor cross-section	solid 1.5 mm <sup>2</sup>
		Type of conductor and conductor cross-section	stranded 1.5 mm <sup>2</sup>
		Type of conductor and conductor cross-section	AWG 16/1
		Type of conductor and conductor cross-section	AWG 16/19
	Evaluation	passed	
	Standard	DIN EN 60999 section 8.5 / 04.94	
Requirement	≥10 N		
Conductor type	Type of conductor and conductor cross-section	AWG 24/1	
	Type of conductor and conductor cross-section	AWG 24/19	
Evaluation	passed		
Requirement	≥30 N		
Conductor type	Type of conductor and conductor cross-section	H05V-U0.5	
	Type of conductor and conductor cross-section	H05V-K0.5	
Evaluation	passed		
Requirement	≥40 N		
Conductor type	Type of conductor and conductor cross-section	H05V-U1.5	

**BL-I/O 3.50/10F NPN LED SN BK BX**

**Weidmüller Interface GmbH & Co. KG**  
 Klingenbergstraße 26  
 D-32758 Detmold  
 Germany

www.weidmueller.com

**Technical data**

	Type of conductor and conductor cross-section	H05V-K1.5
Evaluation	passed	

**Important note**

**IPC conformity** Conformity: The products are developed, manufactured and delivered according international recognized standards and norms and comply with the assured properties in the data sheet resp. fulfill decorative properties in accordance with IPC-A-610 "Class 2". Further claims on the products can be evaluated on request.

- Notes**
- Rated data refer only to the component itself. Clearance and creepage distances to other components are to be designed in accordance with the relevant application standards.
  - P on drawing = pitch
  - Crimp form A for wire end ferrules with PZ 6/5 crimping tool are recommended for the largest cable sizes.
  - Total load-carrying capacity of the potential bridges when feeding with 1.5 mm<sup>2</sup> is max. 17.5 A (so the capacity is 2.18 A for poles 2 through 9)
  - Wire end ferrule without plastic collar to DIN 46228/1
  - Wire end ferrule with plastic collar to DIN 46228/4
  - Conductor < 0.2 mm<sup>2</sup> tinned
  - Max. outer diameter of the conductor: 2.9 mm
  - In accordance with IEC 61984, OMNIMATE-connectors are connectors without breaking capacity (COC). During designated use, connectors are not allowed to be engaged or disengaged when live or under load
  - Long term storage of the product with average temperature of 50 °C and maximum humidity 70%, 36 months

**Classifications**

ETIM 8.0	EC002638	ETIM 9.0	EC002638
ETIM 10.0	EC002638	ECLASS 14.0	27-46-02-02
ECLASS 15.0	27-46-02-02		

**BL-I/O 3.50/10F NPN LED SN BK BX**

**Weidmüller Interface GmbH & Co. KG**  
 Klingenbergstraße 26  
 D-32758 Detmold  
 Germany

www.weidmueller.com

Drawings

Dimensional drawing

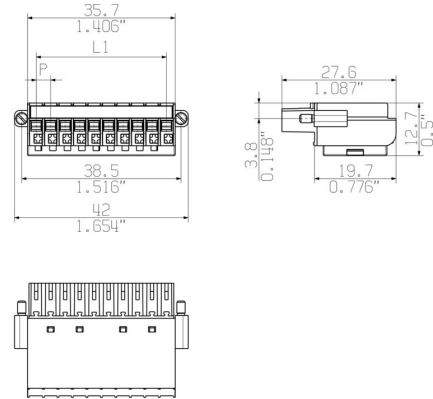

Graph



Graph

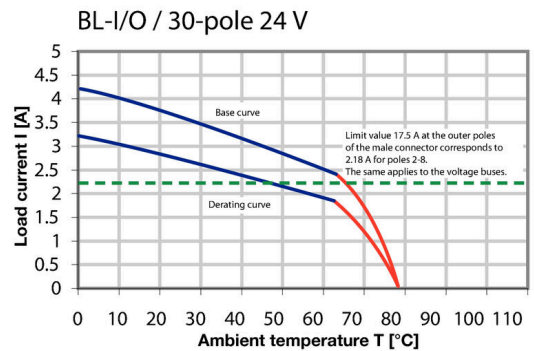

Product benefits



Solid PUSH IN contactSafe and durable

Product benefits



Multiplies the potentialLow wiring costs

**Product benefits**



PUSH IN - fast and secure  
Invented by Weidmüller

**Product benefits**



Integrated electronics  
For more space on the circuit board

## BL-I/O 3.50/10F NPN LED SN BK BX

**Weidmüller Interface GmbH & Co. KG**  
 Klingenbergstraße 26  
 D-32758 Detmold  
 Germany

www.weidmueller.com

## Accessories

### Coding elements



Only connects what is supposed to be connected: the right connection at the right place.  
 Coding elements and locking devices clearly assign connecting elements during the manufacturing process and operation  
 The coding elements and locking devices are inserted prior to assembly or during the cable assembly phase. The Weidmüller alternative: configure online using the variant configurator to precode prior to delivery. Incorrect assembly on the circuit board and incorrect plugging of connecting elements is no longer possible. The advantage: no troubleshooting during manufacture and no operational errors by the user.

### General ordering data

Type	BL SL 3.5 KO OR	Version
Order No.	<a href="#">1693430000</a>	PCB plug-in connector, Accessories, Coding element, orange, Number
GTIN (EAN)	4008190867447	of poles: 1
Qty.	100 ST	
Type	BL SL 3.5 KO SW	Version
Order No.	<a href="#">1610100000</a>	PCB plug-in connector, Accessories, Coding element, black, Number
GTIN (EAN)	4008190187637	of poles: 1
Qty.	100 ST	

### Slotted screwdriver



Slotted screwdriver with rounded blade SD DIN 5265, ISO 2380/2, output to DIN 5264, ISO 2380/1. ChromTop tip, SoftFinish grip

### General ordering data

Type	SDS 0.4X2.5X75	Version
Order No.	<a href="#">9009030000</a>	Screwdriver, Screwdriver
GTIN (EAN)	4032248266944	
Qty.	1 ST	
Type	SDIS 0.4X2.5X75	Version
Order No.	<a href="#">9008370000</a>	Screwdriver, Screwdriver
GTIN (EAN)	4032248056330	
Qty.	1 ST	

## BL-I/O 3.50/10F NPN LED SN BK BX

**Weidmüller Interface GmbH & Co. KG**  
 Klingenbergstraße 26  
 D-32758 Detmold  
 Germany

www.weidmueller.com

## Accessories

### Crimping tools



Crimping tools for wire end ferrules, with and without plastic collars

- Ratchet guarantees precise crimping
- Release option in the event of incorrect operation

### General ordering data

Type	PZ 1.5	Version
Order No.	<a href="#">9005990000</a>	Pressing tool, Crimping tool for wire-end ferrules, 0.14mm <sup>2</sup> , 1.5mm <sup>2</sup> ,
GTIN (EAN)	4008190085964	Trapezoidal crimp
Qty.	1 ST	
Type	PZ 6/5	Version
Order No.	<a href="#">9011460000</a>	Pressing tool, Crimping tool for wire-end ferrules, 0.25mm <sup>2</sup> , 6mm <sup>2</sup> ,
GTIN (EAN)	4008190165352	Trapezoidal indentation crimp
Qty.	1 ST	

## BL-I/O 3.50/10F NPN LED SN BK BX

**Weidmüller Interface GmbH & Co. KG**  
 Klingenbergstraße 26  
 D-32758 Detmold  
 Germany

## Counterpart

www.weidmueller.com

## SLD 3.50/90G



Two-tier pin header for wave soldering in 3.50 mm pitch. The connector is available in open, closed and flange versions. The male connectors provide space for labelling and can be coded. Packed in a cardboard box.

## General ordering data

Type	SLD 3.50/20/90G 3.2SN O...	Version
Order No.	<a href="#">1633660000</a>	PCB plug-in connector, male header, closed side, THT solder
GTIN (EAN)	4008190258115	connection, 3.50 mm, Number of poles: 20, 90°, Solder pin length (l):
Qty.	20 ST	3.2 mm, tinned, orange, Box
Type	SLD 3.50/20/90G 4.5SN B...	Version
Order No.	<a href="#">1634350000</a>	PCB plug-in connector, male header, closed side, THT solder
GTIN (EAN)	4008190258801	connection, 3.50 mm, Number of poles: 20, 90°, Solder pin length (l):
Qty.	20 ST	4.5 mm, tinned, black, Box

## SL 3.50/90G



Pin headers for wave soldering in 3.50 mm pitch

- Plugging direction is parallel (90°), straight 180° or angled (135°) to the PCB
- Housing variant: screw flange (F)
- Packed in a cardboard box (BX)
- Pin header can be coded

## General ordering data

Type	SL 3.50/10/90G 3.2SN BK...	Version
Order No.	<a href="#">1689780000</a>	PCB plug-in connector, male header, closed side, THT solder
GTIN (EAN)	4008190860738	connection, 3.50 mm, Number of poles: 10, 90°, Solder pin length (l):
Qty.	50 ST	3.2 mm, tinned, black, Box

## SL-SMT 3.5/180G Box

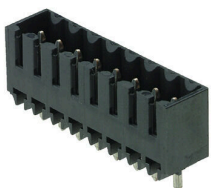

High-temperature-resistant male header, 3.50 mm pitch.

- Plugging direction parallel (90°), straight 180° or angled (135°) to PCB
- Housing variants: closed side (G), screw flange (F), solder flange (LF) or snap-on solder flange (RF)
- Optimised for the SMT process
- Pin length 3.2 mm universal for all soldering methods
- Pin length 1.5 mm optimised for reflow soldering methods
- Packed either in a box (BX) or tape-on-reel (RL)
- Male header can be coded

## BL-I/O 3.50/10F NPN LED SN BK BX

**Weidmüller Interface GmbH & Co. KG**  
 Klingenbergstraße 26  
 D-32758 Detmold  
 Germany

www.weidmueller.com

## Counterpart

### General ordering data

Type	SL-SMT 3.50/10/180G 1.5...	Version
Order No.	<a href="#">1753062001</a>	PCB plug-in connector, male header, closed side, THT/THR solder connection, 3.50 mm, Number of poles: 10, 180°, Solder pin length (l): 1.5 mm, tinned, black, Box
GTIN (EAN)	4032248130962	
Qty.	50 ST	

### SL-SMT 3.50/180 Box

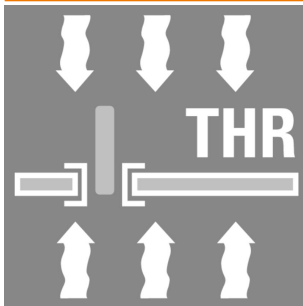

- High-temperature-resistant male header, 3.50 mm pitch.
- Plugging direction parallel (90°), straight 180° or angled (135°) to PCB
  - Housing variants: closed side (G), screw flange (F), solder flange (LF) or snap-on solder flange (RF)
  - Optimised for the SMT process
  - Pin length 3.2 mm universal for all soldering methods
  - Pin length 1.5 mm optimised for reflow soldering methods
  - Packed either in a box (BX) or tape-on-reel (RL)
  - Male header can be coded

### General ordering data

Type	SL-SMT 3.50/10/180 1.5S...	Version
Order No.	<a href="#">1760812001</a>	PCB plug-in connector, male header, open side, THT/THR solder connection, 3.50 mm, Number of poles: 10, 180°, Solder pin length (l): 1.5 mm, tinned, black, Box
GTIN (EAN)	4032248131273	
Qty.	50 ST	

### SL-SMT 3.5/90G Box



- High-temperature-resistant male header, 3.50 mm pitch.
- Plugging direction parallel (90°), straight 180° or angled (135°) to PCB
  - Housing variants: closed side (G), screw flange (F), solder flange (LF) or snap-on solder flange (RF)
  - Optimised for the SMT process
  - Pin length 3.2 mm universal for all soldering methods
  - Pin length 1.5 mm optimised for reflow soldering methods
  - Packed either in a box (BX) or tape-on-reel (RL)
  - Male header can be coded

### General ordering data

Type	SL-SMT 3.50/10/90G 1.5S...	Version
Order No.	<a href="#">1761622001</a>	PCB plug-in connector, male header, closed side, THT/THR solder connection, 3.50 mm, Number of poles: 10, 90°, Solder pin length (l): 1.5 mm, tinned, black, Box
GTIN (EAN)	4032248132218	
Qty.	50 ST	

## BL-I/O 3.50/10F NPN LED SN BK BX

**Weidmüller Interface GmbH & Co. KG**  
 Klingenbergstraße 26  
 D-32758 Detmold  
 Germany

www.weidmueller.com

## Counterpart

## SL-SMT 3.5/90G Tape



- High-temperature-resistant male header, 3.50 mm pitch.
- Plugging direction parallel (90°), straight 180° or angled (135°) to PCB
  - Housing variants: closed side (G), screw flange (F), solder flange (LF) or snap-on solder flange (RF)
  - Optimised for the SMT process
  - Pin length 3.2 mm universal for all soldering methods
  - Pin length 1.5 mm optimised for reflow soldering methods
  - Packed either in a box (BX) or tape-on-reel (RL)
  - Male header can be coded

## General ordering data

Type	SL-SMT 3.50/10/90G 1.5S...	Version
Order No.	<a href="#">1761624001</a>	PCB plug-in connector, male header, closed side, THT/THR solder
GTIN (EAN)	4032248136063	connection, 3.50 mm, Number of poles: 10, 90°, Solder pin length (l):
Qty.	385 ST	1.5 mm, tinned, black, Tape

## SL 3.50/90

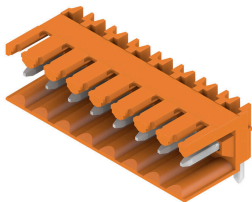

- Pin headers for wave soldering in 3.50 mm pitch
- Plugging direction is parallel (90°), straight 180° or angled (135°) to the PCB
  - Housing variant: screw flange (F)
  - Packed in a cardboard box (BX)
  - Pin header can be coded

## General ordering data

Type	SL 3.50/10/90 3.2SN OR ...	Version
Order No.	<a href="#">1597290000</a>	PCB plug-in connector, male header, open side, THT solder
GTIN (EAN)	4008190165277	connection, 3.50 mm, Number of poles: 10, 90°, Solder pin length (l):
Qty.	50 ST	3.2 mm, tinned, orange, Box

## SL 3.50/180G

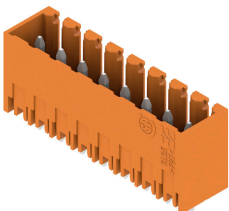

- Pin headers for wave soldering in 3.50 mm pitch
- Plugging direction is parallel (90°), straight 180° or angled (135°) to the PCB
  - Housing variant: screw flange (F)
  - Packed in a cardboard box (BX)
  - Pin header can be coded

## BL-I/O 3.50/10F NPN LED SN BK BX

Weidmüller Interface GmbH & Co. KG  
Klingenbergstraße 26  
D-32758 Detmold  
Germany

www.weidmueller.com

## Counterpart

## General ordering data

Type	SL 3.50/10/180G 3.2SN O...	Version
Order No.	<a href="#">1604550000</a>	PCB plug-in connector, male header, closed side, THT solder
GTIN (EAN)	4008190111663	connection, 3.50 mm, Number of poles: 10, 180°, Solder pin length
Qty.	50 ST	(I): 3.2 mm, tinned, orange, Box
Type	SL 3.50/10/180G 4.5SN O...	Version
Order No.	<a href="#">1604700000</a>	PCB plug-in connector, male header, closed side, THT solder
GTIN (EAN)	4008190058616	connection, 3.50 mm, Number of poles: 10, 180°, Solder pin length
Qty.	50 ST	(I): 4.5 mm, tinned, orange, Box

## SL 3.50/180

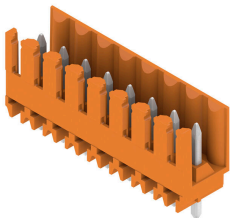

Pin headers for wave soldering in 3.50 mm pitch

- Plugging direction is parallel (90°), straight 180° or angled (135°) to the PCB
- Housing variant: screw flange (F)
- Packed in a cardboard box (BX)
- Pin header can be coded

## General ordering data

Type	SL 3.50/10/180 3.2SN OR...	Version
Order No.	<a href="#">1604850000</a>	PCB plug-in connector, male header, open side, THT solder
GTIN (EAN)	4008190096649	connection, 3.50 mm, Number of poles: 10, 180°, Solder pin length
Qty.	50 ST	(I): 3.2 mm, tinned, orange, Box
Type	SL 3.50/10/180 4.5 SN O...	Version
Order No.	<a href="#">1605000000</a>	PCB plug-in connector, male header, open side, THT solder
GTIN (EAN)	4008190165802	connection, 3.50 mm, Number of poles: 10, 180°, Solder pin length
Qty.	50 ST	(I): 4.5 mm, tinned, orange, Box

## SL 3.50/90G



Pin headers for wave soldering in 3.50 mm pitch

- Plugging direction is parallel (90°), straight 180° or angled (135°) to the PCB
- Housing variant: screw flange (F)
- Packed in a cardboard box (BX)
- Pin header can be coded

## General ordering data

Type	SL 3.50/10/90G 3.2SN OR...	Version
Order No.	<a href="#">1605150000</a>	PCB plug-in connector, male header, closed side, THT solder
GTIN (EAN)	4008190183998	connection, 3.50 mm, Number of poles: 10, 90°, Solder pin length (I):
Qty.	50 ST	3.2 mm, tinned, orange, Box

## BL-I/O 3.50/10F NPN LED SN BK BX

Weidmüller Interface GmbH & Co. KG  
Klingenbergstraße 26  
D-32758 Detmold  
Germany

www.weidmueller.com

## Counterpart

## SL 3.50/90



- Pin headers for wave soldering in 3.50 mm pitch
- Plugging direction is parallel (90°), straight 180° or angled (135°) to the PCB
  - Housing variant: screw flange (F)
  - Packed in a cardboard box (BX)
  - Pin header can be coded

## General ordering data

Type	SL 3.50/10/90 4.5SN OR ...	Version
Order No.	<a href="#">1605450000</a>	PCB plug-in connector, male header, open side, THT solder
GTIN (EAN)	4008190138363	connection, 3.50 mm, Number of poles: 10, 90°, Solder pin length (l):
Qty.	50 ST	4.5 mm, tinned, orange, Box
Type	SL 3.50/10/90 4.5SN BK ...	Version
Order No.	<a href="#">1615360000</a>	PCB plug-in connector, male header, open side, THT solder
GTIN (EAN)	4008190053024	connection, 3.50 mm, Number of poles: 10, 90°, Solder pin length (l):
Qty.	50 ST	4.5 mm, tinned, black, Box

## SL 3.50/90G

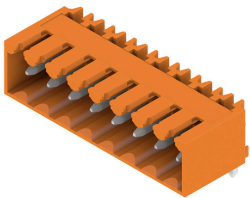

- Pin headers for wave soldering in 3.50 mm pitch
- Plugging direction is parallel (90°), straight 180° or angled (135°) to the PCB
  - Housing variant: screw flange (F)
  - Packed in a cardboard box (BX)
  - Pin header can be coded

## General ordering data

Type	SL 3.50/10/90G 4.5SN BK...	Version
Order No.	<a href="#">1615470000</a>	PCB plug-in connector, male header, closed side, THT solder
GTIN (EAN)	4008190055677	connection, 3.50 mm, Number of poles: 10, 90°, Solder pin length (l):
Qty.	50 ST	4.5 mm, tinned, black, Box

## SL 3.50/180G

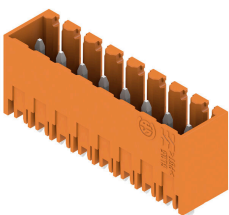

- Pin headers for wave soldering in 3.50 mm pitch
- Plugging direction is parallel (90°), straight 180° or angled (135°) to the PCB
  - Housing variant: screw flange (F)
  - Packed in a cardboard box (BX)
  - Pin header can be coded

## BL-I/O 3.50/10F NPN LED SN BK BX

**Weidmüller Interface GmbH & Co. KG**  
Klingenbergstraße 26  
D-32758 Detmold  
Germany

www.weidmueller.com

## Counterpart

### General ordering data

Type	SL 3.50/10/180G 4.5SN B...	Version
Order No.	<a href="#">1616080000</a>	PCB plug-in connector, male header, closed side, THT solder
GTIN (EAN)	4008190065973	connection, 3.50 mm, Number of poles: 10, 180°, Solder pin length
Qty.	50 ST	(l): 4.5 mm, tinned, black, Box

### SL-SMT 3.5/180G Box



- High-temperature-resistant male header, 3.50 mm pitch.
- Plugging direction parallel (90°), straight 180° or angled (135°) to PCB
  - Housing variants: closed side (G), screw flange (F), solder flange (LF) or snap-on solder flange (RF)
  - Optimised for the SMT process
  - Pin length 3.2 mm universal for all soldering methods
  - Pin length 1.5 mm optimised for reflow soldering methods
  - Packed either in a box (BX) or tape-on-reel (RL)
  - Male header can be coded

### General ordering data

Type	SL-SMT 3.50/10/180G 3.2...	Version
Order No.	<a href="#">1836990000</a>	PCB plug-in connector, male header, closed side, THT/THR solder
GTIN (EAN)	4032248345076	connection, 3.50 mm, Number of poles: 10, 180°, Solder pin length
Qty.	50 ST	(l): 3.2 mm, tinned, black, Box

### SL-SMT 3.5/180LF Box

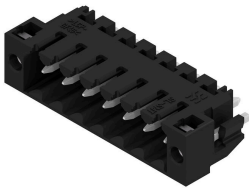

- High-temperature-resistant male header, 3.50 mm pitch.
- Plugging direction parallel (90°), straight 180° or angled (135°) to PCB
  - Housing variants: closed side (G), screw flange (F), solder flange (LF) or snap-on solder flange (RF)
  - Optimised for the SMT process
  - Pin length 3.2 mm universal for all soldering methods
  - Pin length 1.5 mm optimised for reflow soldering methods
  - Packed either in a box (BX) or tape-on-reel (RL)
  - Male header can be coded

### General ordering data

Type	SL-SMT 3.50/10/180LF 1....	Version
Order No.	<a href="#">1804780000</a>	PCB plug-in connector, male header, Solder flange, THT/THR solder
GTIN (EAN)	4032248268566	connection, 3.50 mm, Number of poles: 10, 180°, Solder pin length
Qty.	42 ST	(l): 1.5 mm, tinned, black, Box
Type	SL-SMT 3.50/10/180LF 3....	Version
Order No.	<a href="#">1842620000</a>	PCB plug-in connector, male header, Solder flange, THT/THR solder
GTIN (EAN)	4032248353989	connection, 3.50 mm, Number of poles: 10, 180°, Solder pin length
Qty.	42 ST	(l): 3.2 mm, tinned, black, Box

## BL-I/O 3.50/10F NPN LED SN BK BX

**Weidmüller Interface GmbH & Co. KG**  
 Klingenbergstraße 26  
 D-32758 Detmold  
 Germany

www.weidmueller.com

## Counterpart

## SL-SMT 3.5/90G Box



- High-temperature-resistant male header, 3.50 mm pitch.
- Plugging direction parallel (90°), straight 180° or angled (135°) to PCB
  - Housing variants: closed side (G), screw flange (F), solder flange (LF) or snap-on solder flange (RF)
  - Optimised for the SMT process
  - Pin length 3.2 mm universal for all soldering methods
  - Pin length 1.5 mm optimised for reflow soldering methods
  - Packed either in a box (BX) or tape-on-reel (RL)
  - Male header can be coded

## General ordering data

Type	SL-SMT 3.50/10/90G 3.2S...	Version
Order No.	<a href="#">1841710000</a>	PCB plug-in connector, male header, closed side, THT/THR solder
GTIN (EAN)	4032248353064	connection, 3.50 mm, Number of poles: 10, 90°, Solder pin length (l):
Qty.	50 ST	3.2 mm, tinned, black, Box

## SL-THR 3.5/135F

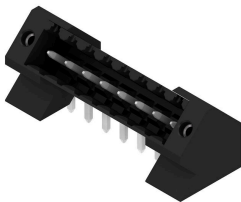

- High-temperature-resistant male header, 3.50 mm pitch.
- Plugging direction parallel (90°), straight 180° or angled (135°) to PCB
  - Housing variants: closed side (G), screw flange (F), solder flange (LF) or snap-on solder flange (RF)
  - Optimised for the SMT process
  - Pin length 3.2 mm universal for all soldering methods
  - Pin length 1.5 mm optimised for reflow soldering methods
  - Packed either in a box (BX) or tape-on-reel (RL)
  - Male header can be coded

## General ordering data

Type	SL-SMT 3.50/10/135F 3.2...	Version
Order No.	<a href="#">1003590000</a>	PCB plug-in connector, male header, Flange, THT/THR solder
GTIN (EAN)	4032248700219	connection, 3.50 mm, Number of poles: 10, 135°, Solder pin length
Qty.	42 ST	(l): 3.2 mm, tinned, black, Box

## SL 3.50/90F

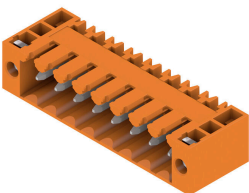

- Pin headers for wave soldering in 3.50 mm pitch
- Plugging direction is parallel (90°), straight 180° or angled (135°) to the PCB
  - Housing variant: screw flange (F)
  - Packed in a cardboard box (BX)
  - Pin header can be coded

## BL-I/O 3.50/10F NPN LED SN BK BX

**Weidmüller Interface GmbH & Co. KG**  
 Klingenbergstraße 26  
 D-32758 Detmold  
 Germany

[www.weidmueller.com](http://www.weidmueller.com)

## Counterpart

### General ordering data

Type	SL 3.50/10/90F 3.2SN DK...	Version
Order No.	<a href="#">1620140000</a>	PCB plug-in connector, male header, Flange, THT solder connection,
GTIN (EAN)	4008190152437	3.50 mm, Number of poles: 10, 90°, Solder pin length (l): 3.2 mm,
Qty.	50 ST	tinned, Signal green, Box

### SLD 3.50/90F



Two-tier pin header for wave soldering in 3.50 mm pitch. The connector is available in open, closed and flange versions. The male connectors provide space for labelling and can be coded. Packed in a cardboard box.

### General ordering data

Type	SLD 3.50/20/90F 3.2SN O...	Version
Order No.	<a href="#">1633890000</a>	PCB plug-in connector, male header, Flange, THT solder connection,
GTIN (EAN)	4008190258344	3.50 mm, Number of poles: 20, 90°, Solder pin length (l): 3.2 mm,
Qty.	20 ST	tinned, orange, Box

### SLD 3.50V/180F

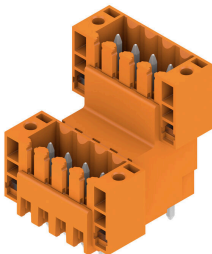

Double-level, staggered pin header for wave soldering at 3.50 mm pitch. They are available in closed and flanged versions. The male connectors provide space for labelling and can be coded.

### General ordering data

Type	SLD 3.50 V/20/180F 3.2 ...	Version
Order No.	<a href="#">1641280000</a>	PCB plug-in connector, male header, Flange, THT solder connection,
GTIN (EAN)	4008190279684	3.50 mm, Number of poles: 20, 180°, Solder pin length (l): 3.2 mm,
Qty.	20 ST	tinned, orange, Box

## BL-I/O 3.50/10F NPN LED SN BK BX

**Weidmüller Interface GmbH & Co. KG**  
 Klingenbergstraße 26  
 D-32758 Detmold  
 Germany

www.weidmueller.com

## Counterpart

## SL 3.50/135F



Pin headers for wave soldering in 3.50 mm pitch

- Plugging direction is parallel (90°), straight 180° or angled (135°) to the PCB
- Housing variant: screw flange (F)
- Packed in a cardboard box (BX)
- Pin header can be coded

## General ordering data

Type	SL 3.50/10/135F 3.2SN O...	Version
Order No.	<a href="#">1643410000</a>	PCB plug-in connector, male header, Flange, THT solder connection,
GTIN (EAN)	4008190282172	3.50 mm, Number of poles: 10, 135°, Solder pin length (l): 3.2 mm,
Qty.	42 ST	tinned, orange, Box

## SL 3.50/90F



Pin headers for wave soldering in 3.50 mm pitch

- Plugging direction is parallel (90°), straight 180° or angled (135°) to the PCB
- Housing variant: screw flange (F)
- Packed in a cardboard box (BX)
- Pin header can be coded

## General ordering data

Type	SL 3.50/10/90F 3.2SN BK...	Version
Order No.	<a href="#">1681720000</a>	PCB plug-in connector, male header, Flange, THT solder connection,
GTIN (EAN)	4008190472528	3.50 mm, Number of poles: 10, 90°, Solder pin length (l): 3.2 mm,
Qty.	50 ST	tinned, black, Box

## SL-SMT 3.5/180G Tape

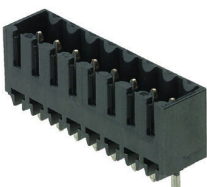

High-temperature-resistant male header, 3.50 mm pitch.

- Plugging direction parallel (90°), straight 180° or angled (135°) to PCB
- Housing variants: closed side (G), screw flange (F), solder flange (LF) or snap-on solder flange (RF)
- Optimised for the SMT process
- Pin length 3.2 mm universal for all soldering methods
- Pin length 1.5 mm optimised for reflow soldering methods
- Packed either in a box (BX) or tape-on-reel (RL)
- Male header can be coded

## BL-I/O 3.50/10F NPN LED SN BK BX

**Weidmüller Interface GmbH & Co. KG**  
 Klingenbergstraße 26  
 D-32758 Detmold  
 Germany

www.weidmueller.com

## Counterpart

### General ordering data

Type	SL-SMT 3.50/10/180G 1.5...	Version
Order No.	<a href="#">1753064001</a>	PCB plug-in connector, male header, closed side, THT/THR solder
GTIN (EAN)	4032248135660	connection, 3.50 mm, Number of poles: 10, 180°, Solder pin length
Qty.	265 ST	(l): 1.5 mm, tinned, black, Tape

### SL-SMT 3.5/180F Box



- High-temperature-resistant male header, 3.50 mm pitch.
- Plugging direction parallel (90°), straight 180° or angled (135°) to PCB
  - Housing variants: closed side (G), screw flange (F), solder flange (LF) or snap-on solder flange (RF)
  - Optimised for the SMT process
  - Pin length 3.2 mm universal for all soldering methods
  - Pin length 1.5 mm optimised for reflow soldering methods
  - Packed either in a box (BX) or tape-on-reel (RL)
  - Male header can be coded

### General ordering data

Type	SL-SMT 3.50/10/180F 1.5...	Version
Order No.	<a href="#">1761042001</a>	PCB plug-in connector, male header, Flange, THT/THR solder
GTIN (EAN)	4032248131617	connection, 3.50 mm, Number of poles: 10, 180°, Solder pin length
Qty.	42 ST	(l): 1.5 mm, tinned, black, Box
Type	SL-SMT 3.50/10/180F 1.5...	Version
Order No.	<a href="#">1761043001</a>	PCB plug-in connector, male header, Flange, THT/THR solder
GTIN (EAN)	4032248133420	connection, 3.50 mm, Number of poles: 10, 180°, Solder pin length
Qty.	36 ST	(l): 1.5 mm, tinned, black, Tray

### SL-SMT 3.5/90F Box

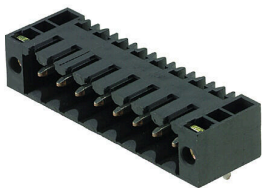

- High-temperature-resistant male header, 3.50 mm pitch.
- Plugging direction parallel (90°), straight 180° or angled (135°) to PCB
  - Housing variants: closed side (G), screw flange (F), solder flange (LF) or snap-on solder flange (RF)
  - Optimised for the SMT process
  - Pin length 3.2 mm universal for all soldering methods
  - Pin length 1.5 mm optimised for reflow soldering methods
  - Packed either in a box (BX) or tape-on-reel (RL)
  - Male header can be coded

### General ordering data

Type	SL-SMT 3.50/10/90F 1.5S...	Version
Order No.	<a href="#">1762082001</a>	PCB plug-in connector, male header, Flange, THT/THR solder
GTIN (EAN)	4032248132492	connection, 3.50 mm, Number of poles: 10, 90°, Solder pin length (l):
Qty.	42 ST	1.5 mm, tinned, black, Box

## BL-I/O 3.50/10F NPN LED SN BK BX

**Weidmüller Interface GmbH & Co. KG**  
 Klingenbergstraße 26  
 D-32758 Detmold  
 Germany

www.weidmueller.com

## Counterpart

## SL 3.50/90F



Pin headers for wave soldering in 3.50 mm pitch

- Plugging direction is parallel (90°), straight 180° or angled (135°) to the PCB
- Housing variant: screw flange (F)
- Packed in a cardboard box (BX)
- Pin header can be coded

## General ordering data

Type	SL 3.50/10/90F 3.2SN OR...	Version
Order No.	<a href="#">1607120000</a>	PCB plug-in connector, male header, Flange, THT solder connection,
GTIN (EAN)	4008190079710	3.50 mm, Number of poles: 10, 90°, Solder pin length (l): 3.2 mm,
Qty.	50 ST	tinned, orange, Box

## SL 3.50/180F

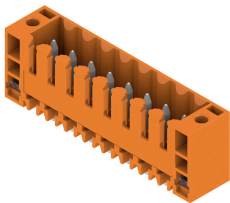

Pin headers for wave soldering in 3.50 mm pitch

- Plugging direction is parallel (90°), straight 180° or angled (135°) to the PCB
- Housing variant: screw flange (F)
- Packed in a cardboard box (BX)
- Pin header can be coded

## General ordering data

Type	SL 3.50/10/180F 3.2SN O...	Version
Order No.	<a href="#">1607580000</a>	PCB plug-in connector, male header, Flange, THT solder connection,
GTIN (EAN)	4008190187545	3.50 mm, Number of poles: 10, 180°, Solder pin length (l): 3.2 mm,
Qty.	50 ST	tinned, orange, Box

## SL 3.50/90F



Pin headers for wave soldering in 3.50 mm pitch

- Plugging direction is parallel (90°), straight 180° or angled (135°) to the PCB
- Housing variant: screw flange (F)
- Packed in a cardboard box (BX)
- Pin header can be coded

## General ordering data

Type	SL 3.50/10/90F 4.5 SN B...	Version
Order No.	<a href="#">1615600000</a>	PCB plug-in connector, male header, Flange, THT solder connection,
GTIN (EAN)	4008190057633	3.50 mm, Number of poles: 10, 90°, Solder pin length (l): 4.5 mm,
Qty.	50 ST	tinned, black, Box

## BL-I/O 3.50/10F NPN LED SN BK BX

**Weidmüller Interface GmbH & Co. KG**  
 Klingenbergstraße 26  
 D-32758 Detmold  
 Germany

www.weidmueller.com

## Counterpart

### SL 3.50/180F



Pin headers for wave soldering in 3.50 mm pitch

- Plugging direction is parallel (90°), straight 180° or angled (135°) to the PCB
- Housing variant: screw flange (F)
- Packed in a cardboard box (BX)
- Pin header can be coded

### General ordering data

Type	SL 3.50/10/180F 4.5 SN ...	Version
Order No.	<a href="#">1616210000</a>	PCB plug-in connector, male header, Flange, THT solder connection,
GTIN (EAN)	4008190068929	3.50 mm, Number of poles: 10, 180°, Solder pin length (l): 4.5 mm,
Qty.	50 ST	tinned, black, Box

### SL-SMT 3.5/90LF Box

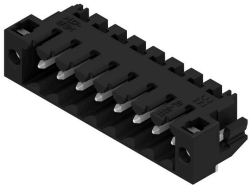

High-temperature-resistant male header, 3.50 mm pitch.

- Plugging direction parallel (90°), straight 180° or angled (135°) to PCB
- Housing variants: closed side (G), screw flange (F), solder flange (LF) or snap-on solder flange (RF)
- Optimised for the SMT process
- Pin length 3.2 mm universal for all soldering methods
- Pin length 1.5 mm optimised for reflow soldering methods
- Packed either in a box (BX) or tape-on-reel (RL)
- Male header can be coded

### General ordering data

Type	SL-SMT 3.50/10/90LF 3.2...	Version
Order No.	<a href="#">1841940000</a>	PCB plug-in connector, male header, Solder flange, THT/THR solder
GTIN (EAN)	4032248353293	connection, 3.50 mm, Number of poles: 10, 90°, Solder pin length (l):
Qty.	42 ST	3.2 mm, tinned, black, Box
Type	SL-SMT 3.50/10/90LF 1.5...	Version
Order No.	<a href="#">1805020000</a>	PCB plug-in connector, male header, Solder flange, THT/THR solder
GTIN (EAN)	4032248268924	connection, 3.50 mm, Number of poles: 10, 90°, Solder pin length (l):
Qty.	42 ST	1.5 mm, tinned, black, Box

## BL-I/O 3.50/10F NPN LED SN BK BX

**Weidmüller Interface GmbH & Co. KG**  
 Klingenbergstraße 26  
 D-32758 Detmold  
 Germany

www.weidmueller.com

## Counterpart

## SL-SMT 3.5/180F Box



- High-temperature-resistant male header, 3.50 mm pitch.
- Plugging direction parallel (90°), straight 180° or angled (135°) to PCB
  - Housing variants: closed side (G), screw flange (F), solder flange (LF) or snap-on solder flange (RF)
  - Optimised for the SMT process
  - Pin length 3.2 mm universal for all soldering methods
  - Pin length 1.5 mm optimised for reflow soldering methods
  - Packed either in a box (BX) or tape-on-reel (RL)
  - Male header can be coded

## General ordering data

Type	SL-SMT 3.50/10/180F 3.2...	Version
Order No.	<a href="#">1842850000</a>	PCB plug-in connector, male header, Flange, THT/THR solder
GTIN (EAN)	4032248354313	connection, 3.50 mm, Number of poles: 10, 180°, Solder pin length
Qty.	42 ST	(I): 3.2 mm, tinned, black, Box

## SL-SMT 3.5/90F Box



- High-temperature-resistant male header, 3.50 mm pitch.
- Plugging direction parallel (90°), straight 180° or angled (135°) to PCB
  - Housing variants: closed side (G), screw flange (F), solder flange (LF) or snap-on solder flange (RF)
  - Optimised for the SMT process
  - Pin length 3.2 mm universal for all soldering methods
  - Pin length 1.5 mm optimised for reflow soldering methods
  - Packed either in a box (BX) or tape-on-reel (RL)
  - Male header can be coded

## General ordering data

Type	SL-SMT 3.50/10/90F 3.2S...	Version
Order No.	<a href="#">1842160000</a>	PCB plug-in connector, male header, Flange, THT/THR solder
GTIN (EAN)	4032248353514	connection, 3.50 mm, Number of poles: 10, 90°, Solder pin length (I):
Qty.	42 ST	3.2 mm, tinned, black, Box

## SL-SMT 3.5/90LF Tape



- High-temperature-resistant male header, 3.50 mm pitch.
- Plugging direction parallel (90°), straight 180° or angled (135°) to PCB
  - Housing variants: closed side (G), screw flange (F), solder flange (LF) or snap-on solder flange (RF)
  - Optimised for the SMT process
  - Pin length 3.2 mm universal for all soldering methods
  - Pin length 1.5 mm optimised for reflow soldering methods
  - Packed either in a box (BX) or tape-on-reel (RL)
  - Male header can be coded

## BL-I/O 3.50/10F NPN LED SN BK BX

**Weidmüller Interface GmbH & Co. KG**  
Klingenbergstraße 26  
D-32758 Detmold  
Germany

## Counterpart

[www.weidmueller.com](http://www.weidmueller.com)

### General ordering data

Type	SL-SMT 3.50/10/90LF 1.5...	Version	
Order No.	<a href="#">1005180000</a>	PCB plug-in connector, male header, Solder flange, THT/THR solder	
GTIN (EAN)	4032248704545	connection, 3.50 mm, Number of poles: 10, 90°, Solder pin length (l):	
Qty.	385 ST	1.5 mm, tinned, black, Tape	