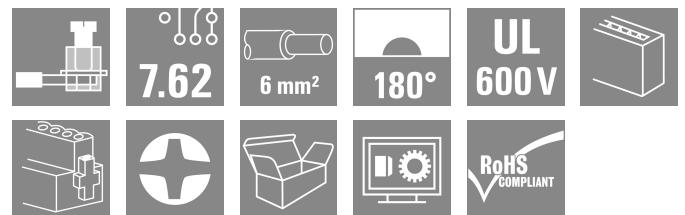
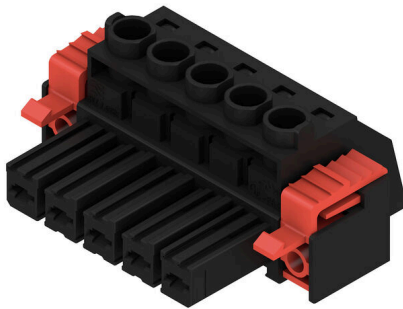

BVZ 7.62HP/05/180F SN BK BX
Weidmüller Interface GmbH & Co. KG

Klingenbergstraße 26

D-32758 Detmold

Germany

www.weidmueller.com
Product image

High-performance female header with the proven, 100% maintenance-free Weidmüller steel clamping yoke. Side-by-side mounting without sacrificing any poles or with patented multifunction flange for secure, fast fixing without tools. Maximum operating reliability thanks to a mating profile that prevents incorrect connection, unique coding diversity, protection against faulty wiring, 4-point contact. Suitable for labelling.

General ordering data

Version	PCB plug-in connector, female plug, 7.62 mm, Number of poles: 5, 180°, Clamping yoke connection, Clamping range, max. : 10 mm ² , Box
Order No.	1930080000
Type	BVZ 7.62HP/05/180F SN BK BX
GTIN (EAN)	4032248579853
Qty.	50 items
Product data	IEC: 1000 V / 57 A / 0.2 - 10 mm ² UL: 600 V / 40.5 A / AWG 24 - AWG 8
Packaging	Box

BVZ 7.62HP/05/180F SN BK BX

Weidmüller Interface GmbH & Co. KG
Klingenbergstraße 26
D-32758 Detmold
Germany

www.weidmueller.com

Technical data

Approvals

Approvals



ROHS Conform

UL File Number Search [UL Website](#)

Certificate No. (cURus) E60693

Dimensions and weights

Depth	42.1 mm	Depth (inches)	1.6575 inch
Height	23.1 mm	Height (inches)	0.9094 inch
Width	53.34 mm	Width (inches)	2.1 inch
Net weight	26.03 g		

Environmental Product Compliance

RoHS Compliance Status Compliant without exemption

REACH SVHC No SVHC above 0.1 wt%

System Parameters

Product family	OMNIMATE Power - series BV/SV 7.62HP	Type of connection	Field connection
Wire connection method	Clamping yoke connection	Pitch in mm (P)	7.62 mm
Pitch in inches (P)	0.300 "	Conductor outlet direction	180°
Number of poles	5	L1 in mm	30.48 mm
L1 in inches	1.200 "	Number of rows	1
Pin series quantity	1	Rated cross-section	6 mm ²
Touch-safe protection acc. to DIN VDE 57 106	Safe from finger touch	Touch-safe protection acc. to DIN VDE 0470	IP 20
Protection degree	IP20	Volume resistance	4.50 mΩ
Can be coded	Yes	Stripping length	12 mm
Tightening torque, min.	0.5 Nm	Tightening torque, max.	0.6 Nm
Clamping screw	M 3	Screwdriver blade	0.6 x 3.5
Plugging cycles	25	Plugging force/pole, max.	16.5 N
Pulling force/pole, max.	11 N		

Material data

Insulating material	PA GF	Colour	black
Colour chart (similar)	RAL 9011	Insulating material group	II
Comparative Tracking Index (CTI)	≥ 500	Moisture Level (MSL)	
UL 94 flammability rating	V-0	Contact base material	Copper alloy
Contact material	Copper alloy	Contact surface	tinned
Layer structure of plug contact	6...8 μm Sn glossy	Storage temperature, min.	-40 °C
Storage temperature, max.	70 °C	Operating temperature, min.	-50 °C
Operating temperature, max.	125 °C	Temperature range, installation, min.	-25 °C
Temperature range, installation, max.	100 °C		

Conductors suitable for connection

Clamping range, min.	0.2 mm ²
Clamping range, max.	10 mm ²

BVZ 7.62HP/05/180F SN BK BX

Weidmüller Interface GmbH & Co. KG

Klingenbergstraße 26
D-32758 Detmold
Germany

www.weidmueller.com

Technical data

Wire connection cross section AWG, min.	AWG 24		
Wire connection cross section AWG, max.	AWG 8		
Solid, min. H05(07) V-U	0.2 mm ²		
Solid, max. H05(07) V-U	6 mm ²		
Flexible, min. H05(07) V-K	0.2 mm ²		
Flexible, max. H05(07) V-K	10 mm ²		
w. plastic collar ferrule, DIN 46228 pt 4, 0.2 mm ² min.			
w. plastic collar ferrule, DIN 46228 pt 4, 6 mm ² max.			
w. wire end ferrule, DIN 46228 pt 1, min.	0.5 mm ²		
w. wire end ferrule, DIN 46228 pt 1, max.	6 mm ²		
Plug gauge in accordance with EN 60999 a x b; ø	2.8 mm x 2.0 mm; 2.4 mm		
Clampable conductor	Cross-section for conductor connection	Type	fine-wired
		nominal	0.5 mm ²
wire end ferrule		Stripping length	nominal 14 mm
		Recommended wire-end ferrule	H0.5/18 OR
Clampable conductor	Cross-section for conductor connection	Type	fine-wired
		nominal	1 mm ²
wire end ferrule		Stripping length	nominal 15 mm
		Recommended wire-end ferrule	H1.0/18 GE
Clampable conductor	Cross-section for conductor connection	Type	fine-wired
		nominal	1.5 mm ²
wire end ferrule		Stripping length	nominal 15 mm
		Recommended wire-end ferrule	H1.5/18D SW
		Stripping length	nominal 12 mm
		Recommended wire-end ferrule	H1.5/12
Clampable conductor	Cross-section for conductor connection	Type	fine-wired
		nominal	0.75 mm ²
wire end ferrule		Stripping length	nominal 14 mm
		Recommended wire-end ferrule	H0.75/18 W
Clampable conductor	Cross-section for conductor connection	Type	fine-wired
		nominal	2.5 mm ²
wire end ferrule		Stripping length	nominal 14 mm
		Recommended wire-end ferrule	H2.5/19D BL
		Stripping length	nominal 12 mm
		Recommended wire-end ferrule	H2.5/12
Clampable conductor	Cross-section for conductor connection	Type	fine-wired
		nominal	4 mm ²
wire end ferrule		Stripping length	nominal 12 mm
		Recommended wire-end ferrule	H4.0/12
		Stripping length	nominal 14 mm
		Recommended wire-end ferrule	H4.0/20D GR
Clampable conductor	Cross-section for conductor connection	Type	fine-wired
		nominal	6 mm ²
wire end ferrule		Stripping length	nominal 14 mm

BVZ 7.62HP/05/180F SN BK BX

Weidmüller Interface GmbH & Co. KG
 Klingenbergstraße 26
 D-32758 Detmold
 Germany

www.weidmueller.com

Technical data

Recommended wire-end ferrule	H6,0/20 SW	
Stripping length	nominal	12 mm
Recommended wire-end ferrule	H6,0/12	

Reference text The outside diameter of the plastic collar should not be larger than the pitch (P), Length of ferrules is to be chosen depending on the product and the rated voltage.

Rated data acc. to IEC

tested acc. to standard	IEC 60664-1, IEC 61984	Rated current, min. number of poles (Tu=20°C)	57 A
Rated current, max. number of poles (Tu=20°C)	54 A	Rated current, min. number of poles (Tu=40°C)	51 A
Rated current, max. number of poles (Tu=40°C)	41 A	Rated voltage for surge voltage class / pollution degree II/2	1000 V
Rated voltage for surge voltage class / pollution degree III/2	1000 V	Rated voltage for surge voltage class / pollution degree III/3	800 V
Rated impulse voltage for surge voltage class/ pollution degree II/2	6000 V	Rated impulse voltage for surge voltage class/ pollution degree III/2	8 kV
Rated impulse voltage for surge voltage class/ contamination degree III/3	8 kV	Short-time withstand current resistance	3 x 1s with 420 A
Creepage distance, min.	13.8 mm	Clearance, min.	10.2 mm

Rated data acc. to CSA

Institute (CSA)	CSA	Certificate No. (CSA)	200039-1534443
Rated voltage (Use group B / CSA)	600 V	Rated voltage (Use group C / CSA)	600 V
Rated voltage (Use group D / CSA)	600 V	Rated current (Use group B / CSA)	40.5 A
Rated current (Use group C / CSA)	40.5 A	Rated current (Use group D / CSA)	5 A
Wire cross-section, AWG, min.	AWG 24	Wire cross-section, AWG, max.	AWG 8
Reference to approval values	Specifications are maximum values, details - see approval certificate.		

Rated data acc. to UL 1059

Institute (cURus)	CURUS	Certificate No. (cURus)	E60693
Rated voltage (Use group B / UL 1059)	600 V	Rated voltage (Use group C / UL 1059)	600 V
Rated voltage (Use group D / UL 1059)	600 V	Rated voltage (Use group F / UL 1059)	1000 V
Rated current (Use group B / UL 1059)	40.5 A	Rated current (Use group C / UL 1059)	40.5 A
Rated current (Use group D / UL 1059)	5 A	Rated current (Use group F / UL 1059)	40.5 A
Wire cross-section, AWG, min.	AWG 24	Wire cross-section, AWG, max.	AWG 8
Reference to approval values	Specifications are maximum values, details - see approval certificate.		

Packing

Packaging	Box	VPE length	335.00 mm
VPE width	147.00 mm	VPE height	89.00 mm

Type tests

Test: Durability of markings	Standard	DIN EN 61984 section 7.3.2 / 09.02 taking pattern from DIN EN 60068-2-70 / 07.96
	Test	mark of origin, type identification, pitch, type of material
	Evaluation	available
	Test	durability

BVZ 7.62HP/05/180F SN BK BX

Weidmüller Interface GmbH & Co. KG
 Klingenbergstraße 26
 D-32758 Detmold
 Germany

www.weidmueller.com

Technical data

Test: Misengagement (Non-interchangeability)	Evaluation	passed		
	Standard	DIN EN 6 1984 section 6.3 and 6.9.1 / 09.02, DIN IEC 5 12 part 7 section 5 / 05.94		
	Test	180° turned with coding elements		
	Evaluation	passed		
Test: Clampable cross section	Test	180° turned without coding elements		
	Evaluation	passed		
	Standard	DIN EN 60999-1 section 7 and 9.1 / 12.00, DIN EN 60947-1 section 8.2.4.5.1 / 12.02		
	Conductor type	Type of conductor and conductor cross-section	solid 0.5 mm ²	
		Type of conductor and conductor cross-section	stranded 0.5 mm ²	
		Type of conductor and conductor cross-section	solid 6 mm ²	
		Type of conductor and conductor cross-section	stranded 6 mm ²	
		Type of conductor and conductor cross-section	AWG 24/1	
		Type of conductor and conductor cross-section	AWG 24/19	
		Type of conductor and conductor cross-section	AWG 10/1	
		Type of conductor and conductor cross-section	AWG 10/19	
	Evaluation	passed		
	Test for damage to and accidental loosening of conductors	Standard	DIN EN 60999-1 section 9.4 / 12.00	
Requirement		0.2 kg		
Conductor type		Type of conductor and conductor cross-section	AWG 24/1	
		Type of conductor and conductor cross-section	AWG 24/19	
Evaluation		passed		
Requirement		0.3 kg		
Conductor type		Type of conductor and conductor cross-section	solid 0.5 mm ²	
		Type of conductor and conductor cross-section	stranded 0.5 mm ²	
Evaluation		passed		
Requirement		1.4 kg		
Conductor type	Type of conductor and conductor cross-section	solid 6 mm ²		
	Type of conductor and conductor cross-section	stranded 6 mm ²		
	Type of conductor and conductor cross-section	AWG 10/1		

BVZ 7.62HP/05/180F SN BK BX

Weidmüller Interface GmbH & Co. KG
 Klingenbergstraße 26
 D-32758 Detmold
 Germany

www.weidmueller.com

Technical data

		Type of conductor and conductor cross-section	AWG 10/19	
Pull-out test	Evaluation	passed		
	Standard	DIN EN 60999-1 section 9.5 / 12.00		
	Requirement	≥10 N		
	Conductor type	Type of conductor and conductor cross-section	AWG 24/1	
		Type of conductor and conductor cross-section	AWG 24/19	
	Evaluation	passed		
	Requirement	≥20 N		
	Conductor type	Type of conductor and conductor cross-section	solid 0.5 mm ²	
		Type of conductor and conductor cross-section	stranded 0.5 mm ²	
	Evaluation	passed		
	Requirement	≥80 N		
	Conductor type	Type of conductor and conductor cross-section	solid 6 mm ²	
		Type of conductor and conductor cross-section	stranded 6 mm ²	
		Type of conductor and conductor cross-section	AWG 10/1	
Type of conductor and conductor cross-section		AWG 10/19		
Evaluation	passed			

Important note

IPC conformity Conformity: The products are developed, manufactured and delivered according international recognized standards and norms and comply with the assured properties in the data sheet resp. fulfill decorative properties in accordance with IPC-A-610 "Class 2". Further claims on the products can be evaluated on request.

- Notes**
- Additional variants on request
 - Rated current related to rated cross-section & min. No. of poles.
 - Wire end ferrule with plastic collar to DIN 46228/4
 - Wire end ferrule without plastic collar to DIN 46228/1
 - P on drawing = pitch
 - Rated data refer only to the component itself. Clearance and creepage distances to other components are to be designed in accordance with the relevant application standards.
 - In accordance with IEC 61984, OMNIMATE-connectors are connectors without breaking capacity (COC). During designated use, connectors are not allowed to be engaged or disengaged when live or under load
 - Long term storage of the product with average temperature of 50 °C and maximum humidity 70%, 36 months

Classifications

ETIM 8.0	EC002638	ETIM 9.0	EC002638
ETIM 10.0	EC002638	ECLASS 14.0	27-46-02-02
ECLASS 15.0	27-46-02-02		

BVZ 7.62HP/05/180F SN BK BX

Weidmüller Interface GmbH & Co. KG
 Klingenbergstraße 26
 D-32758 Detmold
 Germany

www.weidmueller.com

Drawings

Product image

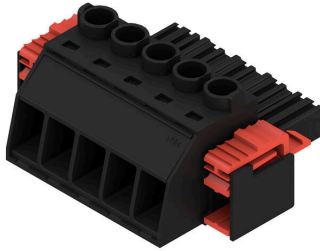

Dimensional drawing

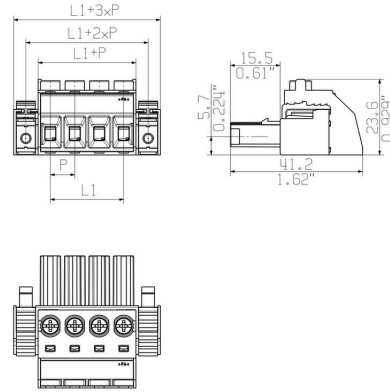

Graph

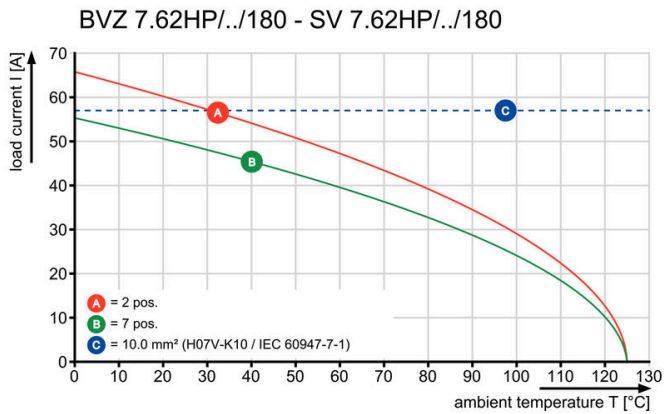

Graph

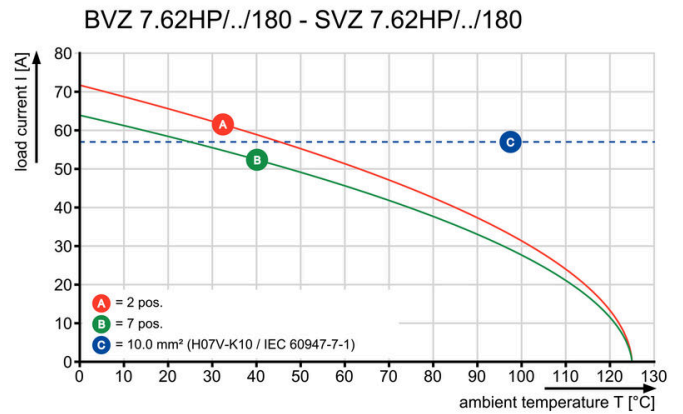

BVZ 7.62HP/05/180F SN BK BX

Weidmüller Interface GmbH & Co. KG
 Klingenbergstraße 26
 D-32758 Detmold
 Germany

www.weidmueller.com

Accessories

Coding elements



The pluggable connections for power electronics - optimised for modern drive technologies, e.g. motor starters, frequency converters and servo-controllers. OMNIMATE Power sets the new standard – with increased safety and innovative solutions such as the pluggable shield, integrated signal contacts and one-handed operation.

The three product lines offer you further advantages:

- Application-oriented scalability: from the compact 4 mm² connector for 29 A (IEC) or 20 A (UL) up to the sturdy 16 mm² connector for 76 A (IEC) or 54 A (UL)
- Unlimited usage up to 1,000 V (IEC) or 600 V (UL)
- A variety of application optimised mounting options

Our service:

Design your individual connectors simply by using the product configurator.

General ordering data

Type	BV/SV 7.62HP KO RD 2022	Version	
Order No.	2007300000	PCB plug-in connector, Accessories, Coding element, red, Number of	
GTIN (EAN)	4050118392715	poles: 1	
Qty.	20 ST		

Strain reliefs



For frequent load changes: the "trailer coupling" for plug-in connectors.

The strain relief can do more than just relieve the strain on conductors:

Simply clip onto the plug and

- bundle conductors
- guide cables
- use as a connection and disconnection aid

No damage to the connecting points, clear, tidy wiring and easy to handle.

User advantages: permanent heavy-duty connections for harsh industrial environments and convenient operation ensure improved system availability.

General ordering data

Type	BV/SV 7.62HP/02 ZE GR	Version	
Order No.	1937550000	PCB plug-in connector, Accessories, Strain relief, Light Grey, Number	
GTIN (EAN)	4032248608836	of poles: 2	
Qty.	50 ST		
Type	BV/SV 7.62HP/04 ZE GR	Version	
Order No.	1937560000	PCB plug-in connector, Accessories, Strain relief, Light Grey, Number	
GTIN (EAN)	4032248608843	of poles: 4	
Qty.	50 ST		

BVZ 7.62HP/05/180F SN BK BX

Weidmüller Interface GmbH & Co. KG
 Klingenbergstraße 26
 D-32758 Detmold
 Germany

www.weidmueller.com

Accessories

Adapters for rail mounting



The pluggable connections for power electronics - optimised for modern drive technologies, e.g. motor starters, frequency converters and servo-controllers. OMNIMATE Power sets the new standard – with increased safety and innovative solutions such as the pluggable shield, integrated signal contacts and one-handed operation.

The three product lines offer you further advantages:

- Application-oriented scalability: from the compact 4 mm² connector for 29 A (IEC) or 20 A (UL) up to the sturdy 16 mm² connector for 76 A (IEC) or 54 A (UL)
- Unlimited usage up to 1,000 V (IEC) or 600 V (UL)
- A variety of application optimised mounting options

Our service:

Design your individual connectors simply by using the product configurator.

General ordering data

Type	BV/SV 7.62HP/02 ARPL GR	Version
Order No.	1937570000	PCB plug-in connector, Accessories, Mounting plate, grey, Number of
GTIN (EAN)	4032248608850	poles: 2
Qty.	50 ST	
Type	BV/SV 7.62HP/04 ARPL GR	Version
Order No.	1937580000	PCB plug-in connector, Accessories, Mounting plate, grey, Number of
GTIN (EAN)	4032248608867	poles: 4
Qty.	50 ST	
Type	BV/SV7.62HP MOFU GR	Version
Order No.	1937600000	PCB plug-in connector, Accessories, Mounting foot, Light Grey
GTIN (EAN)	4032248608898	
Qty.	100 ST	

Slotted screwdriver



Slotted screwdriver with rounded blade SD DIN 5265, ISO 2380/2, output to DIN 5264, ISO 2380/1. ChromTop tip, SoftFinish grip

General ordering data

Type	SDS 0.8X4.5X125	Version
Order No.	9009020000	Screwdriver, Screwdriver
GTIN (EAN)	4032248266883	
Qty.	1 ST	
Type	SDIS 0.8X4.0X100	Version
Order No.	9008400000	Screwdriver, Screwdriver
GTIN (EAN)	4032248056361	
Qty.	1 ST	

BVZ 7.62HP/05/180F SN BK BX

Weidmüller Interface GmbH & Co. KG
 Klingenbergstraße 26
 D-32758 Detmold
 Germany

www.weidmueller.com

Accessories
Crosshead screwdriver Phillips

Crosshead screwdriver, Phillips, SDK PH DIN 5262, ISO 8764/2-PH, output to ISO 8764-PH, ChromTop tip, SoftFinish grip

General ordering data

Type	SDK PH1	Version	
Order No.	9008480000	Screwdriver, Screwdriver	
GTIN (EAN)	4032248056477		
Qty.	1 ST		
Type	SDIK PH1	Version	
Order No.	9008570000	Screwdriver, Screwdriver	
GTIN (EAN)	4032248056569		
Qty.	1 ST		

Crimping tools

Crimping tools for wire end ferrules, with and without plastic collars

- Ratchet guarantees precise crimping
- Release option in the event of incorrect operation

General ordering data

Type	PZ 6/5	Version	
Order No.	9011460000	Pressing tool, Crimping tool for wire-end ferrules, 0.25mm ² , 6mm ² ,	
GTIN (EAN)	4008190165352	Trapezoidal indentation crimp	
Qty.	1 ST		

BVZ 7.62HP/05/180F SN BK BX

Weidmüller Interface GmbH & Co. KG
 Klingenbergstraße 26
 D-32758 Detmold
 Germany

www.weidmueller.com

Counterpart

SV 7.62HP 180F SN

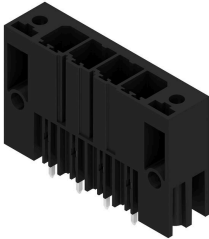

Single-row, high-performance male header for side-by-side mounting without sacrificing any poles or with patented flange for fast fixing without tools. Maximum connection and operating reliability thanks to a mating profile that prevents incorrect connection, with unique coding diversity and additional fastening in the flange. 3.5 mm pin length is optimised for lead-free wave soldering.

General ordering data

Type	SV 7.62HP/05/180F 3.5SN...	Version
Order No.	1930740000	PCB plug-in connector, male header, Clip-on flange, THT solder
GTIN (EAN)	4032248580712	connection, 7.62 mm, Number of poles: 5, 180°, Solder pin length (l):
Qty.	30 ST	3.5 mm, tinned, black, Box

SV 7.62HP 270F SN

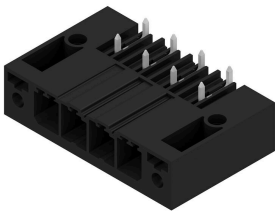

Single-row, high-current and high-performance male headers for side-by-side mounting without sacrificing any poles or with flange for fast fixing without tools. Maximum connection and operating reliability thanks to a mating profile that prevents incorrect connection, unique coding diversity and additional fastening in the flange.

General ordering data

Type	SV 7.62HP/05/270F 3.5SN...	Version
Order No.	1931400000	PCB plug-in connector, male header, Clip-on flange, THT solder
GTIN (EAN)	4032248581436	connection, 7.62 mm, Number of poles: 5, 270°, Solder pin length (l):
Qty.	30 ST	3.5 mm, tinned, black, Box

SV 7.62HP 90F SN

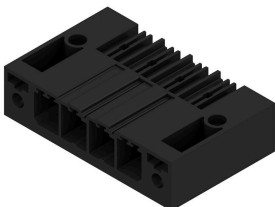

Single-row, high-current and high-performance male headers for side-by-side mounting without sacrificing any poles or with flange for fast fixing without tools. Maximum connection and operating reliability thanks to a mating profile that prevents incorrect connection, unique coding diversity and additional fastening in the flange.

General ordering data

Type	SV 7.62HP/05/90F 3.5SN ...	Version
Order No.	1930410000	PCB plug-in connector, male header, Clip-on flange, THT solder
GTIN (EAN)	4032248580286	connection, 7.62 mm, Number of poles: 5, 90°, Solder pin length (l):
Qty.	30 ST	3.5 mm, tinned, black, Box

BVZ 7.62HP/05/180F SN BK BX

Weidmüller Interface GmbH & Co. KG
 Klingenbergstraße 26
 D-32758 Detmold
 Germany

www.weidmueller.com

Counterpart

SVD 7.62HP 270F SN

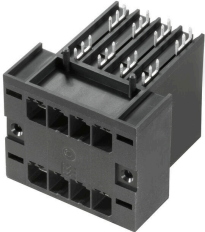

Double-row high-current, high-performance pin headers, with or without flange, for fast, tool-free locking. Optimised for "book-size modules" measuring 50mm wide and above. With integrated mounting option for mounting to the housing wall. Exceptional reliability and operational safety thanks to 100% failsafe mating profile, unique coding and optional additional screw mounting in the flange.

General ordering data

Type	SVD 7.62HP/10/270F 3.2S...	Version
Order No.	1523980000	PCB plug-in connector, male header, Clip-on flange, THT solder
GTIN (EAN)	4050118329759	connection, 7.62 mm, Number of poles: 10, 270°, Solder pin length
Qty.	18 ST	(l): 3.2 mm, tinned, black, Box

SV-SMT 7.62HP 270F BX

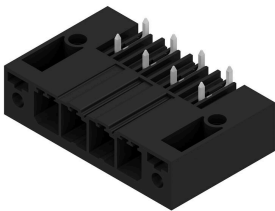

OMNIMATE Power BV / SV 7.62HP – the 28 kVA performance class
 Tailor-made solutions for high performers
 More power reserves for higher load bearing capacity:
 The OMNIMATE Power BV / SV 7.62HP is the middle-class of the power connector systems. It has a large clamping capacity, high overload resistance and the largest range of variants and accessories to choose from: the high performer of the HP range. HP means High Performance – this performance covers a great deal: the full rated current up to 50°C without derating, unlimited 600-V approval according to UL, and the additional finger safety for 400 V-TN systems (+ 3.0 mm) in compliance with the application directive IEC 61800-5-1.

General ordering data

Type	SV-SMT 7.62HP/05/270F 2...	Version
Order No.	2499930000	PCB plug-in connector, male header, Flange, THT/THR solder
GTIN (EAN)	4050118513356	connection, 7.62 mm, Number of poles: 5, 270°, Solder pin length (l):
Qty.	50 ST	2.6 mm, tinned, black, Box
Type	SV-SMT 7.62HP/05/270F 3...	Version
Order No.	2498880000	PCB plug-in connector, male header, Flange, THT/THR solder
GTIN (EAN)	4050118512014	connection, 7.62 mm, Number of poles: 5, 270°, Solder pin length (l):
Qty.	50 ST	3.5 mm, tinned, black, Box

BVZ 7.62HP/05/180F SN BK BX

Weidmüller Interface GmbH & Co. KG
 Klingenbergstraße 26
 D-32758 Detmold
 Germany

Counterpart

www.weidmueller.com

SV-SMT 7.62HP 90F BX

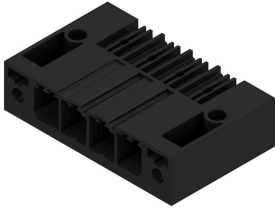

OMNIMATE Power BV / SV 7.62HP – the 28 kVA performance class

Tailor-made solutions for high performers

More power reserves for higher load bearing capacity: The OMNIMATE Power BV / SV 7.62HP is the middle-class of the power connector systems. It has a large clamping capacity, high overload resistance and the largest range of variants and accessories to choose from: the high performer of the HP range. HP means High Performance – this performance covers a great deal: the full rated current up to 50°C without derating, unlimited 600-V approval according to UL, and the additional finger safety for 400 V-TN systems (+ 3.0 mm) in compliance with the application directive IEC 61800-5-1.

General ordering data

Type	SV-SMT 7.62HP/05/90F 2....	Version
Order No.	2499590000	PCB plug-in connector, male header, Flange, THT/THR solder connection, 7.62 mm, Number of poles: 5, 90°, Solder pin length (l):
GTIN (EAN)	4050118513004	2.6 mm, tinned, black, Box
Qty.	50 ST	
Type	SV-SMT 7.62HP/05/90F 3....	Version
Order No.	2498450000	PCB plug-in connector, male header, Flange, THT/THR solder connection, 7.62 mm, Number of poles: 5, 90°, Solder pin length (l):
GTIN (EAN)	4050118511673	3.5 mm, tinned, black, Box
Qty.	50 ST	

SVF 7.62HP/180F

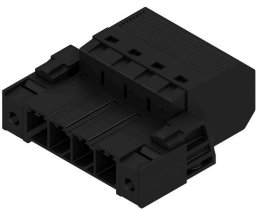

180° inverted pin header with PUSH IN connection technology for field wiring in 6mm² in a 7.62 pitch, as a “three-flange variant” for enclosure feed-through. Suitable for enclosures with a max. wall thickness of 2mm. Also perfect as a touch-safe solution for reverse voltages. Meets the requirements of UL1059 600 V Class C and IEC 61800-5-1.

General ordering data

Type	SVF 7.62HP/05/180F SN B..	Version
Order No.	1060930000	PCB plug-in connector, male plug, 7.62 mm, Number of poles:
GTIN (EAN)	4032248810796	5, 180°, PUSH IN without actuator, Tension-clamp connection,
Qty.	25 ST	Clamping range, max. : 10 mm ² , Box

BVZ 7.62HP/05/180F SN BK BX

Weidmüller Interface GmbH & Co. KG
 Klingenbergstraße 26
 D-32758 Detmold
 Germany

Counterpart

www.weidmueller.com

SVZ 7.62HP 180F SN

High-performance male header with the proven, 100% maintenance-free Weidmüller steel clamping yoke. Side-by-side mounting without sacrificing any poles or with patented multifunction flange for secure, fast fixing without tools. Maximum connection and operating reliability thanks to a mating profile that prevents incorrect connection, unique coding diversity, incorrect wiring protection. Suitable for labelling.

General ordering data

Type	SVZ 7.62HP/05/180F SN B...	Version
Order No.	1931840000	PCB plug-in connector, male plug, 7.62 mm, Number of poles: 5,
GTIN (EAN)	4032248581771	180°, Clamping yoke connection, Clamping range, max. : 6 mm ² , Box
Qty.	50 ST	