

## BCZ 3.81/07/90 SN BK BX

Weidmüller Interface GmbH & Co. KG

Klingenbergstraße 26

D-32758 Detmold

Germany

www.weidmueller.com

### Product image

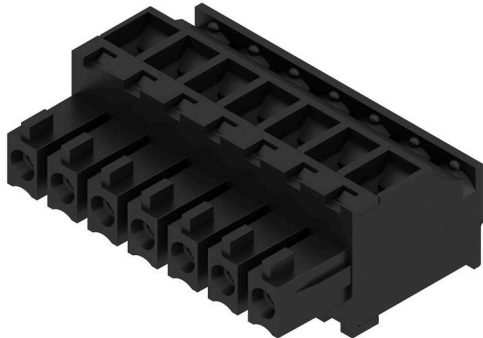

Female socket connectors with clamping-yoke screw system for connecting wires.

Three wire-outlet directions are available and provide flexible connection-level design options:

- 180° wire parallel to plugging direction
- 90° wire perpendicular and above plugging direction
- 270° wire perpendicular and below plugging direction

There are three housing shapes, covering many different requirements, to choose from:

- Standard housing without flange
- Flange with screw (F)
- Flange featuring Weidmüller's patented release latch (LR) for lock-and-release latching with no strain and no tools needed.

Weidmüller's 3.81-mm-pitch (0.15 inch) plug-in connectors are compatible with the layouts of customary connectors and offer space for labelling and coding.

### General ordering data

Version	PCB plug-in connector, female plug, 3.81 mm, Number of poles: 7, 90°, Clamping yoke connection, Clamping range, max. : 1.5 mm², Box
Order No.	<a href="#">1858960000</a>
Type	BCZ 3.81/07/90 SN BK BX
GTIN (EAN)	4032248410576
Qty.	50 items
Product data	IEC: 320 V / 17.5 A / 0.2 - 1.5 mm² UL: 300 V / 10 A / AWG 28 - AWG 16
Packaging	Box

Technical data

Approvals

Approvals



ROHS	Conform
UL File Number Search	<a href="#">UL Website</a>
Certificate No. (cURus)	E60693

Dimensions and weights

Depth	19.1 mm	Depth (inches)	0.752 inch
Height	10.5 mm	Height (inches)	0.4134 inch
Width	26.67 mm	Width (inches)	1.05 inch
Net weight	6.46 g		

Environmental Product Compliance

RoHS Compliance Status	Compliant with exemption
RoHS Exemption (if applicable/known)	6c
REACH SVHC	Lead 7439-92-1
SCIP	ea9dd4b8-c51f-409c-885a-41700372be61

System Parameters

Product family	OMNIMATE Signal - series BC/SC 3.81		
Type of connection	Field connection		
Wire connection method	Clamping yoke connection		
Pitch in mm (P)	3.81 mm		
Pitch in inches (P)	0.150 "		
Conductor outlet direction	90°		
Number of poles	7		
L1 in mm	22.86 mm		
L1 in inches	0.900 "		
Number of rows	1		
Pin series quantity	1		
Rated cross-section	1 mm <sup>2</sup>		
Touch-safe protection acc. to DIN VDE 57 106	Safe from finger touch		
Touch-safe protection acc. to DIN VDE 0470	IP20 plugged/ IP10 unplugged		
Protection degree	IP20		
Volume resistance	≤5 mΩ		
Can be coded	Yes		
Stripping length	7 mm		
Clamping screw	M 2		
Screwdriver blade	0.4 x 2.5		
Screwdriver blade standard	DIN 5264		
Plugging cycles	25		
Plugging force/pole, max.	7 N		
Pulling force/pole, max.	5 N		
Tightening torque	Torque type	Wire connection	
	Usage information	Tightening torque	min. 0.2 Nm max. 0.25 Nm

**BCZ 3.81/07/90 SN BK BX**

**Weidmüller Interface GmbH & Co. KG**  
 Klingenbergstraße 26  
 D-32758 Detmold  
 Germany

www.weidmueller.com

**Technical data**

**Material data**

Insulating material	PA 66 GF 30	Colour	black
Colour chart (similar)	RAL 9011	Insulating material group	II
Comparative Tracking Index (CTI)	≥ 550	Moisture Level (MSL)	
UL 94 flammability rating	V-0	Contact material	Cu-alloy
Contact surface	tinned	Layer structure of plug contact	0.5...1.5 µm Cu / 2...5 µm Sn
Storage temperature, min.	-40 °C	Storage temperature, max.	70 °C
Operating temperature, min.	-50 °C	Operating temperature, max.	120 °C
Temperature range, installation, min.	-25 °C	Temperature range, installation, max.	120 °C

**Conductors suitable for connection**

Clamping range, min.	0.08 mm <sup>2</sup>
Clamping range, max.	1.5 mm <sup>2</sup>
Wire connection cross section AWG, min.	AWG 28
Wire connection cross section AWG, max.	AWG 16
Solid, min. H05(07) V-U	0.2 mm <sup>2</sup>
Solid, max. H05(07) V-U	1.5 mm <sup>2</sup>
Flexible, min. H05(07) V-K	0.2 mm <sup>2</sup>
Flexible, max. H05(07) V-K	1.5 mm <sup>2</sup>
w. plastic collar ferrule, DIN 46228 pt 4, min.	0.2 mm <sup>2</sup>
w. plastic collar ferrule, DIN 46228 pt 4, max.	1.5 mm <sup>2</sup>
w. wire end ferrule, DIN 46228 pt 1, min.	0.2 mm <sup>2</sup>
w. wire end ferrule, DIN 46228 pt 1, max.	1.5 mm <sup>2</sup>
Plug gauge in accordance with EN 60999 a x b; ø	2.4 mm x 1.5 mm

Clampable conductor	Cross-section for conductor connection	Type	fine-wired	
		nominal	0.5 mm <sup>2</sup>	
	wire end ferrule	Stripping length	nominal	6 mm
		Recommended wire-end ferrule	<a href="#">H0,5/6</a>	
		Cross-section for conductor connection	Type	fine-wired
	nominal	0.75 mm <sup>2</sup>		
		wire end ferrule	Stripping length	nominal
	Recommended wire-end ferrule		<a href="#">H0,75/6</a>	
	Cross-section for conductor connection		Type	fine-wired
		nominal	1 mm <sup>2</sup>	
	wire end ferrule	Stripping length	nominal	6 mm
		Recommended wire-end ferrule	<a href="#">H1,0/6</a>	
		Cross-section for conductor connection	Type	fine-wired
	nominal		1.5 mm <sup>2</sup>	
	wire end ferrule	Stripping length	nominal	7 mm
		Recommended wire-end ferrule	<a href="#">H1,5/7</a>	

Reference text The outside diameter of the plastic collar should not be larger than the pitch (P). Length of ferrules is to be chosen depending on the product and the rated voltage.

**BCZ 3.81/07/90 SN BK BX**

**Weidmüller Interface GmbH & Co. KG**  
 Klingenbergstraße 26  
 D-32758 Detmold  
 Germany

www.weidmueller.com

**Technical data**

**Rated data acc. to IEC**

tested acc. to standard	IEC 60664-1, IEC 61984	Rated current, min. number of poles (Tu=20°C)	17.5 A
Rated current, max. number of poles (Tu=20°C)	15.9 A	Rated current, min. number of poles (Tu=40°C)	17.5 A
Rated current, max. number of poles (Tu=40°C)	14.1 A	Rated voltage for surge voltage class / pollution degree II/2	320 V
Rated voltage for surge voltage class / pollution degree III/2	160 V	Rated voltage for surge voltage class / pollution degree III/3	160 V
Rated impulse voltage for surge voltage class/ pollution degree II/2	2.5 kV	Rated impulse voltage for surge voltage class/ pollution degree III/2	2.5 kV
Rated impulse voltage for surge voltage class/ contamination degree III/3	2.5 kV	Short-time withstand current resistance	3 x 1s with 76 A

**Rated data acc. to CSA**

Institute (CSA)	CSA	Certificate No. (CSA)	200039-1121690
Rated voltage (Use group B / CSA)	300 V	Rated voltage (Use group C / CSA)	50 V
Rated current (Use group B / CSA)	8 A	Rated current (Use group C / CSA)	8 A
Wire cross-section, AWG, min.	AWG 28	Wire cross-section, AWG, max.	AWG 16
Reference to approval values	Specifications are maximum values, details - see approval certificate.		

**Rated data acc. to UL 1059**

Institute (cURus)	CURUS	Certificate No. (cURus)	E60693
Rated voltage (Use group B / UL 1059)	300 V	Rated voltage (Use group D / UL 1059)	300 V
Rated current (Use group B / UL 1059)	10 A	Rated current (Use group D / UL 1059)	10 A
Wire cross-section, AWG, min.	AWG 28	Wire cross-section, AWG, max.	AWG 16
Reference to approval values	Specifications are maximum values, details - see approval certificate.		

**Packing**

Packaging	Box	VPE length	70.00 mm
VPE width	80.00 mm	VPE height	90.00 mm

**Type tests**

Test: Durability of markings	Standard	DIN EN 61984 section 7.3.2 / 09.02 taking pattern from DIN EN 60068-2-70 / 07.96
	Test	mark of origin, type identification, rated voltage, rated cross-section, pitch, type of material, approval marking UL, approval marking CSA
	Evaluation	available
	Test	durability
Test: Misengagement (Non-interchangeability)	Standard	DIN EN 61984 section 6.3 and 6.9.1 / 09.02, DIN EN 60512-13-5 / 11.06
	Test	180° turned without coding elements
	Evaluation	passed
	Test	visual examination
Test: Clampable cross section	Standard	DIN EN 60999-1 section 7 and 9.1 / 12.00, DIN EN 60947-1 section 8.2.4.5.1 / 12.02

Technical data

	Conductor type	Type of conductor and conductor cross-section	solid 0.08 mm <sup>2</sup>
		Type of conductor and conductor cross-section	stranded 0.08 mm <sup>2</sup>
		Type of conductor and conductor cross-section	solid 1.5 mm <sup>2</sup>
		Type of conductor and conductor cross-section	stranded 1.5 mm <sup>2</sup>
		Type of conductor and conductor cross-section	AWG 28/1
		Type of conductor and conductor cross-section	AWG 28/19
		Type of conductor and conductor cross-section	AWG 16/1
		Type of conductor and conductor cross-section	AWG 16/19
Test for damage to and accidental loosening of conductors	Evaluation	passed	
	Standard	DIN EN 60999-1 section 9.4 / 12.00	
	Requirement	0.2 kg	
	Conductor type	Type of conductor and conductor cross-section	stranded 0.25 mm <sup>2</sup>
		Type of conductor and conductor cross-section	AWG 28/1
		Type of conductor and conductor cross-section	AWG 28/19
	Evaluation	passed	
	Requirement	0.3 kg	
	Conductor type	Type of conductor and conductor cross-section	solid 0.5 mm <sup>2</sup>
	Evaluation	passed	
Pull-out test	Requirement	0.4 kg	
	Conductor type	Type of conductor and conductor cross-section	solid 1.5 mm <sup>2</sup>
		Type of conductor and conductor cross-section	stranded 1.5 mm <sup>2</sup>
		Type of conductor and conductor cross-section	AWG 16/1
		Type of conductor and conductor cross-section	AWG 16/19
	Evaluation	passed	
	Standard	DIN EN 60999-1 section 9.5 / 12.00	
	Requirement	≥10 N	
	Conductor type	Type of conductor and conductor cross-section	stranded 0.25 mm <sup>2</sup>
		Type of conductor and conductor cross-section	AWG 28/1

**BCZ 3.81/07/90 SN BK BX**

**Weidmüller Interface GmbH & Co. KG**  
 Klingenbergstraße 26  
 D-32758 Detmold  
 Germany

www.weidmueller.com

**Technical data**

	Type of conductor and conductor cross-section	AWG 28/19
Evaluation	passed	
Requirement	≥20 N	
Conductor type	Type of conductor and conductor cross-section	H05V-U0.5
Evaluation	passed	
Requirement	≥40 N	
Conductor type	Type of conductor and conductor cross-section	H07V-U1.5
	Type of conductor and conductor cross-section	H07V-K1.5
	Type of conductor and conductor cross-section	AWG 16/1
	Type of conductor and conductor cross-section	AWG 16/19
Evaluation	passed	

**Important note**

**IPC conformity** Conformity: The products are developed, manufactured and delivered according international recognized standards and norms and comply with the assured properties in the data sheet resp. fulfill decorative properties in accordance with IPC-A-610 "Class 2". Further claims on the products can be evaluated on request.

- Notes**
- Additional variants on request
  - Rated current related to rated cross-section & min. No. of poles.
  - Wire end ferrule without plastic collar to DIN 46228/1
  - Wire end ferrule with plastic collar to DIN 46228/4
  - P on drawing = pitch
  - Rated data refer only to the component itself. Clearance and creepage distances to other components are to be designed in accordance with the relevant application standards.
  - In accordance with IEC 61984, OMNIMATE-connectors are connectors without breaking capacity (COC). During designated use, connectors are not allowed to be engaged or disengaged when live or under load
  - Long term storage of the product with average temperature of 50 °C and maximum humidity 70%, 36 months

**Classifications**

ETIM 8.0	EC002638	ETIM 9.0	EC002638
ETIM 10.0	EC002638	ECLASS 14.0	27-46-02-02
ECLASS 15.0	27-46-02-02		

BCZ 3.81/07/90 SN BK BX

Weidmüller Interface GmbH & Co. KG  
 Klingenbergstraße 26  
 D-32758 Detmold  
 Germany

Drawings

www.weidmueller.com

Product image

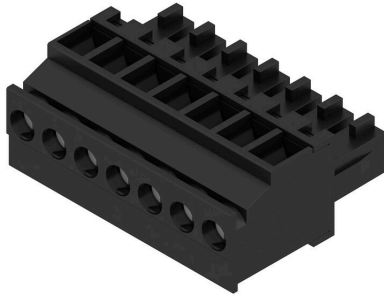

Dimensional drawing



Graph

BCZ 3.81/./90 & /270 - SC 3.81/./135



Graph

BCZ 3.81/./90 & /270 - SC-SMT 3.81/./135



Graph

BCZ 3.81/./90 & /270 - SC-SMT 3.81/./135



Graph

BCZ 3.81/./90 & /270 - SC 3.81/./135



## BCZ 3.81/07/90 SN BK BX

**Weidmüller Interface GmbH & Co. KG**  
 Klingenbergstraße 26  
 D-32758 Detmold  
 Germany

www.weidmueller.com

## Counterpart

## SC 3.81/90F



The SC pin header has a parallel (recumbent) plugging direction in relation to the PCB. It is available in closed (G) and screw flange (F) versions.

Weidmüller's 3.81-mm-pitch (0.15 inch) plug-in connectors are compatible with the layouts of standard connectors. They support a flood-light display and offer space for labelling and coding.

## General ordering data

Type	SC 3.81/07/90F 3.2SN OR...	Version
Order No.	<a href="#">1942500000</a>	PCB plug-in connector, male header, Flange, THT solder connection,
GTIN (EAN)	4032248655090	3.81 mm, Number of poles: 7, 90°, Solder pin length (l): 3.2 mm,
Qty.	48 ST	tinned, orange, Box

## SC-SMT 3.81/180LF Box



High-temperature-resistant pin header (SC-SMT 180LF) in 3.81-mm pitch (0.15 inch)

- Plugging direction is perpendicular to PCB (standing)
  - With solder flange (LF).
  - Packed either in box (BX) or on anti-static roll (tape-on-reel, RL)
  - Pin length of either 1.5 mm or 3.2 mm
- Weidmüller's 3.81-mm-pitch (0.15 inch) plug-in connectors are compatible with the layouts of standard connectors and offer space for labelling.

## General ordering data

Type	SC-SMT 3.81/07/180LF 3...	Version
Order No.	<a href="#">1863310000</a>	PCB plug-in connector, male header, Solder flange, THT/THR solder
GTIN (EAN)	4032248428489	connection, 3.81 mm, Number of poles: 7, 180°, Solder pin length (l):
Qty.	50 ST	3.2 mm, tinned, black, Box

## SC-SMT 3.81/180LF Tape



High-temperature-resistant pin header (SC-SMT 180LF) in 3.81-mm pitch (0.15 inch)

- Plugging direction is perpendicular to PCB (standing)
  - With solder flange (LF).
  - Packed either in box (BX) or on anti-static roll (tape-on-reel, RL)
  - Pin length of either 1.5 mm or 3.2 mm
- Weidmüller's 3.81-mm-pitch (0.15 inch) plug-in connectors are compatible with the layouts of standard connectors and offer space for labelling.

## General ordering data

Type	SC-SMT 3.81/07/180LF 1...	Version
Order No.	<a href="#">1864270000</a>	PCB plug-in connector, male header, Solder flange, THT/THR solder
GTIN (EAN)	4032248429578	connection, 3.81 mm, Number of poles: 7, 180°, Solder pin length (l):
Qty.	300 ST	1.5 mm, tinned, black, Tape

## BCZ 3.81/07/90 SN BK BX

Weidmüller Interface GmbH &amp; Co. KG

Klingenbergstraße 26

D-32758 Detmold

Germany

www.weidmueller.com

## Counterpart

## SC-SMT 3.81/90LF Tape



High-temperature-resistant pin header (SC-SMT 90LF) in 3.81-mm pitch (0.15 inch)

- Plugging direction parallel to PCB (recumbent)
  - With solder flange (LF).
  - Packed either in box (BX) or on anti-static roll (tape-on-reel, RL)
  - Pin length of either 1.5 mm or 3.2 mm
- Weidmüller's 3.81-mm-pitch (0.15 inch) plug-in connectors are compatible with the layouts of standard connectors and offer space for labelling.

## General ordering data

Type	SC-SMT 3.81/07/90LF 1.5...	Version
Order No.	<a href="#">1862830000</a>	PCB plug-in connector, male header, Solder flange, THT/THR solder
GTIN (EAN)	4032248427994	connection, 3.81 mm, Number of poles: 7, 90°, Solder pin length (l):
Qty.	400 ST	1.5 mm, tinned, black, Tape

## SC-SMT 3.81/90LF Box

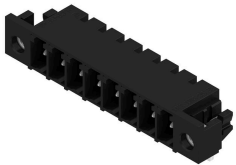

High-temperature-resistant pin header (SC-SMT 90LF) in 3.81-mm pitch (0.15 inch)

- Plugging direction parallel to PCB (recumbent)
  - With solder flange (LF).
  - Packed either in box (BX) or on anti-static roll (tape-on-reel, RL)
  - Pin length of either 1.5 mm or 3.2 mm
- Weidmüller's 3.81-mm-pitch (0.15 inch) plug-in connectors are compatible with the layouts of standard connectors and offer space for labelling.

## General ordering data

Type	SC-SMT 3.81/07/90LF 3.2...	Version
Order No.	<a href="#">1863740000</a>	PCB plug-in connector, male header, Solder flange, THT/THR solder
GTIN (EAN)	4032248428908	connection, 3.81 mm, Number of poles: 7, 90°, Solder pin length (l):
Qty.	50 ST	3.2 mm, tinned, black, Box

## SC 3.81/180F

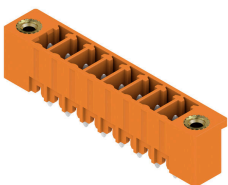

The SC pin header has a perpendicular (standing) plugging direction in relation to the PCB. It is available in closed (G) and screw flange (F) versions.

Weidmüller's 3.81-mm-pitch (0.15 inch) plug-in connectors are compatible with the layouts of standard connectors and offer space for labelling and coding.

## General ordering data

Type	SC 3.81/07/180F 3.2SN B...	Version
Order No.	<a href="#">1837010000</a>	PCB plug-in connector, male header, Flange, THT solder connection,
GTIN (EAN)	4032248345373	3.81 mm, Number of poles: 7, 180°, Solder pin length (l): 3.2 mm,
Qty.	48 ST	tinned, black, Box

## BCZ 3.81/07/90 SN BK BX

**Weidmüller Interface GmbH & Co. KG**  
 Klingenbergstraße 26  
 D-32758 Detmold  
 Germany

www.weidmueller.com

## Counterpart

Type	SC 3.81/07/180F 3.2SN O...	Version
Order No.	<a href="#">1943230000</a>	PCB plug-in connector, male header, Flange, THT solder connection,
GTIN (EAN)	4032248654369	3.81 mm, Number of poles: 7, 180°, Solder pin length (l): 3.2 mm,
Qty.	48 ST	tinned, orange, Box

## SC 3.81/90F

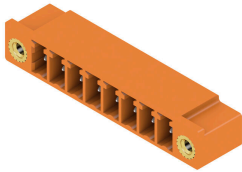

The SC pin header has a parallel (recumbent) plugging direction in relation to the PCB. It is available in closed (G) and screw flange (F) versions.

Weidmüller's 3.81-mm-pitch (0.15 inch) plug-in connectors are compatible with the layouts of standard connectors. They support a flood-light display and offer space for labelling and coding.

### General ordering data

Type	SC 3.81/07/90F 3.2SN GN...	Version
Order No.	<a href="#">1942640000</a>	PCB plug-in connector, male header, Flange, THT solder connection,
GTIN (EAN)	4032248654956	3.81 mm, Number of poles: 7, 90°, Solder pin length (l): 3.2 mm,
Qty.	50 ST	tinned, Pale green, Box
Type	SC 3.81/07/90F 3.2SN BK...	Version
Order No.	<a href="#">1942740000</a>	PCB plug-in connector, male header, Flange, THT solder connection,
GTIN (EAN)	4032248654857	3.81 mm, Number of poles: 7, 90°, Solder pin length (l): 3.2 mm,
Qty.	48 ST	tinned, black, Box

## SC 3.81/180F

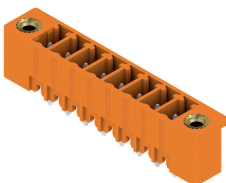

The SC pin header has a perpendicular (standing) plugging direction in relation to the PCB. It is available in closed (G) and screw flange (F) versions.

Weidmüller's 3.81-mm-pitch (0.15 inch) plug-in connectors are compatible with the layouts of standard connectors and offer space for labelling and coding.

### General ordering data

Type	SC 3.81/07/180F 3.2SN G...	Version
Order No.	<a href="#">1943370000</a>	PCB plug-in connector, male header, Flange, THT solder connection,
GTIN (EAN)	4032248654222	3.81 mm, Number of poles: 7, 180°, Solder pin length (l): 3.2 mm,
Qty.	50 ST	tinned, Pale green, Box

## BCZ 3.81/07/90 SN BK BX

**Weidmüller Interface GmbH & Co. KG**  
 Klingenbergstraße 26  
 D-32758 Detmold  
 Germany

www.weidmueller.com

## Counterpart

## SC 3.81/90G



The SC pin header has a parallel (recumbent) plugging direction in relation to the PCB. It is available in closed (G) and screw flange (F) versions.

Weidmüller's 3.81-mm-pitch (0.15 inch) plug-in connectors are compatible with the layouts of standard connectors. They support a flood-light display and offer space for labelling and coding.

## General ordering data

Type	SC 3.81/02/90G 3.2SN OR...	Version
Order No.	<a href="#">1942020000</a>	PCB plug-in connector, male header, closed side, THT solder
GTIN (EAN)	4032248655526	connection, 3.81 mm, Number of poles: 2, 90°, Solder pin length (l):
Qty.	198 ST	3.2 mm, tinned, orange, Box

## SC-SMT 3.81/180G Tape



High-temperature-resistant pin header (SC-SMT 180G) in 3.81-mm pitch (0.15 inch)

- Plugging direction is perpendicular to PCB (standing)
- Closed (G) .
- Packed either in box (BX) or on anti-static roll (tape-on-reel, RL)

• Pin length of either 1.5 mm or 3.2 mm  
 Weidmüller's 3.81-mm-pitch (0.15 inch) plug-in connectors are compatible with the layouts of standard connectors and offer space for labelling and coding.

## General ordering data

Type	SC-SMT 3.81/02/180G 1.5...	Version
Order No.	<a href="#">1864050000</a>	PCB plug-in connector, male header, closed side, THT/THR solder
GTIN (EAN)	4032248429172	connection, 3.81 mm, Number of poles: 2, 180°, Solder pin length (l):
Qty.	300 ST	1.5 mm, tinned, black, Tape

## SC-SMT 3.81/180G Box



High-temperature-resistant pin header (SC-SMT 180G) in 3.81-mm pitch (0.15 inch)

- Plugging direction is perpendicular to PCB (standing)
- Closed (G) .
- Packed either in box (BX) or on anti-static roll (tape-on-reel, RL)

• Pin length of either 1.5 mm or 3.2 mm  
 Weidmüller's 3.81-mm-pitch (0.15 inch) plug-in connectors are compatible with the layouts of standard connectors and offer space for labelling and coding.

## General ordering data

Type	SC-SMT 3.81/02/180G 1.5...	Version
Order No.	<a href="#">1863720000</a>	PCB plug-in connector, male header, closed side, THT/THR solder
GTIN (EAN)	4032248428793	connection, 3.81 mm, Number of poles: 2, 180°, Solder pin length (l):
Qty.	50 ST	1.5 mm, tinned, black, Box

## BCZ 3.81/07/90 SN BK BX

Weidmüller Interface GmbH &amp; Co. KG

Klingenbergstraße 26

D-32758 Detmold

Germany

www.weidmueller.com

## Counterpart

## SC-SMT 3.81/90G Box

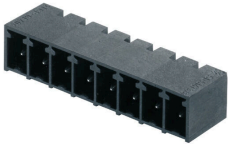

High-temperature-resistant pin header (SC-SMT 90G) in 3.81-mm pitch (0.15 inch)

- Plugging direction parallel to PCB (recumbent)
- Closed (G)
- Packed either in box (BX) or on anti-static roll (tape-on-reel, RL)

Pin length of either 1.5 mm or 3.2 mm  
Weidmüller's 3.81-mm-pitch (0.15 inch) plug-in connectors are compatible with the layouts of standard connectors and offer space for labelling and coding.

## General ordering data

Type	SC-SMT 3.81/02/90G 3.2S...	Version
Order No.	<a href="#">1862460000</a>	PCB plug-in connector, male header, closed side, THT/THR solder
GTIN (EAN)	4032248427611	connection, 3.81 mm, Number of poles: 2, 90°, Solder pin length (l):
Qty.	50 ST	3.2 mm, tinned, black, Box

## SC-SMT 3.81/180G Box



High-temperature-resistant pin header (SC-SMT 180G) in 3.81-mm pitch (0.15 inch)

- Plugging direction is perpendicular to PCB (standing)
- Closed (G)
- Packed either in box (BX) or on anti-static roll (tape-on-reel, RL)

Pin length of either 1.5 mm or 3.2 mm  
Weidmüller's 3.81-mm-pitch (0.15 inch) plug-in connectors are compatible with the layouts of standard connectors and offer space for labelling and coding.

## General ordering data

Type	SC-SMT 3.81/02/180G 3.2...	Version
Order No.	<a href="#">1862920000</a>	PCB plug-in connector, male header, closed side, THT/THR solder
GTIN (EAN)	4032248428113	connection, 3.81 mm, Number of poles: 2, 180°, Solder pin length (l):
Qty.	50 ST	3.2 mm, tinned, black, Box

## SC-SMT 3.81/90G Box



High-temperature-resistant pin header (SC-SMT 90G) in 3.81-mm pitch (0.15 inch)

- Plugging direction parallel to PCB (recumbent)
- Closed (G)
- Packed either in box (BX) or on anti-static roll (tape-on-reel, RL)

Pin length of either 1.5 mm or 3.2 mm  
Weidmüller's 3.81-mm-pitch (0.15 inch) plug-in connectors are compatible with the layouts of standard connectors and offer space for labelling and coding.

## General ordering data

Type	SC-SMT 3.81/02/90G 1.5S...	Version
Order No.	<a href="#">1862960000</a>	PCB plug-in connector, male header, closed side, THT/THR solder
GTIN (EAN)	4032248428069	connection, 3.81 mm, Number of poles: 2, 90°, Solder pin length (l):
Qty.	50 ST	1.5 mm, tinned, black, Box

## BCZ 3.81/07/90 SN BK BX

**Weidmüller Interface GmbH & Co. KG**  
 Klingenbergstraße 26  
 D-32758 Detmold  
 Germany

## Counterpart

www.weidmueller.com

## SC 3.81/180G



The SC pin header has a perpendicular (standing) plugging direction in relation to the PCB. It is available in closed (G) and screw flange (F) versions. Weidmüller's 3.81-mm-pitch (0.15 inch) plug-in connectors are compatible with the layouts of standard connectors and offer space for labelling and coding.

## General ordering data

Type	SC 3.81/02/180G 3.2SN B...	Version
Order No.	<a href="#">1793520000</a>	PCB plug-in connector, male header, closed side, THT solder
GTIN (EAN)	4032248230433	connection, 3.81 mm, Number of poles: 2, 180°, Solder pin length (l):
Qty.	50 ST	3.2 mm, tinned, black, Box

## SC 3.81/90G



The SC pin header has a parallel (recumbent) plugging direction in relation to the PCB. It is available in closed (G) and screw flange (F) versions. Weidmüller's 3.81-mm-pitch (0.15 inch) plug-in connectors are compatible with the layouts of standard connectors. They support a flood-light display and offer space for labelling and coding.

## General ordering data

Type	SC 3.81/02/90G 3.2SN BK...	Version
Order No.	<a href="#">1793130000</a>	PCB plug-in connector, male header, closed side, THT solder
GTIN (EAN)	4032248227624	connection, 3.81 mm, Number of poles: 2, 90°, Solder pin length (l):
Qty.	198 ST	3.2 mm, tinned, black, Box

## SC 3.81/180G



The SC pin header has a perpendicular (standing) plugging direction in relation to the PCB. It is available in closed (G) and screw flange (F) versions. Weidmüller's 3.81-mm-pitch (0.15 inch) plug-in connectors are compatible with the layouts of standard connectors and offer space for labelling and coding.

## General ordering data

Type	SC 3.81/02/180G 3.2SN G...	Version
Order No.	<a href="#">1793610000</a>	PCB plug-in connector, male header, closed side, THT solder
GTIN (EAN)	4032248230730	connection, 3.81 mm, Number of poles: 2, 180°, Solder pin length (l):
Qty.	198 ST	3.2 mm, tinned, Pale green, Box

## BCZ 3.81/07/90 SN BK BX

**Weidmüller Interface GmbH & Co. KG**  
 Klingenbergstraße 26  
 D-32758 Detmold  
 Germany

[www.weidmueller.com](http://www.weidmueller.com)

## Counterpart

### SC 3.81/90G



The SC pin header has a parallel (recumbent) plugging direction in relation to the PCB. It is available in closed (G) and screw flange (F) versions.

Weidmüller's 3.81-mm-pitch (0.15 inch) plug-in connectors are compatible with the layouts of standard connectors. They support a flood-light display and offer space for labelling and coding.

#### General ordering data

Type	SC 3.81/02/90G 3.2SN GN...	Version
Order No.	<a href="#">1793240000</a>	PCB plug-in connector, male header, closed side, THT solder
GTIN (EAN)	4032248227716	connection, 3.81 mm, Number of poles: 2, 90°, Solder pin length (l):
Qty.	198 ST	3.2 mm, tinned, Pale green, Box

### SC 3.81/180G



The SC pin header has a perpendicular (standing) plugging direction in relation to the PCB. It is available in closed (G) and screw flange (F) versions.

Weidmüller's 3.81-mm-pitch (0.15 inch) plug-in connectors are compatible with the layouts of standard connectors and offer space for labelling and coding.

#### General ordering data

Type	SC 3.81/02/180G 3.2SN O...	Version
Order No.	<a href="#">1942840000</a>	PCB plug-in connector, male header, closed side, THT solder
GTIN (EAN)	4032248654758	connection, 3.81 mm, Number of poles: 2, 180°, Solder pin length (l):
Qty.	198 ST	3.2 mm, tinned, orange, Box