

## BL 3.50/17/180LH SN OR BX

**Weidmüller Interface GmbH & Co. KG**  
 Klingenbergstraße 26  
 D-32758 Detmold  
 Germany

www.weidmuller.com

### Product image

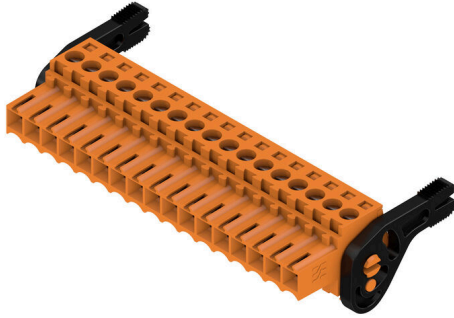

Female connectors with clamping yoke screw system for connecting conductors at 3.50 mm pitch. They provide space for labelling and can be coded.

### General ordering data

Version	PCB plug-in connector, female plug, 3.50 mm, Number of poles: 17, 180°, Clamping yoke connection, Clamping range, max. : 1.5 mm², Box
Order No.	<a href="#">1687800000</a>
Type	BL 3.50/17/180LH SN OR BX
GTIN (EAN)	4008190853358
Qty.	24 items
Product data	IEC: 320 V / 17 A / 0.2 - 1.5 mm² UL: 300 V / 10 A / AWG 28 - AWG 14
Packaging	Box
Delivery status	This article will no longer be available in the future.
Last order date	2026-10-31T00:00:00+01:00

Creation date 04.05.2026 02:49:21 MEZ

Catalogue status / Drawings

## BL 3.50/17/180LH SN OR BX

**Weidmüller Interface GmbH & Co. KG**  
 Klingenbergstraße 26  
 D-32758 Detmold  
 Germany

www.weidmueller.com

## Technical data

### Approvals

Approvals



ROHS	Conform
UL File Number Search	<a href="#">UL Website</a>
Certificate No. (UR)	E60693

### Dimensions and weights

Depth	29.5 mm	Depth (inches)	1.1614 inch
Height	14.9 mm	Height (inches)	0.5866 inch
Width	66 mm	Width (inches)	2.5984 inch
Net weight	14 g		

### Environmental Product Compliance

RoHS Compliance Status	Compliant without exemption		
REACH SVHC	No SVHC above 0.1 wt%		
Product Carbon Footprint	Cradle to gate	0,597 kg CO2 eq.	

### System Parameters

Product family	OMNIMATE Signal - series BL/SL 3.50		
Type of connection	Field connection		
Wire connection method	Clamping yoke connection		
Pitch in mm (P)	3.50 mm		
Pitch in inches (P)	0.138 "		
Conductor outlet direction	180°		
Number of poles	17		
L1 in mm	56.00 mm		
L1 in inches	2.205 "		
Number of rows	1		
Pin series quantity	1		
Rated cross-section	1.5 mm <sup>2</sup>		
Touch-safe protection acc. to DIN VDE 57 106	Safe from finger touch		
Touch-safe protection acc. to DIN VDE 0470	IP20 plugged/ IP10 unplugged		
Protection degree	IP20, when fully mounted		
Volume resistance	≤5 mΩ		
Can be coded	Yes		
Stripping length	6 mm		
Clamping screw	M 2		
Screwdriver blade	0.4 x 2.5		
Screwdriver blade standard	DIN 5264		
Plugging cycles	25		
Plugging force/pole, max.	7 N		
Pulling force/pole, max.	5 N		
Tightening torque	Torque type	Wire connection	
	Usage information	Tightening torque	min. 0.2 Nm max. 0.25 Nm

## BL 3.50/17/180LH SN OR BX

**Weidmüller Interface GmbH & Co. KG**  
 Klingenbergstraße 26  
 D-32758 Detmold  
 Germany

www.weidmueller.com

## Technical data

### Material data

Insulating material	PBT	Colour	orange
Colour chart (similar)	RAL 2000	Insulating material group	Illa
Comparative Tracking Index (CTI)	≥ 200	Moisture Level (MSL)	
UL 94 flammability rating	V-0	Contact material	Cu-alloy
Contact surface	tinned	Layer structure of plug contact	4...8 µm Sn hot-dip tinned
Storage temperature, min.	-40 °C	Storage temperature, max.	70 °C
Operating temperature, min.	-50 °C	Operating temperature, max.	100 °C
Temperature range, installation, min.	-30 °C	Temperature range, installation, max.	100 °C

### Conductors suitable for connection

Clamping range, min.	0.08 mm <sup>2</sup>
Clamping range, max.	1.5 mm <sup>2</sup>
Wire connection cross section AWG, min.	AWG 28
Wire connection cross section AWG, max.	AWG 14
Solid, min. H05(07) V-U	0.2 mm <sup>2</sup>
Solid, max. H05(07) V-U	1.5 mm <sup>2</sup>
Flexible, min. H05(07) V-K	0.2 mm <sup>2</sup>
Flexible, max. H05(07) V-K	1.5 mm <sup>2</sup>
w. plastic collar ferrule, DIN 46228 pt 4, 0.2 mm <sup>2</sup> min.	
w. plastic collar ferrule, DIN 46228 pt 4, 1.5 mm <sup>2</sup> max.	
w. wire end ferrule, DIN 46228 pt 1, min.	0.2 mm <sup>2</sup>
w. wire end ferrule, DIN 46228 pt 1, max.	1.5 mm <sup>2</sup>
Plug gauge in accordance with EN 60999 a x b; ø	2.4 mm x 1.5 mm

Clampable conductor	Cross-section for conductor connection	Type	fine-wired
		nominal	0.5 mm <sup>2</sup>
wire end ferrule	wire end ferrule	Stripping length	nominal 8 mm
		Recommended wire-end ferrule	<a href="#">H0.5/12 OR</a>
		Stripping length	nominal 6 mm
		Recommended wire-end ferrule	<a href="#">H0.5/6</a>
Cross-section for conductor connection	Cross-section for conductor connection	Type	fine-wired
		nominal	0.75 mm <sup>2</sup>
wire end ferrule	wire end ferrule	Stripping length	nominal 8 mm
		Recommended wire-end ferrule	<a href="#">H0.75/12 W</a>
		Stripping length	nominal 6 mm
		Recommended wire-end ferrule	<a href="#">H0.75/6</a>
Cross-section for conductor connection	Cross-section for conductor connection	Type	fine-wired
		nominal	1 mm <sup>2</sup>
wire end ferrule	wire end ferrule	Stripping length	nominal 8 mm
		Recommended wire-end ferrule	<a href="#">H1.0/12 GE</a>
		Stripping length	nominal 6 mm
		Recommended wire-end ferrule	<a href="#">H1.0/6</a>
Cross-section for conductor connection	Cross-section for conductor connection	Type	fine-wired
		nominal	0.25 mm <sup>2</sup>
wire end ferrule	wire end ferrule	Stripping length	nominal 8 mm

## BL 3.50/17/180LH SN OR BX

**Weidmüller Interface GmbH & Co. KG**  
 Klingenbergstraße 26  
 D-32758 Detmold  
 Germany

www.weidmueller.com

## Technical data

		Recommended wire-end ferrule	<a href="#">HO,25/10 HBL</a>
		Stripping length	nominal 5 mm
		Recommended wire-end ferrule	<a href="#">HO,25/5</a>
	Cross-section for conductor connection	Type	fine-wired
		nominal	0.34 mm <sup>2</sup>
	wire end ferrule	Stripping length	nominal 8 mm
		Recommended wire-end ferrule	<a href="#">HO,34/10 TK</a>
Reference text	The outside diameter of the plastic collar should not be larger than the pitch (P), Length of ferrules is to be chosen depending on the product and the rated voltage.		

### Rated data acc. to IEC

tested acc. to standard	IEC 60664-1, IEC 61984	Rated current, min. number of poles (Tu=20°C)	17 A
Rated current, max. number of poles (Tu=20°C)	12 A	Rated current, min. number of poles (Tu=40°C)	14.5 A
Rated current, max. number of poles (Tu=40°C)	10 A	Rated voltage for surge voltage class / pollution degree II/2	320 V
Rated voltage for surge voltage class / pollution degree III/2	160 V	Rated voltage for surge voltage class / pollution degree III/3	160 V
Rated impulse voltage for surge voltage class/ pollution degree II/2	320 V	Rated impulse voltage for surge voltage class/ pollution degree III/2	160 V
Rated impulse voltage for surge voltage class/ contamination degree III/3	160 V	Short-time withstand current resistance	3 x 1s with 100 A

### Rated data acc. to CSA

Rated voltage (Use group B / CSA)	300 V	Rated voltage (Use group D / CSA)	300 V
Rated current (Use group B / CSA)	10 A	Rated current (Use group D / CSA)	10 A
Wire cross-section, AWG, min.	AWG 28	Wire cross-section, AWG, max.	AWG 14

### Rated data acc. to UL 1059

Institute (UR)	UR	Certificate No. (UR)	E60693
Rated voltage (Use group B / UL 1059)	300 V	Rated voltage (Use group D / UL 1059)	300 V
Rated current (Use group B / UL 1059)	10 A	Rated current (Use group D / UL 1059)	10 A
Wire cross-section, AWG, min.	AWG 28	Wire cross-section, AWG, max.	AWG 14
Reference to approval values	Specifications are maximum values, details - see approval certificate.		

### Packing

Packaging	Box	VPE length	118.00 mm
VPE width	78.00 mm	VPE height	51.00 mm

### Type tests

Test: Durability of markings	Standard	DIN EN 61984 section 7.3.2 / 09.02 taking pattern from DIN EN 60068-2-70 / 07.96
	Test	mark of origin, type identification, approval marking SEV, approval marking CSA
	Evaluation	available
	Test	durability
	Evaluation	passed
Test: Misengagement (Non-interchangeability)	Standard	DIN EN 61984 section 6.3 and 6.9.1 / 09.02, DIN IEC 60512 part 7 section 5 / 05.94

**Technical data**

	Test	180° turned with coding elements	
	Evaluation	passed	
Test: Clampable cross section	Standard	DIN EN 60999-1 section 7 and 9.1 / 12.00, DIN EN 60947-1 section 8.2.4.5.1 / 12.99	
	Conductor type	Type of conductor and conductor cross-section	solid 0.2 mm <sup>2</sup>
		Type of conductor and conductor cross-section	stranded 0.2 mm <sup>2</sup>
		Type of conductor and conductor cross-section	solid 1.5 mm <sup>2</sup>
		Type of conductor and conductor cross-section	stranded 1.5 mm <sup>2</sup>
		Type of conductor and conductor cross-section	AWG 28/1
		Type of conductor and conductor cross-section	AWG 28/19
		Type of conductor and conductor cross-section	AWG 16/1
		Type of conductor and conductor cross-section	AWG 16/19
	Evaluation	passed	
Test for damage to and accidental loosening of conductors	Standard	DIN EN 60999-1 section 9.4 / 12.00	
	Requirement	0.2 kg	
	Conductor type	Type of conductor and conductor cross-section	AWG 28/1
		Type of conductor and conductor cross-section	AWG 28/19
	Evaluation	passed	
	Requirement	0.3 kg	
	Conductor type	Type of conductor and conductor cross-section	2 × AWG 24/1
		Type of conductor and conductor cross-section	2 × AWG 24/19 with wire end ferrule
	Evaluation	passed	
	Requirement	0.4 kg	
Conductor type	Type of conductor and conductor cross-section	solid 1.5 mm <sup>2</sup>	
	Type of conductor and conductor cross-section	stranded 1.5 mm <sup>2</sup>	
	Type of conductor and conductor cross-section	AWG 16/7	
Evaluation	passed		
Pull-out test	Standard	DIN EN 60999-1 section 9.5 / 12.00	
	Requirement	≥5 N	
	Conductor type	Type of conductor and conductor cross-section	AWG 28/1

**Technical data**

	Type of conductor and conductor cross-section	AWG 28/19
Evaluation	passed	
Requirement	≥10 N	
Conductor type	Type of conductor and conductor cross-section	2 × AWG 24/1
	Type of conductor and conductor cross-section	2 × AWG 24/19 with wire end ferrule
Evaluation	passed	
Requirement	≥40 N	
Conductor type	Type of conductor and conductor cross-section	H05V-U1.5
	Type of conductor and conductor cross-section	H05V-K1.5
	Type of conductor and conductor cross-section	AWG 16/7
Evaluation	passed	

**Important note**

**IPC conformity** Conformity: The products are developed, manufactured and delivered according international recognized standards and norms and comply with the assured properties in the data sheet resp. fulfill decorative properties in accordance with IPC-A-610 "Class 2". Further claims on the products can be evaluated on request.

- Notes**
- Additional variants on request
  - Gold-plated contact surfaces on request
  - Rated current related to rated cross-section & min. No. of poles.
  - Max. outer diameter of the conductor: 2.9 mm
  - Wire end ferrule without plastic collar to DIN 46228/1
  - Wire end ferrule with plastic collar to DIN 46228/4
  - P on drawing = pitch
  - Rated data refer only to the component itself. Clearance and creepage distances to other components are to be designed in accordance with the relevant application standards.
  - In accordance with IEC 61984, OMNIMATE-connectors are connectors without breaking capacity (COC). During designated use, connectors are not allowed to be engaged or disengaged when live or under load
  - Long term storage of the product with average temperature of 50 °C and maximum humidity 70%, 36 months

**Classifications**

ETIM 8.0	EC002638	ETIM 9.0	EC002638
ETIM 10.0	EC002638	ECLASS 14.0	27-46-02-02
ECLASS 15.0	27-46-02-02		

BL 3.50/17/180LH SN OR BX

Weidmüller Interface GmbH & Co. KG  
 Klingenbergstraße 26  
 D-32758 Detmold  
 Germany

www.weidmueller.com

Drawings

Product image

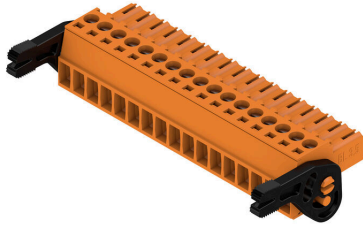

Dimensional drawing

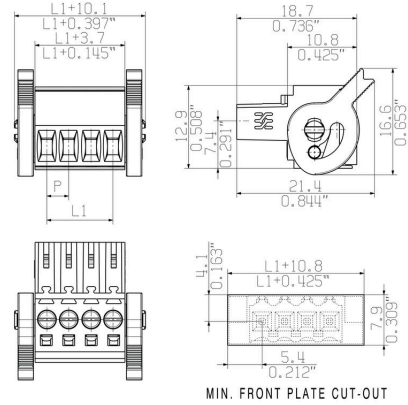

Graph

BL 3.50/.../180 - SL-SMT 3.50/.../90



Graph

BL 3.50/.../180 - SLD 3.50/.../90



Graph

BL 3.50/.../180 - SLD 3.50V/.../180



Graph

BL 3.50/.../180 - SL 3.50/.../90



## BL 3.50/17/180LH SN OR BX

**Weidmüller Interface GmbH & Co. KG**  
 Klingenbergstraße 26  
 D-32758 Detmold  
 Germany

www.weidmueller.com

## Accessories

## Strain reliefs



For frequent load changes: the "trailer coupling" for plug-in connectors.

The strain relief can do more than just relieve the strain on conductors:

Simply clip onto the plug and

- bundle conductors
- guide cables
- use as a connection and disconnection aid

No damage to the connecting points, clear, tidy wiring and easy to handle.

User advantages: permanent heavy-duty connections for harsh industrial environments and convenient operation ensure improved system availability.

## General ordering data

Type	BL 3.50 ZE03 BK BX	Version
Order No.	<a href="#">1627820000</a>	PCB plug-in connector, Accessories, Strain relief, black, Number of
GTIN (EAN)	4008190202552	poles: 3
Qty.	50 ST	
Type	BL 3.50 ZE08 BK BX	Version
Order No.	<a href="#">1627830000</a>	PCB plug-in connector, Accessories, Strain relief, black, Number of
GTIN (EAN)	4008190202576	poles: 8
Qty.	50 ST	
Type	BL 3.50 ZE03 OR BX	Version
Order No.	<a href="#">1629680000</a>	PCB plug-in connector, Accessories, Strain relief, orange, Number of
GTIN (EAN)	4008190202569	poles: 3
Qty.	50 ST	
Type	BL 3.50 ZE08 OR BX	Version
Order No.	<a href="#">1629690000</a>	PCB plug-in connector, Accessories, Strain relief, orange, Number of
GTIN (EAN)	4008190202583	poles: 8
Qty.	50 ST	

## Coding elements



Only connects what is supposed to be connected: the right connection at the right place.

Coding elements and locking devices clearly assign connecting elements during the manufacturing process and operation

The coding elements and locking devices are inserted prior to assembly or during the cable assembly phase.

The Weidmüller alternative: configure online using the variant configurator to precode prior to delivery.

Incorrect assembly on the circuit board and incorrect plugging of connecting elements is no longer possible.

The advantage: no troubleshooting during manufacture and no operational errors by the user.

## General ordering data

Type	BL SL 3.5 KO OR	Version
Order No.	<a href="#">1693430000</a>	PCB plug-in connector, Accessories, Coding element, orange, Number
GTIN (EAN)	4008190867447	of poles: 1
Qty.	100 ST	

## BL 3.50/17/180LH SN OR BX

**Weidmüller Interface GmbH & Co. KG**  
Klingenbergstraße 26  
D-32758 Detmold  
Germany

[www.weidmueller.com](http://www.weidmueller.com)

## Accessories

Type	BL SL 3.5 KO SW	Version	
Order No.	<a href="#">1610100000</a>	PCB plug-in connector, Accessories, Coding element, black, Number	
GTIN (EAN)	4008190187637	of poles: 1	
Qty.	100 ST		

## BL 3.50/17/180LH SN OR BX

**Weidmüller Interface GmbH & Co. KG**  
 Klingenbergstraße 26  
 D-32758 Detmold  
 Germany

www.weidmueller.com

## Counterpart

## SL 3.50/90



Pin headers for wave soldering in 3.50 mm pitch

- Plugging direction is parallel (90°), straight 180° or angled (135°) to the PCB
- Housing variant: screw flange (F)
- Packed in a cardboard box (BX)
- Pin header can be coded

## General ordering data

Type	SL 3.50/17/90 3.2SN OR ...	Version
Order No.	<a href="#">1618990000</a>	PCB plug-in connector, male header, open side, THT solder
GTIN (EAN)	4008190132002	connection, 3.50 mm, Number of poles: 17, 90°, Solder pin length (l):
Qty.	20 ST	3.2 mm, tinned, orange, Box

## SL 3.50/90G



Pin headers for wave soldering in 3.50 mm pitch

- Plugging direction is parallel (90°), straight 180° or angled (135°) to the PCB
- Housing variant: screw flange (F)
- Packed in a cardboard box (BX)
- Pin header can be coded

## General ordering data

Type	SL 3.50/17/90G 3.2SN OR...	Version
Order No.	<a href="#">1619380000</a>	PCB plug-in connector, male header, closed side, THT solder
GTIN (EAN)	4008190138783	connection, 3.50 mm, Number of poles: 17, 90°, Solder pin length (l):
Qty.	20 ST	3.2 mm, tinned, orange, Box

## SL 3.50/90F



Pin headers for wave soldering in 3.50 mm pitch

- Plugging direction is parallel (90°), straight 180° or angled (135°) to the PCB
- Housing variant: screw flange (F)
- Packed in a cardboard box (BX)
- Pin header can be coded

## General ordering data

Type	SL 3.50/17/90F 3.2SN OR...	Version
Order No.	<a href="#">1619770000</a>	PCB plug-in connector, male header, Flange, THT solder connection,
GTIN (EAN)	4008190146740	3.50 mm, Number of poles: 17, 90°, Solder pin length (l): 3.2 mm,
Qty.	20 ST	tinned, orange, Box

## BL 3.50/17/180LH SN OR BX

**Weidmüller Interface GmbH & Co. KG**  
 Klingenbergstraße 26  
 D-32758 Detmold  
 Germany

www.weidmueller.com

## Counterpart

Type	SL 3.50/17/90F 3.2SN DK...	Version
Order No.	<a href="#">1620210000</a>	PCB plug-in connector, male header, Flange, THT solder connection,
GTIN (EAN)	4008190153380	3.50 mm, Number of poles: 17, 90°, Solder pin length (l): 3.2 mm,
Qty.	20 ST	tinned, Signal green, Box

## SL 3.50/180

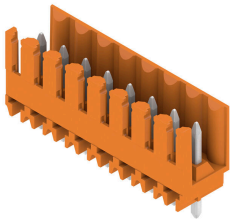

Pin headers for wave soldering in 3.50 mm pitch

- Plugging direction is parallel (90°), straight 180° or angled (135°) to the PCB
- Housing variant: screw flange (F)
- Packed in a cardboard box (BX)
- Pin header can be coded

### General ordering data

Type	SL 3.50/17/180 3.2SN OR...	Version
Order No.	<a href="#">1621400000</a>	PCB plug-in connector, male header, open side, THT solder
GTIN (EAN)	4008190171926	connection, 3.50 mm, Number of poles: 17, 180°, Solder pin length
Qty.	20 ST	(l): 3.2 mm, tinned, orange, Box

## SL 3.50/180G

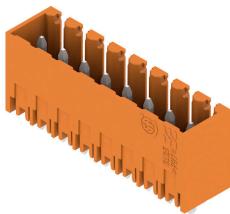

Pin headers for wave soldering in 3.50 mm pitch

- Plugging direction is parallel (90°), straight 180° or angled (135°) to the PCB
- Housing variant: screw flange (F)
- Packed in a cardboard box (BX)
- Pin header can be coded

### General ordering data

Type	SL 3.50/17/180G 3.2SN O...	Version
Order No.	<a href="#">1621790000</a>	PCB plug-in connector, male header, closed side, THT solder
GTIN (EAN)	4008190180591	connection, 3.50 mm, Number of poles: 17, 180°, Solder pin length
Qty.	20 ST	(l): 3.2 mm, tinned, orange, Box

## BL 3.50/17/180LH SN OR BX

**Weidmüller Interface GmbH & Co. KG**  
 Klingenbergstraße 26  
 D-32758 Detmold  
 Germany

## Counterpart

www.weidmueller.com

## SL 3.50/180F



- Pin headers for wave soldering in 3.50 mm pitch
- Plugging direction is parallel (90°), straight 180° or angled (135°) to the PCB
  - Housing variant: screw flange (F)
  - Packed in a cardboard box (BX)
  - Pin header can be coded

## General ordering data

Type	SL 3.50/17/180F 3.2SN O...	Version
Order No.	<a href="#">1622180000</a>	PCB plug-in connector, male header, Flange, THT solder connection,
GTIN (EAN)	4008190188641	3.50 mm, Number of poles: 17, 180°, Solder pin length (l): 3.2 mm,
Qty.	20 ST	tinned, orange, Box

## SLD 3.50/90G

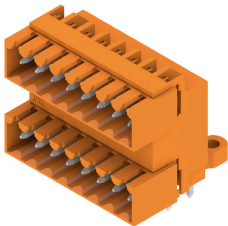

Two-tier pin header for wave soldering in 3.50 mm pitch. The connector is available in open, closed and flange versions. The male connectors provide space for labelling and can be coded. Packed in a cardboard box.

## General ordering data

Type	SLD 3.50/34/90G 3.2SN O...	Version
Order No.	<a href="#">1633730000</a>	PCB plug-in connector, male header, closed side, THT solder
GTIN (EAN)	4008190258184	connection, 3.50 mm, Number of poles: 34, 90°, Solder pin length (l):
Qty.	10 ST	3.2 mm, tinned, orange, Box

## SLD 3.50/90F

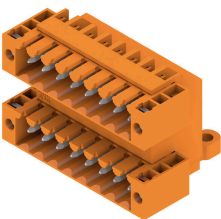

Two-tier pin header for wave soldering in 3.50 mm pitch. The connector is available in open, closed and flange versions. The male connectors provide space for labelling and can be coded. Packed in a cardboard box.

## General ordering data

Type	SLD 3.50/34/90F 3.2SN O...	Version
Order No.	<a href="#">1633960000</a>	PCB plug-in connector, male header, Flange, THT solder connection,
GTIN (EAN)	4008190258412	3.50 mm, Number of poles: 34, 90°, Solder pin length (l): 3.2 mm,
Qty.	10 ST	tinned, orange, Box

## BL 3.50/17/180LH SN OR BX

Weidmüller Interface GmbH & Co. KG  
Klingenbergstraße 26  
D-32758 Detmold  
Germany

www.weidmueller.com

## Counterpart

## SL 3.50/135F



- Pin headers for wave soldering in 3.50 mm pitch
- Plugging direction is parallel (90°), straight 180° or angled (135°) to the PCB
  - Housing variant: screw flange (F)
  - Packed in a cardboard box (BX)
  - Pin header can be coded

## General ordering data

Type	SL 3.50/17/135F 3.2SN O...	Version
Order No.	<a href="#">1643480000</a>	PCB plug-in connector, male header, Flange, THT solder connection,
GTIN (EAN)	4008190282240	3.50 mm, Number of poles: 17, 135°, Solder pin length (l): 3.2 mm,
Qty.	24 ST	tinned, orange, Box

## SL-SMT 3.5/90G Box



- High-temperature-resistant male header, 3.50 mm pitch.
- Plugging direction parallel (90°), straight 180° or angled (135°) to PCB
  - Housing variants: closed side (G), screw flange (F), solder flange (LF) or snap-on solder flange (RF)
  - Optimised for the SMT process
  - Pin length 3.2 mm universal for all soldering methods
  - Pin length 1.5 mm optimised for reflow soldering methods
  - Packed either in a box (BX) or tape-on-reel (RL)
  - Male header can be coded

## General ordering data

Type	SL-SMT 3.50/17/90G 3.2S...	Version
Order No.	<a href="#">1841780000</a>	PCB plug-in connector, male header, closed side, THT/THR solder
GTIN (EAN)	4032248353132	connection, 3.50 mm, Number of poles: 17, 90°, Solder pin length (l):
Qty.	20 ST	3.2 mm, tinned, black, Box

## SL-SMT 3.5/180G Box



- High-temperature-resistant male header, 3.50 mm pitch.
- Plugging direction parallel (90°), straight 180° or angled (135°) to PCB
  - Housing variants: closed side (G), screw flange (F), solder flange (LF) or snap-on solder flange (RF)
  - Optimised for the SMT process
  - Pin length 3.2 mm universal for all soldering methods
  - Pin length 1.5 mm optimised for reflow soldering methods
  - Packed either in a box (BX) or tape-on-reel (RL)
  - Male header can be coded

## BL 3.50/17/180LH SN OR BX

**Weidmüller Interface GmbH & Co. KG**  
 Klingenbergstraße 26  
 D-32758 Detmold  
 Germany

www.weidmueller.com

## Counterpart

## General ordering data

Type	SL-SMT 3.50/17/180G 3.2...	Version
Order No.	<a href="#">1842460000</a>	PCB plug-in connector, male header, closed side, THT/THR solder
GTIN (EAN)	4032248353811	connection, 3.50 mm, Number of poles: 17, 180°, Solder pin length
Qty.	20 ST	(!): 3.2 mm, tinned, black, Box

## SL-THR 3.5/135F



- High-temperature-resistant male header, 3.50 mm pitch.
- Plugging direction parallel (90°), straight 180° or angled (135°) to PCB
  - Housing variants: closed side (G), screw flange (F), solder flange (LF) or snap-on solder flange (RF)
  - Optimised for the SMT process
  - Pin length 3.2 mm universal for all soldering methods
  - Pin length 1.5 mm optimised for reflow soldering methods
  - Packed either in a box (BX) or tape-on-reel (RL)
  - Male header can be coded

## General ordering data

Type	SL-SMT 3.50/17/135F 3.2...	Version
Order No.	<a href="#">1003670000</a>	PCB plug-in connector, male header, Flange, THT/THR solder
GTIN (EAN)	4032248700295	connection, 3.50 mm, Number of poles: 17, 135°, Solder pin length
Qty.	24 ST	(!): 3.2 mm, tinned, black, Box

## SL-SMT 3.5/90F Box



- High-temperature-resistant male header, 3.50 mm pitch.
- Plugging direction parallel (90°), straight 180° or angled (135°) to PCB
  - Housing variants: closed side (G), screw flange (F), solder flange (LF) or snap-on solder flange (RF)
  - Optimised for the SMT process
  - Pin length 3.2 mm universal for all soldering methods
  - Pin length 1.5 mm optimised for reflow soldering methods
  - Packed either in a box (BX) or tape-on-reel (RL)
  - Male header can be coded

## General ordering data

Type	SL-SMT 3.50/17/90F 3.2S...	Version
Order No.	<a href="#">1842230000</a>	PCB plug-in connector, male header, Flange, THT/THR solder
GTIN (EAN)	4032248353583	connection, 3.50 mm, Number of poles: 17, 90°, Solder pin length (!):
Qty.	24 ST	3.2 mm, tinned, black, Box

## BL 3.50/17/180LH SN OR BX

Weidmüller Interface GmbH &amp; Co. KG

Klingenbergstraße 26

D-32758 Detmold

Germany

www.weidmueller.com

## Counterpart

## SL-SMT 3.5/180LF Box

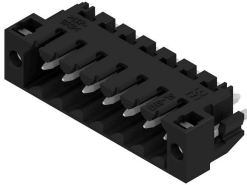

High-temperature-resistant male header, 3.50 mm pitch.

- Plugging direction parallel (90°), straight 180° or angled (135°) to PCB
- Housing variants: closed side (G), screw flange (F), solder flange (LF) or snap-on solder flange (RF)
- Optimised for the SMT process
- Pin length 3.2 mm universal for all soldering methods
- Pin length 1.5 mm optimised for reflow soldering methods
- Packed either in a box (BX) or tape-on-reel (RL)
- Male header can be coded

## General ordering data

Type	SL-SMT 3.50/17/180LF 3...	Version
Order No.	<a href="#">1842690000</a>	PCB plug-in connector, male header, Solder flange, THT/THR solder
GTIN (EAN)	4032248354054	connection, 3.50 mm, Number of poles: 17, 180°, Solder pin length
Qty.	24 ST	(l): 3.2 mm, tinned, black, Box

## SL-SMT 3.5/180F Box



High-temperature-resistant male header, 3.50 mm pitch.

- Plugging direction parallel (90°), straight 180° or angled (135°) to PCB
- Housing variants: closed side (G), screw flange (F), solder flange (LF) or snap-on solder flange (RF)
- Optimised for the SMT process
- Pin length 3.2 mm universal for all soldering methods
- Pin length 1.5 mm optimised for reflow soldering methods
- Packed either in a box (BX) or tape-on-reel (RL)
- Male header can be coded

## General ordering data

Type	SL-SMT 3.50/17/180F 3.2...	Version
Order No.	<a href="#">1842920000</a>	PCB plug-in connector, male header, Flange, THT/THR solder
GTIN (EAN)	4032248354382	connection, 3.50 mm, Number of poles: 17, 180°, Solder pin length
Qty.	24 ST	(l): 3.2 mm, tinned, black, Box

## SL-SMT 3.5/90LF Box

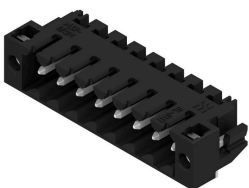

High-temperature-resistant male header, 3.50 mm pitch.

- Plugging direction parallel (90°), straight 180° or angled (135°) to PCB
- Housing variants: closed side (G), screw flange (F), solder flange (LF) or snap-on solder flange (RF)
- Optimised for the SMT process
- Pin length 3.2 mm universal for all soldering methods
- Pin length 1.5 mm optimised for reflow soldering methods
- Packed either in a box (BX) or tape-on-reel (RL)
- Male header can be coded

## BL 3.50/17/180LH SN OR BX

**Weidmüller Interface GmbH & Co. KG**  
Klingenbergstraße 26  
D-32758 Detmold  
Germany

## Counterpart

[www.weidmueller.com](http://www.weidmueller.com)

### General ordering data

Type	SL-SMT 3.50/17/90LF 3.2...	Version	
Order No.	<a href="#">1842000000</a>	PCB plug-in connector, male header, Solder flange, THT/THR solder	
GTIN (EAN)	4032248353354	connection, 3.50 mm, Number of poles: 17, 90°, Solder pin length (l):	
Qty.	24 ST	3.2 mm, tinned, black, Box	