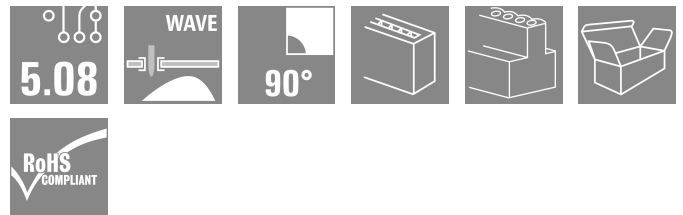
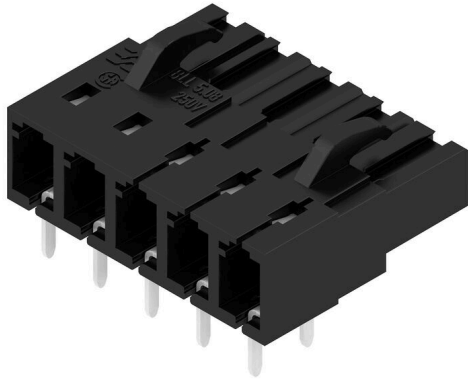

**BLL 5.08/05/90 4.5 SN BK BX**

**Weidmüller Interface GmbH & Co. KG**  
 Klingenbergstraße 26  
 D-32758 Detmold  
 Germany

www.weidmueller.com

**Product image**

Female header for PCB mounting. The solder pin length is optimised for wave flow soldering.

**General ordering data**

Version	PCB plug-in connector, female header, closed side, THT solder connection, 5.08 mm, Number of poles: 5, 90°, Solder pin length (l): 4.5 mm, tinned, black, Box
Order No.	<a href="#">1646060000</a>
Type	BLL 5.08/05/90 4.5 SN BK BX
GTIN (EAN)	4008190285401
Qty.	72 items
Product data	IEC: 400 V / 23 A UL: 300 V / 15 A
Packaging	Box

## BLL 5.08/05/90 4.5 SN BK BX

Weidmüller Interface GmbH & Co. KG  
Klingenbergstraße 26  
D-32758 Detmold  
Germany

www.weidmueller.com

## Technical data

## Approvals

Approvals



ROHS	Conform
UL File Number Search	<a href="#">UL Website</a>
Certificate No. (UR)	E60693

## Dimensions and weights

Net weight	5.25 g
------------	--------

## Environmental Product Compliance

RoHS Compliance Status	Compliant without exemption
REACH SVHC	No SVHC above 0.1 wt%

## System specifications

Product family	OMNIMATE Signal - series BL/SL 5.08	Type of connection	Board connection
Mounting onto the PCB	THT solder connection	Pitch in mm (P)	5.08 mm
Pitch in inches (P)	0.200 "	Outgoing elbow	90°
Number of poles	5	Number of solder pins per pole	2
Solder pin length (l)	4.5 mm	Solder pin length tolerance	+0.1 / -0.3 mm
Solder pin dimensions	0.4 x 1.00 mm	Solder eyelet hole diameter (D)	1.3 mm
Solder eyelet hole diameter tolerance (D)+ 0,1 mm		L1 in mm	20.32 mm
L1 in inches	0.800 "	Number of rows	1
Pin series quantity	1	Touch-safe protection acc. to DIN VDE 57 106	Safe from back-of-hand touch
Touch-safe protection acc. to DIN VDE 0470	IP20 plugged	Protection degree	IP20
Volume resistance	≤5 mΩ	Can be coded	Yes
Plugging cycles	25	Plugging force/pole, max.	5 N
Pulling force/pole, max.	5 N		

## Material data

Insulating material	PBT GF	Colour	black
Colour chart (similar)	RAL 9011	Insulating material group	IIIa
Comparative Tracking Index (CTI)	≥ 200	Insulation resistance	108 Ω
Moisture Level (MSL)		UL 94 flammability rating	V-0
Contact material	Copper alloy	Contact surface	tinned
Layer structure of solder connection	4...6 μm Sn hot-dip tinned	Layer structure of plug contact	4...6 μm Sn hot-dip tinned
Storage temperature, min.	-40 °C	Storage temperature, max.	70 °C
Operating temperature, min.	-50 °C	Operating temperature, max.	100 °C
Temperature range, installation, min.	-25 °C	Temperature range, installation, max.	100 °C

## Rated data acc. to IEC

tested acc. to standard	IEC 60664-1, IEC 61984	Rated current, min. number of poles (Tu=20°C)	23 A
Rated current, max. number of poles (Tu=20°C)	16 A	Rated current, min. number of poles (Tu=40°C)	20 A

## BLL 5.08/05/90 4.5 SN BK BX

**Weidmüller Interface GmbH & Co. KG**

Klingenbergstraße 26  
D-32758 Detmold  
Germany

www.weidmueller.com

## Technical data

Rated current, max. number of poles (Tu=40°C)	14 A	Rated voltage for surge voltage class / pollution degree II/2	400 V
Rated voltage for surge voltage class / pollution degree III/2	320 V	Rated voltage for surge voltage class / pollution degree III/3	250 V
Rated impulse voltage for surge voltage class/ pollution degree II/2	4 V	Rated impulse voltage for surge voltage class/ pollution degree III/2	4 kV
Rated impulse voltage for surge voltage class/ contamination degree III/3	4 kV	Short-time withstand current resistance	3 x 1s with 120 A

### Rated data acc. to CSA

Institute (CSA)	CSA	Certificate No. (CSA)	200039-1121690
Rated voltage (Use group B / CSA)	300 V	Rated voltage (Use group D / CSA)	300 V
Rated current (Use group B / CSA)	15 A	Rated current (Use group D / CSA)	10 A
Reference to approval values	Specifications are maximum values, details - see approval certificate.		

### Rated data acc. to UL 1059

Institute (UR)	UR	Certificate No. (UR)	E60693
Rated voltage (Use group B / UL 1059)	300 V	Rated voltage (Use group D / UL 1059)	300 V
Rated current (Use group B / UL 1059)	15 A	Rated current (Use group D / UL 1059)	10 A
Reference to approval values	Specifications are maximum values, details - see approval certificate.		

### Packing

Packaging	Box	VPE length	349.00 mm
VPE width	138.00 mm	VPE height	31.00 mm

### Important note

IPC conformity  
Conformity: The products are developed, manufactured and delivered according international recognized standards and norms and comply with the assured properties in the data sheet resp. fulfill decorative properties in accordance with IPC-A-610 "Class 2". Further claims on the products can be evaluated on request.

- Notes
- Additional variants on request
  - Gold-plated contact surfaces on request
  - Rated current related to rated cross-section & min. No. of poles.
  - P on drawing = pitch
  - Rated data refer only to the component itself. Clearance and creepage distances to other components are to be designed in accordance with the relevant application standards.
  - In accordance with IEC 61984, OMNIMATE-connectors are connectors without breaking capacity (COC). During designated use, connectors are not allowed to be engaged or disengaged when live or under load
  - Long term storage of the product with average temperature of 50 °C and maximum humidity 70%, 36 months

### Classifications

ETIM 8.0	EC002637	ETIM 9.0	EC002637
ETIM 10.0	EC002637	ECLASS 14.0	27-46-02-01
ECLASS 15.0	27-46-02-01		

Product image

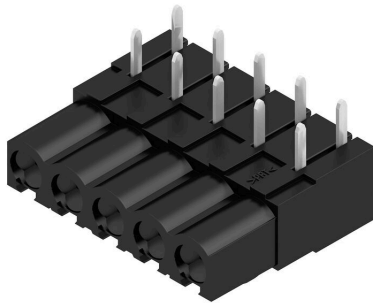

Dimensional drawing

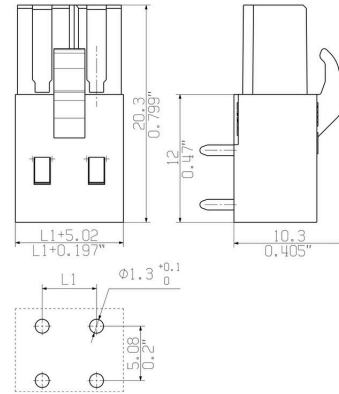

Example of use

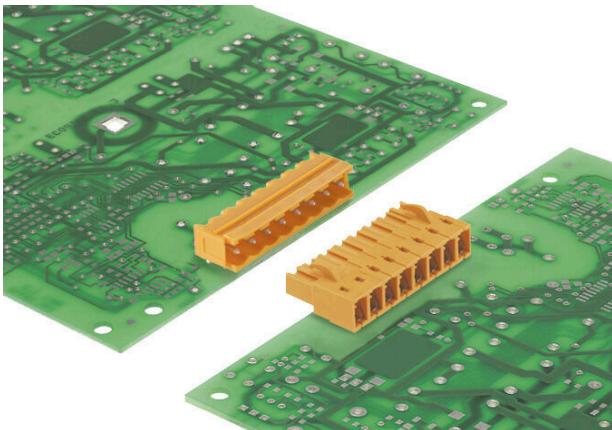

### Coding elements



Only connects what is supposed to be connected: the right connection at the right place.  
 Coding elements and locking devices clearly assign connecting elements during the manufacturing process and operation  
 The coding elements and locking devices are inserted prior to assembly or during the cable assembly phase. The Weidmüller alternative: configure online using the variant configurator to precode prior to delivery. Incorrect assembly on the circuit board and incorrect plugging of connecting elements is no longer possible. The advantage: no troubleshooting during manufacture and no operational errors by the user.

### General ordering data

Type	BLZ/SL KO BK BX	Version
Order No.	<a href="#">1545710000</a>	PCB plug-in connector, Accessories, Coding element, black, Number
GTIN (EAN)	4008190087142	of poles: 1
Qty.	50 ST	
Type	BLZ/SL KO OR BX	Version
Order No.	<a href="#">1573010000</a>	PCB plug-in connector, Accessories, Coding element, orange, Number
GTIN (EAN)	4008190048396	of poles: 1
Qty.	100 ST	

## BLL 5.08/05/90 4.5 SN BK BX

**Weidmüller Interface GmbH & Co. KG**  
 Klingenbergstraße 26  
 D-32758 Detmold  
 Germany

www.weidmueller.com

## Counterpart

### SL 5.00/90B

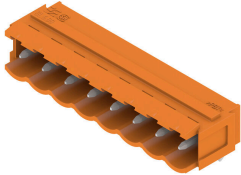

Male connectors with 90° outlet direction. The solder pin length is optimised for wave flow soldering. The pin headers provide space for labelling and can be coded.

#### General ordering data

Type	SL 5.00/05/90B 4.5SN BK...	Version	
Order No.	<a href="#">1626230000</a>	PCB plug-in connector, male header, Dovetails for fixing blocks, THT	
GTIN (EAN)	4008190197537	solder connection, 5.00 mm, Number of poles: 5, 90°, Solder pin	
Qty.	50 ST	length (l): 4.5 mm, tinned, black, Box	

### SLS 5.08/180B

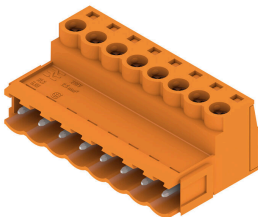

Male plugs with clamping-yoke screw wire-connect system. The male plugs provide space for labelling and can be coded.

#### General ordering data

Type	SLS 5.08/05/180B SN OR ...	Version	
Order No.	<a href="#">1627270000</a>	PCB plug-in connector, male plug, 5.08 mm, Number of poles: 5,	
GTIN (EAN)	4008190199784	180°, Clamping yoke connection, Clamping range, max. : 3.31 mm²,	
Qty.	66 ST	Box	

### SLZF 5.08/90B



Male plugs with tension-clamp wire connection. The male plugs provide space for labelling and can be coded.

#### General ordering data

Type	SLZF 5.08/05/90B SN OR ...	Version	
Order No.	<a href="#">1673580000</a>	PCB plug-in connector, male plug, 5.08 mm, Number of poles: 5, 90°,	
GTIN (EAN)	4008190435295	Tension-clamp connection, Clamping range, max. : 3.31 mm², Box	
Qty.	50 ST		

## BLL 5.08/05/90 4.5 SN BK BX

**Weidmüller Interface GmbH & Co. KG**  
 Klingenbergstraße 26  
 D-32758 Detmold  
 Germany

## Counterpart

www.weidmueller.com

### SLZF 5.08/270B



Male plugs with tension-clamp wire connection. The male plugs provide space for labelling and can be coded.

#### General ordering data

Type	SLZF 5.08/05/270B SN OR...	Version
Order No.	<a href="#">1706170000</a>	PCB plug-in connector, male plug, 5.08 mm, Number of poles: 5,
GTIN (EAN)	4032248198030	270°, Tension-clamp connection, Clamping range, max. : 3.31 mm²,
Qty.	50 ST	Box
Type	SLZF 5.08/05/270B SN BK...	Version
Order No.	<a href="#">1706400000</a>	PCB plug-in connector, male plug, 5.08 mm, Number of poles: 5,
GTIN (EAN)	4032248198047	270°, Tension-clamp connection, Clamping range, max. : 3.31 mm²,
Qty.	50 ST	Box

### SLZF 5.08/180B



Male plugs with tension-clamp wire connection. The male plugs provide space for labelling and can be coded.

#### General ordering data

Type	SLZF 5.08/05/180B SN OR...	Version
Order No.	<a href="#">1710240000</a>	PCB plug-in connector, male plug, 5.08 mm, Number of poles: 5,
GTIN (EAN)	4008190319557	180°, Tension-clamp connection, Clamping range, max. : 3.31 mm²,
Qty.	50 ST	Box

### SL 5.08/90B

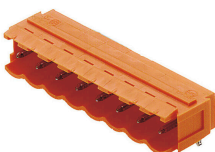

Male connectors with 90° outlet direction. The solder pin length is optimised for wave flow soldering. The pin headers provide space for labelling and can be coded.

## BLL 5.08/05/90 4.5 SN BK BX

Weidmüller Interface GmbH & Co. KG  
Klingenbergstraße 26  
D-32758 Detmold  
Germany

www.weidmueller.com

## Counterpart

## General ordering data

Type	SL 5.08/05/90B 3.2SN BK...	Version
Order No.	<a href="#">1510610000</a>	PCB plug-in connector, male header, Dovetails for fixing blocks, THT
GTIN (EAN)	4008190204051	solder connection, 5.08 mm, Number of poles: 5, 90°, Solder pin
Qty.	50 ST	length (l): 3.2 mm, tinned, black, Box
Type	SL 5.08/05/90B 3.2SN DK...	Version
Order No.	<a href="#">1510650000</a>	PCB plug-in connector, male header, Dovetails for fixing blocks, THT
GTIN (EAN)	4008190292140	solder connection, 5.08 mm, Number of poles: 5, 90°, Solder pin
Qty.	50 ST	length (l): 3.2 mm, tinned, Signal green, Box
Type	SL 5.08/05/90B 3.2SN OR...	Version
Order No.	<a href="#">1510660000</a>	PCB plug-in connector, male header, Dovetails for fixing blocks, THT
GTIN (EAN)	4008190121372	solder connection, 5.08 mm, Number of poles: 5, 90°, Solder pin
Qty.	50 ST	length (l): 3.2 mm, tinned, orange, Box
Type	SL 5.08/05/90B 4.5SN BK...	Version
Order No.	<a href="#">1515210000</a>	PCB plug-in connector, male header, Dovetails for fixing blocks, THT
GTIN (EAN)	4008190001117	solder connection, 5.08 mm, Number of poles: 5, 90°, Solder pin
Qty.	50 ST	length (l): 4.5 mm, tinned, black, Box
Type	SL 5.08/05/90B 4.5SN OR...	Version
Order No.	<a href="#">1515260000</a>	PCB plug-in connector, male header, Dovetails for fixing blocks, THT
GTIN (EAN)	4008190054359	solder connection, 5.08 mm, Number of poles: 5, 90°, Solder pin
Qty.	50 ST	length (l): 4.5 mm, tinned, orange, Box

## SL 5.08/180B



Male connectors with straight outlet direction. The solder pin length is optimised for wave flow soldering. The pin headers provide space for labelling and can be coded.

## General ordering data

Type	SL 5.08/05/180B 3.2SN D...	Version
Order No.	<a href="#">1519850000</a>	PCB plug-in connector, male header, Dovetails for fixing blocks, THT
GTIN (EAN)	4008190291341	solder connection, 5.08 mm, Number of poles: 5, 180°, Solder pin
Qty.	50 ST	length (l): 3.2 mm, tinned, Signal green, Box
Type	SL 5.08/05/180B 3.2SN O...	Version
Order No.	<a href="#">1519860000</a>	PCB plug-in connector, male header, Dovetails for fixing blocks, THT
GTIN (EAN)	4008190014094	solder connection, 5.08 mm, Number of poles: 5, 180°, Solder pin
Qty.	50 ST	length (l): 3.2 mm, tinned, orange, Box
Type	SL 5.08/05/180B 4.5SN B...	Version
Order No.	<a href="#">1524410000</a>	PCB plug-in connector, male header, Dovetails for fixing blocks, THT
GTIN (EAN)	4008190046804	solder connection, 5.08 mm, Number of poles: 5, 180°, Solder pin
Qty.	50 ST	length (l): 4.5 mm, tinned, black, Box
Type	SL 5.08/05/180B 4.5SN O...	Version
Order No.	<a href="#">1524460000</a>	PCB plug-in connector, male header, Dovetails for fixing blocks, THT
GTIN (EAN)	4008190125424	solder connection, 5.08 mm, Number of poles: 5, 180°, Solder pin
Qty.	50 ST	length (l): 4.5 mm, tinned, orange, Box



## BLL 5.08/05/90 4.5 SN BK BX

**Weidmüller Interface GmbH & Co. KG**  
 Klingenbergstraße 26  
 D-32758 Detmold  
 Germany

www.weidmueller.com

## Counterpart

### SL 5.00/90B

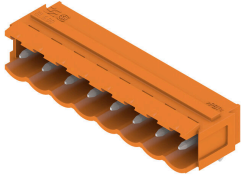

Male connectors with 90° outlet direction. The solder pin length is optimised for wave flow soldering. The pin headers provide space for labelling and can be coded.

#### General ordering data

Type	SL 5.00/05/90B 3.2SN OR...	Version
Order No.	<a href="#">1580890000</a>	PCB plug-in connector, male header, Dovetails for fixing blocks, THT
GTIN (EAN)	4008190042578	solder connection, 5.00 mm, Number of poles: 5, 90°, Solder pin
Qty.	50 ST	length (l): 3.2 mm, tinned, orange, Box

### SL 5.08/135B



Male connectors with 135° outlet direction. The solder pin length is optimised for wave flow soldering. The pin headers provide space for labelling and can be coded.

#### General ordering data

Type	SL 5.08/05/135B 3.2SN O...	Version
Order No.	<a href="#">1605560000</a>	PCB plug-in connector, male header, Dovetails for fixing blocks, THT
GTIN (EAN)	4008190089948	solder connection, 5.08 mm, Number of poles: 5, 135°, Solder pin
Qty.	50 ST	length (l): 3.2 mm, tinned, orange, Box

### SLT 5.08B

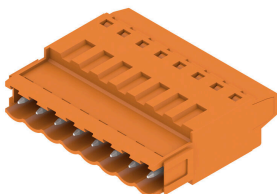

Male plugs with screw TOP wire connection. The male plug provides space for labelling and can be coded.

#### General ordering data

Type	SLT 5.08/05/180B SN OR ...	Version
Order No.	<a href="#">1611740000</a>	PCB plug-in connector, male plug, 5.08 mm, Number of poles: 5,
GTIN (EAN)	4008190192624	180°, TOP connection, Clamping range, max.: 2.5 mm², Box
Qty.	50 ST	

## BLL 5.08/05/90 4.5 SN BK BX

**Weidmüller Interface GmbH & Co. KG**  
 Klingenbergstraße 26  
 D-32758 Detmold  
 Germany

www.weidmueller.com

## Counterpart

## SLDV-THR 5.08/180F



High-temperature resistant, double level, laterally offset, male connector with flange or solder flange. 1.5 mm solder pin is suitable for reflow soldering. 3.2 mm solder pin suitable for reflow and wave soldering. The pin headers provide space for labelling and can be coded.

## General ordering data

Type	SLDV-THR 5.08/10/180F 1...	Version
Order No.	<a href="#">1828920000</a>	PCB plug-in connector, male header, Flange, THT/THR solder
GTIN (EAN)	4032248335619	connection, 5.08 mm, Number of poles: 10, 180°, Solder pin length
Qty.	32 ST	(l): 1.5 mm, tinned, black, Box

## SLDV-THR 5.08/180FLF



High-temperature resistant, double level, laterally offset, male connector with flange or solder flange. 1.5 mm solder pin is suitable for reflow soldering. 3.2 mm solder pin suitable for reflow and wave soldering. The pin headers provide space for labelling and can be coded.

## General ordering data

Type	SLDV-THR 5.08/10/180FLF...	Version
Order No.	<a href="#">1829040000</a>	PCB plug-in connector, male header, Flange / Solder flange, THT/THR
GTIN (EAN)	4032248335732	solder connection, 5.08 mm, Number of poles: 10, 180°, Solder pin
Qty.	32 ST	length (l): 3.2 mm, tinned, black, Box

## SLDV-THR 5.08/180F



High-temperature resistant, double level, laterally offset, male connector with flange or solder flange. 1.5 mm solder pin is suitable for reflow soldering. 3.2 mm solder pin suitable for reflow and wave soldering. The pin headers provide space for labelling and can be coded.

## General ordering data

Type	SLDV-THR 5.08/10/180F 3...	Version
Order No.	<a href="#">1828800000</a>	PCB plug-in connector, male header, Flange, THT/THR solder
GTIN (EAN)	4032248335480	connection, 5.08 mm, Number of poles: 10, 180°, Solder pin length
Qty.	32 ST	(l): 3.2 mm, tinned, black, Box

**BLL 5.08/05/90 4.5 SN BK BX**

**Weidmüller Interface GmbH & Co. KG**  
 Klingenbergstraße 26  
 D-32758 Detmold  
 Germany

**Counterpart**

www.weidmueller.com

**SL-SMT 5.08HC/90F Box**

High-temperature-resistant pin header, packed in box or tape. On tape, with 1.5 mm solder pin, optimised for automatic assembly. 3.2 mm solder pin suitable for reflow and wave soldering. The pin headers provide space for labelling and can be coded. HC = High Current.

**General ordering data**

Type	SL-SMT 5.08HC/05/90F 3...	Version
Order No.	<a href="#">1837660000</a>	PCB plug-in connector, male header, Flange, THT/THR solder
GTIN (EAN)	4032248347476	connection, 5.08 mm, Number of poles: 5, 90°, Solder pin length (l):
Qty.	48 ST	3.2 mm, tinned, black, Box

**SL-SMT 5.08/180F Box**

High-temperature-resistant pin header, packed in box or tape. On tape, with 1.5 mm solder pin, optimised for automatic assembly. 3.2 mm solder pin suitable for reflow and wave soldering. The pin headers provide space for labelling and can be coded. HC = High Current.

**General ordering data**

Type	SL-SMT 5.08HC/05/180F 1...	Version
Order No.	<a href="#">1837330000</a>	PCB plug-in connector, male header, Flange, THT/THR solder
GTIN (EAN)	4032248345922	connection, 5.08 mm, Number of poles: 5, 180°, Solder pin length (l):
Qty.	48 ST	1.5 mm, tinned, black, Box

**SL-SMT 5.00HC/90LF Box**

High-temperature-resistant pin header, packed in box or tape. On tape, with 1.5 mm solder pin, optimised for automatic assembly. 3.2 mm solder pin suitable for reflow and wave soldering. The pin headers provide space for labelling and can be coded. HC = High Current.

**General ordering data**

Type	SL-SMT 5.00HC/05/90LF 3...	Version
Order No.	<a href="#">1840380000</a>	PCB plug-in connector, male header, Solder flange, THT/THR solder
GTIN (EAN)	4032248351220	connection, 5.00 mm, Number of poles: 5, 90°, Solder pin length (l):
Qty.	48 ST	3.2 mm, tinned, black, Box

## BLL 5.08/05/90 4.5 SN BK BX

**Weidmüller Interface GmbH & Co. KG**  
 Klingenbergstraße 26  
 D-32758 Detmold  
 Germany

www.weidmueller.com

## Counterpart

### SL-SMT 5.08/180LF Box



High-temperature-resistant pin header, packed in box or tape. On tape, with 1.5 mm solder pin, optimised for automatic assembly. 3.2 mm solder pin suitable for reflow and wave soldering. The pin headers provide space for labelling and can be coded. HC = High Current.

#### General ordering data

Type	SL-SMT 5.08HC/05/180LF ...	Version
Order No.	<a href="#">1838470000</a>	PCB plug-in connector, male header, Solder flange, THT/THR solder connection, 5.08 mm, Number of poles: 5, 180°, Solder pin length (l):
GTIN (EAN)	4032248348534	3.2 mm, tinned, black, Box
Qty.	48 ST	

### SLZF 5.08/180F



Male plugs with tension-clamp wire connection. The male plugs provide space for labelling and can be coded.

#### General ordering data

Type	SLZF 5.08/05/180F SN OR...	Version
Order No.	<a href="#">1846970000</a>	PCB plug-in connector, male plug, 5.08 mm, Number of poles: 5,
GTIN (EAN)	4032248363131	180°, Tension-clamp connection, Clamping range, max. : 3.31 mm <sup>2</sup> ,
Qty.	50 ST	Box

### SLS 5.08/180FI

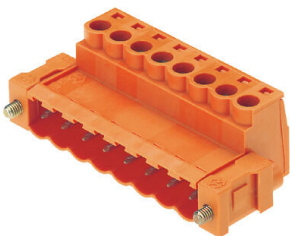

Male plugs with clamping-yoke screw wire-connect system. The male plugs provide space for labelling and can be coded.

#### General ordering data

Type	SLS 5.08/05/180FI SN OR...	Version
Order No.	<a href="#">1846240000</a>	PCB plug-in connector, male plug, 5.08 mm, Number of poles: 5,
GTIN (EAN)	4032248362523	180°, Clamping yoke connection, Clamping range, max. : 3.31 mm <sup>2</sup> ,
Qty.	48 ST	Box

## BLL 5.08/05/90 4.5 SN BK BX

Weidmüller Interface GmbH & Co. KG  
Klingenbergstraße 26  
D-32758 Detmold  
Germany

www.weidmueller.com

## Counterpart

## SLS 5.08/180F



Male plugs with clamping-yoke screw wire-connect system. The male plugs provide space for labelling and can be coded.

## General ordering data

Type	SLS 5.08/05/180F SN OR ...	Version
Order No.	<a href="#">1846390000</a>	PCB plug-in connector, male plug, 5.08 mm, Number of poles: 5,
GTIN (EAN)	4032248362097	180°, Clamping yoke connection, Clamping range, max. : 3.31 mm²,
Qty.	48 ST	Box

## SL-SMT 5.08HC/90LF Box



High-temperature-resistant pin header, packed in box or tape. On tape, with 1.5 mm solder pin, optimised for automatic assembly. 3.2 mm solder pin suitable for reflow and wave soldering. The pin headers provide space for labelling and can be coded. HC = High Current.

## General ordering data

Type	SL-SMT 5.08HC/05/90LF 1...	Version
Order No.	<a href="#">1775262001</a>	PCB plug-in connector, male header, Solder flange, THT/THR solder
GTIN (EAN)	4032248157242	connection, 5.08 mm, Number of poles: 5, 90°, Solder pin length (l):
Qty.	48 ST	1.5 mm, tinned, black, Box

## SL-SMT 5.08/180LF Tape

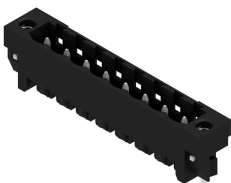

High-temperature-resistant pin header, packed in box or tape. On tape, with 1.5 mm solder pin, optimised for automatic assembly. 3.2 mm solder pin suitable for reflow and wave soldering. The pin headers provide space for labelling and can be coded. HC = High Current.

## General ordering data

Type	SL-SMT 5.08HC/05/180LF ...	Version
Order No.	<a href="#">1776394001</a>	PCB plug-in connector, male header, Solder flange, THT/THR solder
GTIN (EAN)	4032248163618	connection, 5.08 mm, Number of poles: 5, 180°, Solder pin length (l):
Qty.	250 ST	1.5 mm, tinned, black, Tape

## BLL 5.08/05/90 4.5 SN BK BX

Weidmüller Interface GmbH & Co. KG  
Klingenbergstraße 26  
D-32758 Detmold  
Germany

www.weidmueller.com

## Counterpart

## SL-SMT 5.08HC/90LF Tape



High-temperature-resistant pin header, packed in box or tape. On tape, with 1.5 mm solder pin, optimised for automatic assembly. 3.2 mm solder pin suitable for reflow and wave soldering. The pin headers provide space for labelling and can be coded. HC = High Current.

## General ordering data

Type	SL-SMT 5.08HC/05/90LF 1...	Version
Order No.	<a href="#">1775264001</a>	PCB plug-in connector, male header, Solder flange, THT/THR solder
GTIN (EAN)	4032248167814	connection, 5.08 mm, Number of poles: 5, 90°, Solder pin length (l):
Qty.	350 ST	1.5 mm, tinned, black, Tape

## SL-SMT 5.00HC/90LF Tape



High-temperature-resistant pin header, packed in box or tape. On tape, with 1.5 mm solder pin, optimised for automatic assembly. 3.2 mm solder pin suitable for reflow and wave soldering. The pin headers provide space for labelling and can be coded. HC = High Current.

## General ordering data

Type	SL-SMT 5.00HC/05/90LF 1...	Version
Order No.	<a href="#">1797780000</a>	PCB plug-in connector, male header, Solder flange, THT/THR solder
GTIN (EAN)	4032248239788	connection, 5.00 mm, Number of poles: 5, 90°, Solder pin length (l):
Qty.	350 ST	1.5 mm, tinned, black, Tape

## SL-SMT 5.08/180LF Box

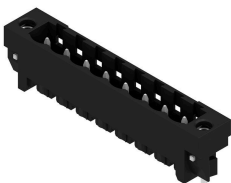

High-temperature-resistant pin header, packed in box or tape. On tape, with 1.5 mm solder pin, optimised for automatic assembly. 3.2 mm solder pin suitable for reflow and wave soldering. The pin headers provide space for labelling and can be coded. HC = High Current.

## General ordering data

Type	SL-SMT 5.08HC/05/180LF ...	Version
Order No.	<a href="#">1776392001</a>	PCB plug-in connector, male header, Solder flange, THT/THR solder
GTIN (EAN)	4032248159178	connection, 5.08 mm, Number of poles: 5, 180°, Solder pin length (l):
Qty.	48 ST	1.5 mm, tinned, black, Box

## BLL 5.08/05/90 4.5 SN BK BX

Weidmüller Interface GmbH & Co. KG  
Klingenbergstraße 26  
D-32758 Detmold  
Germany

www.weidmueller.com

## Counterpart

## SL-SMT 5.00HC/90LF Box



High-temperature-resistant pin header, packed in box or tape. On tape, with 1.5 mm solder pin, optimised for automatic assembly. 3.2 mm solder pin suitable for reflow and wave soldering. The pin headers provide space for labelling and can be coded. HC = High Current.

## General ordering data

Type	SL-SMT 5.00HC/05/90LF 1...	Version
Order No.	<a href="#">1797260000</a>	PCB plug-in connector, male header, Solder flange, THT/THR solder
GTIN (EAN)	4032248238040	connection, 5.00 mm, Number of poles: 5, 90°, Solder pin length (l):
Qty.	50 ST	1.5 mm, tinned, black, Box

## SL-SMT 5.08HC/90LF Box



High-temperature-resistant pin header, packed in box or tape. On tape, with 1.5 mm solder pin, optimised for automatic assembly. 3.2 mm solder pin suitable for reflow and wave soldering. The pin headers provide space for labelling and can be coded. HC = High Current.

## General ordering data

Type	SL-SMT 5.08HC/05/90LF 3...	Version
Order No.	<a href="#">1780440000</a>	PCB plug-in connector, male header, Solder flange, THT/THR solder
GTIN (EAN)	4032248165766	connection, 5.08 mm, Number of poles: 5, 90°, Solder pin length (l):
Qty.	48 ST	3.2 mm, tinned, black, Box

## SL-SMT 5.08/180F Box



High-temperature-resistant pin header, packed in box or tape. On tape, with 1.5 mm solder pin, optimised for automatic assembly. 3.2 mm solder pin suitable for reflow and wave soldering. The pin headers provide space for labelling and can be coded. HC = High Current.

## General ordering data

Type	SL-SMT 5.08HC/05/180F 3...	Version
Order No.	<a href="#">1820770000</a>	PCB plug-in connector, male header, Flange, THT/THR solder
GTIN (EAN)	4032248317639	connection, 5.08 mm, Number of poles: 5, 180°, Solder pin length (l):
Qty.	48 ST	3.2 mm, tinned, black, Box

## BLL 5.08/05/90 4.5 SN BK BX

**Weidmüller Interface GmbH & Co. KG**  
 Klingenbergstraße 26  
 D-32758 Detmold  
 Germany

## Counterpart

www.weidmueller.com

### SL 5.00/90



Male connectors with 90° outlet direction. The solder pin length is optimised for wave flow soldering. The pin headers provide space for labelling and can be coded.

#### General ordering data

Type	SL 5.00/05/90 4.5SN BK ...	Version
Order No.	<a href="#">1626020000</a>	PCB plug-in connector, male header, open side, THT solder
GTIN (EAN)	4008190197322	connection, 5.00 mm, Number of poles: 5, 90°, Solder pin length (l):
Qty.	50 ST	4.5 mm, tinned, black, Box

### SLS 5.08/180 SN

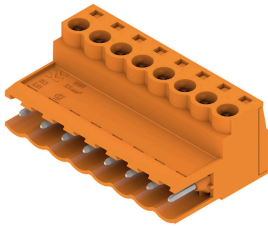

Male plugs with clamping-yoke screw wire-connect system. The male plugs provide space for labelling and can be coded.

#### General ordering data

Type	SLS 5.08/05/180 SN OR BX	Version
Order No.	<a href="#">1627120000</a>	PCB plug-in connector, male plug, 5.08 mm, Number of poles: 5,
GTIN (EAN)	4008190199630	180°, Clamping yoke connection, Clamping range, max. : 3.31 mm²,
Qty.	72 ST	Box

### SLS 5.08/180T SN

#### General ordering data

Type	SLS 5.08/05/180T SN OR ...	Version
Order No.	<a href="#">1627400000</a>	PCB plug-in connector, male plug, 5.08 mm, Number of poles: 5,
GTIN (EAN)	4008190199913	180°, Clamping yoke connection, Clamping range, max. : 3.31 mm²,
Qty.	72 ST	Box



## BLL 5.08/05/90 4.5 SN BK BX

**Weidmüller Interface GmbH & Co. KG**  
 Klingenbergstraße 26  
 D-32758 Detmold  
 Germany

www.weidmueller.com

## Counterpart

## SLDF 5.08

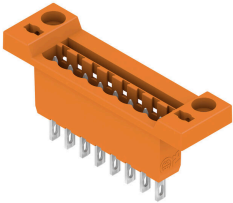

Male connector for through-panel mounting with optional locking function. Internal connection as flat-blade or solder connection. These male connectors provide space for labelling and can be coded.

## General ordering data

Type	SLDF 5.08 L/F 5 SN BK BX	Version	
Order No.	<a href="#">1635770000</a>	PCB plug-in connector, male header, 5.08 mm, Number of poles: 5,	
GTIN (EAN)	4008190264208	180°, Flat-blade connection, Solder connection, Box	
Qty.	36 ST		

## SLZF 5.08/90



Male plugs with tension-clamp wire connection. The male plugs provide space for labelling and can be coded.

## General ordering data

Type	SLZF 5.08/05/90 SN OR BX	Version	
Order No.	<a href="#">1673120000</a>	PCB plug-in connector, male plug, 5.08 mm, Number of poles: 5, 90°,	
GTIN (EAN)	4008190434830	Tension-clamp connection, Clamping range, max. : 3.31 mm², Box	
Qty.	50 ST		

## SLZF 5.08/180

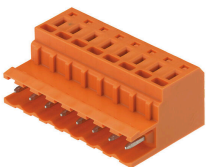

Male plugs with tension-clamp wire connection. The male plugs provide space for labelling and can be coded.

## General ordering data

Type	SLZF 5.08/05/180 SN OR ...	Version	
Order No.	<a href="#">1709400000</a>	PCB plug-in connector, male plug, 5.08 mm, Number of poles: 5,	
GTIN (EAN)	4008190390167	180°, Tension-clamp connection, Clamping range, max. : 3.31 mm²,	
Qty.	50 ST	Box	

## BLL 5.08/05/90 4.5 SN BK BX

**Weidmüller Interface GmbH & Co. KG**  
 Klingenbergstraße 26  
 D-32758 Detmold  
 Germany

## Counterpart

www.weidmueller.com

Type	SLZF 5.08/05/180 SN BK ...	Version
Order No.	<a href="#">1709630000</a>	PCB plug-in connector, male plug, 5.08 mm, Number of poles: 5,
GTIN (EAN)	4008190318932	180°, Tension-clamp connection, Clamping range, max. : 3.31 mm²,
Qty.	50 ST	Box

## SL 5.08/90



Male connectors with 90° outlet direction. The solder pin length is optimised for wave flow soldering. The pin headers provide space for labelling and can be coded.

### General ordering data

Type	SL 5.08/05/90 3.2SN DKG...	Version
Order No.	<a href="#">1508350000</a>	PCB plug-in connector, male header, open side, THT solder
GTIN (EAN)	4008190008383	connection, 5.08 mm, Number of poles: 5, 90°, Solder pin length (l):
Qty.	50 ST	3.2 mm, tinned, Signal green, Box
Type	SL 5.08/05/90 3.2SN OR ...	Version
Order No.	<a href="#">1508360000</a>	PCB plug-in connector, male header, open side, THT solder
GTIN (EAN)	4008190131241	connection, 5.08 mm, Number of poles: 5, 90°, Solder pin length (l):
Qty.	50 ST	3.2 mm, tinned, orange, Box
Type	SL 5.08/05/90 4.5SN BK ...	Version
Order No.	<a href="#">1512910000</a>	PCB plug-in connector, male header, open side, THT solder
GTIN (EAN)	4008190292508	connection, 5.08 mm, Number of poles: 5, 90°, Solder pin length (l):
Qty.	50 ST	4.5 mm, tinned, black, Box
Type	SL 5.08/05/90 4.5SN OR ...	Version
Order No.	<a href="#">1512960000</a>	PCB plug-in connector, male header, open side, THT solder
GTIN (EAN)	4008190110222	connection, 5.08 mm, Number of poles: 5, 90°, Solder pin length (l):
Qty.	50 ST	4.5 mm, tinned, orange, Box

## SL 5.08/180

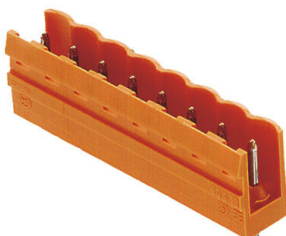

Male connectors with straight outlet direction. The solder pin length is optimised for wave flow soldering. The pin headers provide space for labelling and can be coded.

### General ordering data

Type	SL 5.08/05/180 3.2SN DK...	Version
Order No.	<a href="#">1517550000</a>	PCB plug-in connector, male header, open side, THT solder
GTIN (EAN)	4008190131487	connection, 5.08 mm, Number of poles: 5, 180°, Solder pin length (l):
Qty.	50 ST	3.2 mm, tinned, Signal green, Box

## BLL 5.08/05/90 4.5 SN BK BX

**Weidmüller Interface GmbH & Co. KG**  
 Klingenbergstraße 26  
 D-32758 Detmold  
 Germany

www.weidmueller.com

## Counterpart

Type	SL 5.08/05/180 3.2SN OR...	Version
Order No.	<a href="#">1517560000</a>	PCB plug-in connector, male header, open side, THT solder
GTIN (EAN)	4008190145170	connection, 5.08 mm, Number of poles: 5, 180°, Solder pin length (l):
Qty.	50 ST	3.2 mm, tinned, orange, Box
Type	SL 5.08/05/180 4.5SN BK...	Version
Order No.	<a href="#">1522110000</a>	PCB plug-in connector, male header, open side, THT solder
GTIN (EAN)	4008190291556	connection, 5.08 mm, Number of poles: 5, 180°, Solder pin length (l):
Qty.	50 ST	4.5 mm, tinned, black, Box
Type	SL 5.08/05/180 4.5SN OR...	Version
Order No.	<a href="#">1522160000</a>	PCB plug-in connector, male header, open side, THT solder
GTIN (EAN)	4008190047344	connection, 5.08 mm, Number of poles: 5, 180°, Solder pin length (l):
Qty.	50 ST	4.5 mm, tinned, orange, Box

## SL 5.00/90

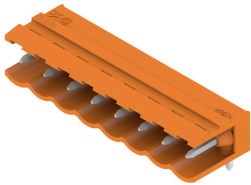

Male connectors with 90° outlet direction. The solder pin length is optimised for wave flow soldering. The pin headers provide space for labelling and can be coded.

### General ordering data

Type	SL 5.00/05/90 3.2SN OR ...	Version
Order No.	<a href="#">1571160000</a>	PCB plug-in connector, male header, open side, THT solder
GTIN (EAN)	4008190128463	connection, 5.00 mm, Number of poles: 5, 90°, Solder pin length (l):
Qty.	50 ST	3.2 mm, tinned, orange, Box

## SLDF 5.08

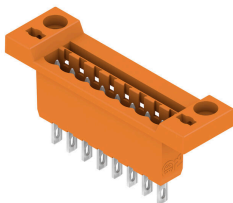

Male connector for through-panel mounting with optional locking function. Internal connection as flat-blade or solder connection. These male connectors provide space for labelling and can be coded.

### General ordering data

Type	SLDF 5.08 L/F 5 SN OR BX	Version
Order No.	<a href="#">1599160000</a>	PCB plug-in connector, male header, 5.08 mm, Number of poles: 5,
GTIN (EAN)	4008190079970	180°, Flat-blade connection, Solder connection, Box
Qty.	36 ST	

## BLL 5.08/05/90 4.5 SN BK BX

**Weidmüller Interface GmbH & Co. KG**  
 Klingenbergstraße 26  
 D-32758 Detmold  
 Germany

www.weidmueller.com

## Counterpart

## SLD 5.08/90G

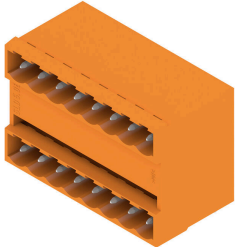

2-tier male header with parallel pin arrangement. The solder pin length is optimised for wave flow soldering. The pin headers provide space for labelling and can be coded.

## General ordering data

Type	SLD 5.08/10/90G 3.2SN O...	Version
Order No.	<a href="#">1601820000</a>	PCB plug-in connector, male header, closed side, THT solder
GTIN (EAN)	4008190091026	connection, 5.08 mm, Number of poles: 10, 90°, Solder pin length (l):
Qty.	50 ST	3.2 mm, tinned, orange, Box

## SLD 5.08/180G

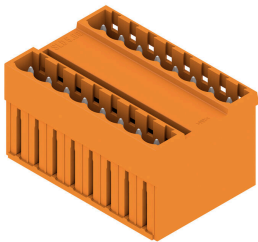

2-tier male header with parallel pin arrangement. The solder pin length is optimised for wave flow soldering. The pin headers provide space for labelling and can be coded.

## General ordering data

Type	SLD 5.08/10/180G 3.2SN ...	Version
Order No.	<a href="#">1602420000</a>	PCB plug-in connector, male header, closed side, THT solder
GTIN (EAN)	4008190077129	connection, 5.08 mm, Number of poles: 10, 180°, Solder pin length
Qty.	50 ST	(l): 3.2 mm, tinned, orange, Box

## SL 5.08/135



Male connectors with 135° outlet direction. The solder pin length is optimised for wave flow soldering. The pin headers provide space for labelling and can be coded.

## General ordering data

Type	SL 5.08/05/135 3.2SN OR...	Version
Order No.	<a href="#">1603090000</a>	PCB plug-in connector, male header, open side, THT solder
GTIN (EAN)	4008190013912	connection, 5.08 mm, Number of poles: 5, 135°, Solder pin length (l):
Qty.	50 ST	3.2 mm, tinned, orange, Box

## BLL 5.08/05/90 4.5 SN BK BX

**Weidmüller Interface GmbH & Co. KG**  
Klingenbergstraße 26  
D-32758 Detmold  
Germany

www.weidmueller.com

## Counterpart

### SL-SMT 5.08/180 Box

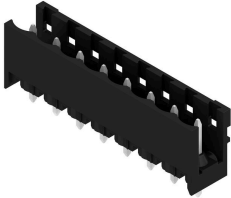

High-temperature-resistant, straight, open pin header. Packed in box or tape. On tape and with 1.5 mm solder pin, optimised for automatic assembly. 3.2 mm solder pin suitable for reflow and wave soldering. The pin headers provide space for labelling and can be coded. HC = High Current.

#### General ordering data

Type	SL-SMT 5.08HC/05/180 3...	Version
Order No.	<a href="#">1838010000</a>	PCB plug-in connector, male header, open side, THT/THR solder
GTIN (EAN)	4032248348077	connection, 5.08 mm, Number of poles: 5, 180°, Solder pin length (l):
Qty.	50 ST	3.2 mm, tinned, black, Box

### SL-SMT 5.08/180G Box

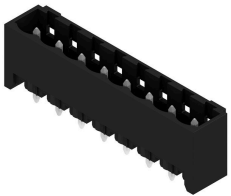

High-temperature-resistant pin header, packed in box or tape. On tape, with 1.5 mm solder pin, optimised for automatic assembly. 3.2 mm solder pin suitable for reflow and wave soldering. The pin headers provide space for labelling and can be coded. HC = High Current.

#### General ordering data

Type	SL-SMT 5.08HC/05/180G 3...	Version
Order No.	<a href="#">1838240000</a>	PCB plug-in connector, male header, closed side, THT/THR solder
GTIN (EAN)	4032248348305	connection, 5.08 mm, Number of poles: 5, 180°, Solder pin length (l):
Qty.	50 ST	3.2 mm, tinned, black, Box

### SL-SMT 5.08HC/90G Box



High-temperature-resistant pin header, packed in box or tape. On tape, with 1.5 mm solder pin, optimised for automatic assembly. 3.2 mm solder pin suitable for reflow and wave soldering. The pin headers provide space for labelling and can be coded. HC = High Current.

#### General ordering data

Type	SL-SMT 5.08HC/05/90G 3...	Version
Order No.	<a href="#">1780210000</a>	PCB plug-in connector, male header, closed side, THT/THR solder
GTIN (EAN)	4032248165537	connection, 5.08 mm, Number of poles: 5, 90°, Solder pin length (l):
Qty.	50 ST	3.2 mm, tinned, black, Box

## BLL 5.08/05/90 4.5 SN BK BX

**Weidmüller Interface GmbH & Co. KG**  
 Klingenbergstraße 26  
 D-32758 Detmold  
 Germany

www.weidmueller.com

## Counterpart

## SL-SMT 5.08/180G Tape

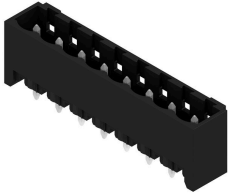

High-temperature-resistant pin header, packed in box or tape. On tape, with 1.5 mm solder pin, optimised for automatic assembly. 3.2 mm solder pin suitable for reflow and wave soldering. The pin headers provide space for labelling and can be coded. HC = High Current.

## General ordering data

Type	SL-SMT 5.08HC/05/180G 1...	Version
Order No.	<a href="#">1775954001</a>	PCB plug-in connector, male header, closed side, THT/THR solder connection, 5.08 mm, Number of poles: 5, 180°, Solder pin length (l):
GTIN (EAN)	4032248160143	
Qty.	250 ST	1.5 mm, tinned, black, Tape

## SL-SMT 5.08/180 Box

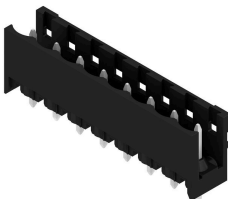

High-temperature-resistant, straight, open pin header. Packed in box or tape. On tape and with 1.5 mm solder pin, optimised for automatic assembly. 3.2 mm solder pin suitable for reflow and wave soldering. The pin headers provide space for labelling and can be coded. HC = High Current.

## General ordering data

Type	SL-SMT 5.08HC/05/180 1....	Version
Order No.	<a href="#">1775632001</a>	PCB plug-in connector, male header, open side, THT/THR solder connection, 5.08 mm, Number of poles: 5, 180°, Solder pin length (l):
GTIN (EAN)	4032248157570	
Qty.	50 ST	1.5 mm, tinned, black, Box

## SL-SMT 5.08HC/90 Box



High-temperature-resistant, 90° angled, open male header. Packed in box or tape. On tape, with 1.5 mm solder pin, optimised for automatic assembly. 3.2 mm solder pin suitable for reflow and wave soldering. The pin headers provide space for labelling and can be coded. HC = High Current.

## General ordering data

Type	SL-SMT 5.08HC/05/90 1.5...	Version
Order No.	<a href="#">1774792001</a>	PCB plug-in connector, male header, open side, THT/THR solder connection, 5.08 mm, Number of poles: 5, 90°, Solder pin length (l):
GTIN (EAN)	4032248155828	
Qty.	50 ST	1.5 mm, tinned, black, Box

## BLL 5.08/05/90 4.5 SN BK BX

**Weidmüller Interface GmbH & Co. KG**  
 Klingenbergstraße 26  
 D-32758 Detmold  
 Germany

www.weidmueller.com

## Counterpart

## SL-SMT 5.08/180 Tape

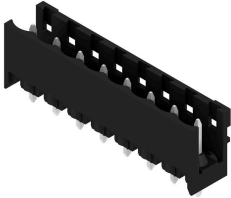

High-temperature-resistant, straight, open pin header. Packed in box or tape. On tape and with 1.5 mm solder pin, optimised for automatic assembly. 3.2 mm solder pin suitable for reflow and wave soldering. The pin headers provide space for labelling and can be coded. HC = High Current.

## General ordering data

Type	SL-SMT 5.08HC/05/180 1...	Version
Order No.	<a href="#">1775634001</a>	PCB plug-in connector, male header, open side, THT/THR solder
GTIN (EAN)	4032248 159611	connection, 5.08 mm, Number of poles: 5, 180°, Solder pin length (l):
Qty.	250 ST	1.5 mm, tinned, black, Tape

## SL-SMT 5.08/180G Box

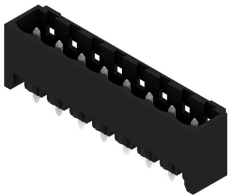

High-temperature-resistant pin header, packed in box or tape. On tape, with 1.5 mm solder pin, optimised for automatic assembly. 3.2 mm solder pin suitable for reflow and wave soldering. The pin headers provide space for labelling and can be coded. HC = High Current.

## General ordering data

Type	SL-SMT 5.08HC/05/180G 1...	Version
Order No.	<a href="#">1775952001</a>	PCB plug-in connector, male header, closed side, THT/THR solder
GTIN (EAN)	4032248 158942	connection, 5.08 mm, Number of poles: 5, 180°, Solder pin length (l):
Qty.	50 ST	1.5 mm, tinned, black, Box

## SL-SMT 5.08HC/90G Box



High-temperature-resistant pin header, packed in box or tape. On tape, with 1.5 mm solder pin, optimised for automatic assembly. 3.2 mm solder pin suitable for reflow and wave soldering. The pin headers provide space for labelling and can be coded. HC = High Current.

## General ordering data

Type	SL-SMT 5.08HC/05/90G 1...	Version
Order No.	<a href="#">1775032001</a>	PCB plug-in connector, male header, closed side, THT/THR solder
GTIN (EAN)	4032248 156092	connection, 5.08 mm, Number of poles: 5, 90°, Solder pin length (l):
Qty.	50 ST	1.5 mm, tinned, black, Box

## BLL 5.08/05/90 4.5 SN BK BX

**Weidmüller Interface GmbH & Co. KG**  
 Klingenbergstraße 26  
 D-32758 Detmold  
 Germany

www.weidmueller.com

## Counterpart

### SL-SMT 5.08HC/90 Tape



High-temperature-resistant, 90° angled, open male header. Packed in box or tape. On tape, with 1.5 mm solder pin, optimised for automatic assembly. 3.2 mm solder pin suitable for reflow and wave soldering. The pin headers provide space for labelling and can be coded. HC = High Current.

#### General ordering data

Type	SL-SMT 5.08HC/05/90 1.5...	Version
Order No.	<a href="#">1774794001</a>	PCB plug-in connector, male header, open side, THT/THR solder
GTIN (EAN)	4032248167685	connection, 5.08 mm, Number of poles: 5, 90°, Solder pin length (l):
Qty.	350 ST	1.5 mm, tinned, black, Tape

### SL-SMT 5.08HC/90G Tape



High-temperature-resistant pin header, packed in box or tape. On tape, with 1.5 mm solder pin, optimised for automatic assembly. 3.2 mm solder pin suitable for reflow and wave soldering. The pin headers provide space for labelling and can be coded. HC = High Current.

#### General ordering data

Type	SL-SMT 5.08HC/05/90G 1....	Version
Order No.	<a href="#">1775034001</a>	PCB plug-in connector, male header, closed side, THT/THR solder
GTIN (EAN)	4032248167753	connection, 5.08 mm, Number of poles: 5, 90°, Solder pin length (l):
Qty.	350 ST	1.5 mm, tinned, black, Tape

### SL-SMT 5.08HC/90 Box



High-temperature-resistant, 90° angled, open male header. Packed in box or tape. On tape, with 1.5 mm solder pin, optimised for automatic assembly. 3.2 mm solder pin suitable for reflow and wave soldering. The pin headers provide space for labelling and can be coded. HC = High Current.

#### General ordering data

Type	SL-SMT 5.08HC/05/90 3.2...	Version
Order No.	<a href="#">1779980000</a>	PCB plug-in connector, male header, open side, THT/THR solder
GTIN (EAN)	4032248165308	connection, 5.08 mm, Number of poles: 5, 90°, Solder pin length (l):
Qty.	50 ST	3.2 mm, tinned, black, Box