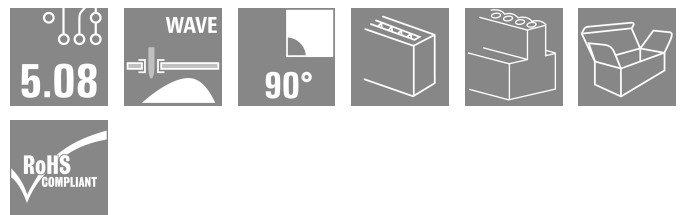
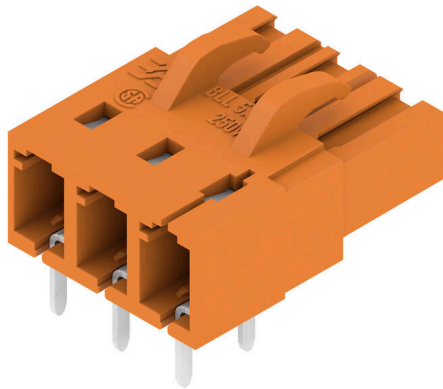

BLL 5.08/03/90 4.5 SN OR BX

Weidmüller Interface GmbH & Co. KG
 Klingenbergstraße 26
 D-32758 Detmold
 Germany

www.weidmueller.com

Product image

Female header for PCB mounting. The solder pin length is optimised for wave flow soldering.

General ordering data

Version	PCB plug-in connector, female header, closed side, THT solder connection, 5.08 mm, Number of poles: 3, 90°, Solder pin length (l): 4.5 mm, tinned, orange, Box
Order No.	1645930000
Type	BLL 5.08/03/90 4.5 SN OR BX
GTIN (EAN)	4008190285272
Qty.	120 items
Product data	IEC: 400 V / 23 A UL: 300 V / 15 A
Packaging	Box

BLL 5.08/03/90 4.5 SN OR BX

Weidmüller Interface GmbH & Co. KG
Klingenbergstraße 26
D-32758 Detmold
Germany

www.weidmueller.com

Technical data

Approvals

Approvals



ROHS	Conform
UL File Number Search	UL Website
Certificate No. (UR)	E60693

Dimensions and weights

Net weight	3.2 g
------------	-------

Environmental Product Compliance

RoHS Compliance Status	Compliant without exemption
REACH SVHC	No SVHC above 0.1 wt%

System specifications

Product family	OMNIMATE Signal - series BL/SL 5.08	Type of connection	Board connection
Mounting onto the PCB	THT solder connection	Pitch in mm (P)	5.08 mm
Pitch in inches (P)	0.200 "	Outgoing elbow	90°
Number of poles	3	Number of solder pins per pole	2
Solder pin length (l)	4.5 mm	Solder pin length tolerance	+0.1 / -0.3 mm
Solder pin dimensions	0.4 x 1.00 mm	Solder eyelet hole diameter (D)	1.3 mm
Solder eyelet hole diameter tolerance (D)+ 0,1 mm		L1 in mm	10.16 mm
L1 in inches	0.400 "	Number of rows	1
Pin series quantity	1	Touch-safe protection acc. to DIN VDE 57 106	Safe from back-of-hand touch
Touch-safe protection acc. to DIN VDE 0470	IP20 plugged	Protection degree	IP20
Volume resistance	≤5 mΩ	Can be coded	Yes
Plugging cycles	25	Plugging force/pole, max.	5 N
Pulling force/pole, max.	5 N		

Material data

Insulating material	PBT GF	Colour	orange
Colour chart (similar)	RAL 2000	Insulating material group	IIIa
Comparative Tracking Index (CTI)	≥ 200	Insulation resistance	108 Ω
Moisture Level (MSL)		UL 94 flammability rating	V-0
Contact material	Copper alloy	Contact surface	tinned
Layer structure of solder connection	4...6 μm Sn hot-dip tinned	Layer structure of plug contact	4...6 μm Sn hot-dip tinned
Storage temperature, min.	-40 °C	Storage temperature, max.	70 °C
Operating temperature, min.	-50 °C	Operating temperature, max.	100 °C
Temperature range, installation, min.	-25 °C	Temperature range, installation, max.	100 °C

Rated data acc. to IEC

tested acc. to standard	IEC 60664-1, IEC 61984	Rated current, min. number of poles (Tu=20°C)	23 A
Rated current, max. number of poles (Tu=20°C)	16 A	Rated current, min. number of poles (Tu=40°C)	20 A

BLL 5.08/03/90 4.5 SN OR BX

Weidmüller Interface GmbH & Co. KG

Klingenbergstraße 26
D-32758 Detmold
Germany

www.weidmueller.com

Technical data

Rated current, max. number of poles (Tu=40°C)	14 A	Rated voltage for surge voltage class / pollution degree II/2	400 V
Rated voltage for surge voltage class / pollution degree III/2	320 V	Rated voltage for surge voltage class / pollution degree III/3	250 V
Rated impulse voltage for surge voltage class/ pollution degree II/2	4 V	Rated impulse voltage for surge voltage class/ pollution degree III/2	4 kV
Rated impulse voltage for surge voltage class/ contamination degree III/3	4 kV	Short-time withstand current resistance	3 x 1s with 120 A

Rated data acc. to CSA

Institute (CSA)	CSA	Certificate No. (CSA)	200039-1121690
Rated voltage (Use group B / CSA)	300 V	Rated voltage (Use group D / CSA)	300 V
Rated current (Use group B / CSA)	15 A	Rated current (Use group D / CSA)	10 A
Reference to approval values	Specifications are maximum values, details - see approval certificate.		

Rated data acc. to UL 1059

Institute (UR)	UR	Certificate No. (UR)	E60693
Rated voltage (Use group B / UL 1059)	300 V	Rated voltage (Use group D / UL 1059)	300 V
Rated current (Use group B / UL 1059)	15 A	Rated current (Use group D / UL 1059)	10 A
Reference to approval values	Specifications are maximum values, details - see approval certificate.		

Packing

Packaging	Box	VPE length	350.00 mm
VPE width	135.00 mm	VPE height	30.00 mm

Important note

IPC conformity
Conformity: The products are developed, manufactured and delivered according international recognized standards and norms and comply with the assured properties in the data sheet resp. fulfill decorative properties in accordance with IPC-A-610 "Class 2". Further claims on the products can be evaluated on request.

- Notes
- Additional variants on request
 - Gold-plated contact surfaces on request
 - Rated current related to rated cross-section & min. No. of poles.
 - P on drawing = pitch
 - Rated data refer only to the component itself. Clearance and creepage distances to other components are to be designed in accordance with the relevant application standards.
 - In accordance with IEC 61984, OMNIMATE-connectors are connectors without breaking capacity (COC). During designated use, connectors are not allowed to be engaged or disengaged when live or under load
 - Long term storage of the product with average temperature of 50 °C and maximum humidity 70%, 36 months

Classifications

ETIM 8.0	EC002637	ETIM 9.0	EC002637
ETIM 10.0	EC002637	ECLASS 14.0	27-46-02-01
ECLASS 15.0	27-46-02-01		

Product image

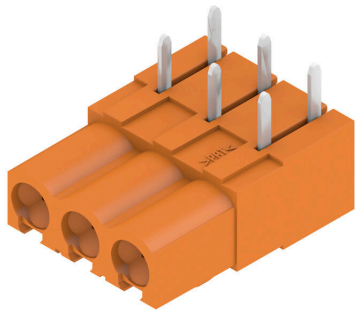

Dimensional drawing

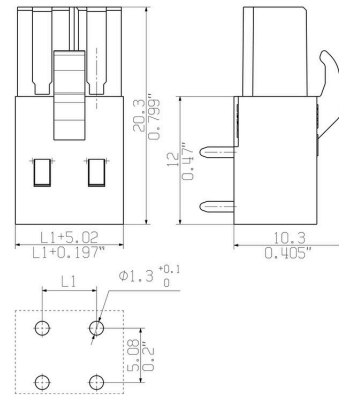

Example of use

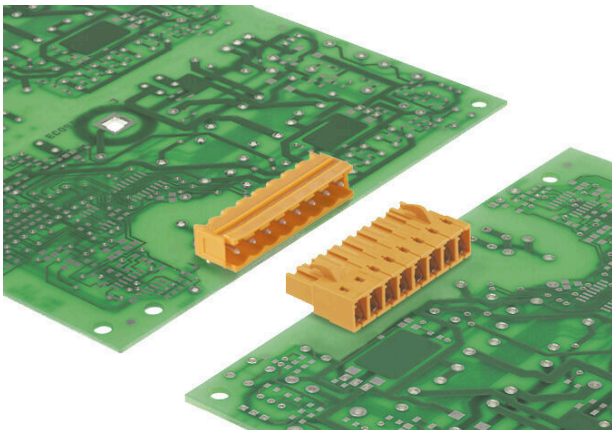

Coding elements



Only connects what is supposed to be connected: the right connection at the right place.
 Coding elements and locking devices clearly assign connecting elements during the manufacturing process and operation
 The coding elements and locking devices are inserted prior to assembly or during the cable assembly phase. The Weidmüller alternative: configure online using the variant configurator to precode prior to delivery. Incorrect assembly on the circuit board and incorrect plugging of connecting elements is no longer possible. The advantage: no troubleshooting during manufacture and no operational errors by the user.

General ordering data

Type	BLZ/SL KO BK BX	Version
Order No.	1545710000	PCB plug-in connector, Accessories, Coding element, black, Number
GTIN (EAN)	4008190087142	of poles: 1
Qty.	50 ST	
Type	BLZ/SL KO OR BX	Version
Order No.	1573010000	PCB plug-in connector, Accessories, Coding element, orange, Number
GTIN (EAN)	4008190048396	of poles: 1
Qty.	100 ST	

BLL 5.08/03/90 4.5 SN OR BX

Weidmüller Interface GmbH & Co. KG
 Klingenbergstraße 26
 D-32758 Detmold
 Germany

www.weidmueller.com

Counterpart

SL 5.00/90B

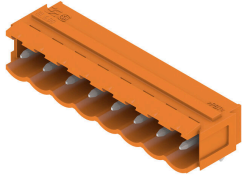

Male connectors with 90° outlet direction. The solder pin length is optimised for wave flow soldering. The pin headers provide space for labelling and can be coded.

General ordering data

Type	SL 5.00/03/90B 4.5SN BK...	Version
Order No.	1626220000	PCB plug-in connector, male header, Dovetails for fixing blocks, THT
GTIN (EAN)	4008190197520	solder connection, 5.00 mm, Number of poles: 3, 90°, Solder pin
Qty.	100 ST	length (l): 4.5 mm, tinned, black, Box

SLS 5.08/180B

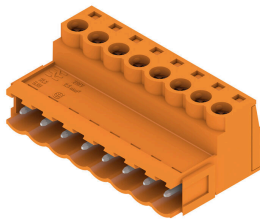

Male plugs with clamping-yoke screw wire-connect system. The male plugs provide space for labelling and can be coded.

General ordering data

Type	SLS 5.08/03/180B SN OR ...	Version
Order No.	1627250000	PCB plug-in connector, male plug, 5.08 mm, Number of poles: 3,
GTIN (EAN)	4008190199760	180°, Clamping yoke connection, Clamping range, max. : 3.31 mm²,
Qty.	108 ST	Box

SL 5.08/135B



Male connectors with 135° outlet direction. The solder pin length is optimised for wave flow soldering. The pin headers provide space for labelling and can be coded.

General ordering data

Type	SL 5.08/03/135B 4.5SN B...	Version
Order No.	1635510000	PCB plug-in connector, male header, Dovetails for fixing blocks, THT
GTIN (EAN)	4008190263942	solder connection, 5.08 mm, Number of poles: 3, 135°, Solder pin
Qty.	100 ST	length (l): 4.5 mm, tinned, black, Box

BLL 5.08/03/90 4.5 SN OR BX

Weidmüller Interface GmbH & Co. KG
Klingenbergstraße 26
D-32758 Detmold
Germany

www.weidmueller.com

Counterpart

SLS 5.08/180B

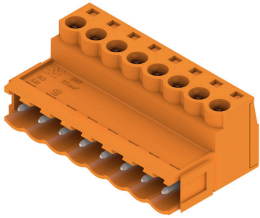

Male plugs with clamping-yoke screw wire-connect system. The male plugs provide space for labelling and can be coded.

General ordering data

Type	SLS 5.08/03/180B SN BK ...	Version
Order No.	1645240000	PCB plug-in connector, male plug, 5.08 mm, Number of poles: 3,
GTIN (EAN)	4008190284459	180°, Clamping yoke connection, Clamping range, max. : 3.31 mm ² ,
Qty.	108 ST	Box

SLZF 5.08/90B



Male plugs with tension-clamp wire connection. The male plugs provide space for labelling and can be coded.

General ordering data

Type	SLZF 5.08/03/90B SN OR ...	Version
Order No.	1673560000	PCB plug-in connector, male plug, 5.08 mm, Number of poles: 3, 90°,
GTIN (EAN)	4008190435271	Tension-clamp connection, Clamping range, max. : 3.31 mm ² , Box
Qty.	100 ST	

SLZF 5.08/270B



Male plugs with tension-clamp wire connection. The male plugs provide space for labelling and can be coded.

General ordering data

Type	SLZF 5.08/03/270B SN OR...	Version
Order No.	1706150000	PCB plug-in connector, male plug, 5.08 mm, Number of poles: 3,
GTIN (EAN)	4032248198009	270°, Tension-clamp connection, Clamping range, max. : 3.31 mm ² ,
Qty.	100 ST	Box

BLL 5.08/03/90 4.5 SN OR BX

Weidmüller Interface GmbH & Co. KG
Klingenbergstraße 26
D-32758 Detmold
Germany

www.weidmueller.com

Counterpart

SLZF 5.08/180B

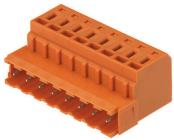

Male plugs with tension-clamp wire connection. The male plugs provide space for labelling and can be coded.

General ordering data

Type	SLZF 5.08/03/180B SN OR...	Version
Order No.	1710220000	PCB plug-in connector, male plug, 5.08 mm, Number of poles: 3,
GTIN (EAN)	4008190319533	180°, Tension-clamp connection, Clamping range, max. : 3.31 mm²,
Qty.	100 ST	Box
Type	SLZF 5.08/03/180B SN BK...	Version
Order No.	1710450000	PCB plug-in connector, male plug, 5.08 mm, Number of poles: 3,
GTIN (EAN)	4008190319762	180°, Tension-clamp connection, Clamping range, max. : 3.31 mm²,
Qty.	100 ST	Box

SL 5.08/90B

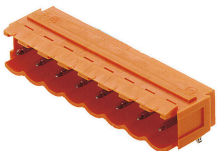

Male connectors with 90° outlet direction. The solder pin length is optimised for wave flow soldering. The pin headers provide space for labelling and can be coded.

General ordering data

Type	SL 5.08/03/90B 3.2SN BK...	Version
Order No.	1510410000	PCB plug-in connector, male header, Dovetails for fixing blocks, THT
GTIN (EAN)	4008190477677	solder connection, 5.08 mm, Number of poles: 3, 90°, Solder pin
Qty.	100 ST	length (l): 3.2 mm, tinned, black, Box
Type	SL 5.08/03/90B 3.2SN DK...	Version
Order No.	1510450000	PCB plug-in connector, male header, Dovetails for fixing blocks, THT
GTIN (EAN)	4008190292126	solder connection, 5.08 mm, Number of poles: 3, 90°, Solder pin
Qty.	100 ST	length (l): 3.2 mm, tinned, Signal green, Box
Type	SL 5.08/03/90B 3.2SN OR...	Version
Order No.	1510460000	PCB plug-in connector, male header, Dovetails for fixing blocks, THT
GTIN (EAN)	4008190054892	solder connection, 5.08 mm, Number of poles: 3, 90°, Solder pin
Qty.	100 ST	length (l): 3.2 mm, tinned, orange, Box
Type	SL 5.08/03/90B 3.2SN BL...	Version
Order No.	1510480000	PCB plug-in connector, male header, Dovetails for fixing blocks, THT
GTIN (EAN)	4008190286477	solder connection, 5.08 mm, Number of poles: 3, 90°, Solder pin
Qty.	100 ST	length (l): 3.2 mm, tinned, blue, Box

BLL 5.08/03/90 4.5 SN OR BX

Weidmüller Interface GmbH & Co. KG
 Klingenbergstraße 26
 D-32758 Detmold
 Germany

www.weidmueller.com

Counterpart

Type	SL 5.08/03/90B 4.5SN BK...	Version
Order No.	1515010000	PCB plug-in connector, male header, Dovetails for fixing blocks, THT
GTIN (EAN)	4008190114978	solder connection, 5.08 mm, Number of poles: 3, 90°, Solder pin
Qty.	100 ST	length (l): 4.5 mm, tinned, black, Box
Type	SL 5.08/03/90B 4.5SN OR...	Version
Order No.	1515060000	PCB plug-in connector, male header, Dovetails for fixing blocks, THT
GTIN (EAN)	4008190010126	solder connection, 5.08 mm, Number of poles: 3, 90°, Solder pin
Qty.	100 ST	length (l): 4.5 mm, tinned, orange, Box

SL 5.08/180B



Male connectors with straight outlet direction. The solder pin length is optimised for wave flow soldering. The pin headers provide space for labelling and can be coded.

General ordering data

Type	SL 5.08/03/180B 3.2SN B...	Version
Order No.	1519610000	PCB plug-in connector, male header, Dovetails for fixing blocks, THT
GTIN (EAN)	4008190294663	solder connection, 5.08 mm, Number of poles: 3, 180°, Solder pin
Qty.	100 ST	length (l): 3.2 mm, tinned, black, Box
Type	SL 5.08/03/180B 3.2SN D...	Version
Order No.	1519650000	PCB plug-in connector, male header, Dovetails for fixing blocks, THT
GTIN (EAN)	4008190291327	solder connection, 5.08 mm, Number of poles: 3, 180°, Solder pin
Qty.	100 ST	length (l): 3.2 mm, tinned, Signal green, Box
Type	SL 5.08/03/180B 3.2SN O...	Version
Order No.	1519660000	PCB plug-in connector, male header, Dovetails for fixing blocks, THT
GTIN (EAN)	4008190110024	solder connection, 5.08 mm, Number of poles: 3, 180°, Solder pin
Qty.	108 ST	length (l): 3.2 mm, tinned, orange, Box
Type	SL 5.08/03/180B 4.5SN B...	Version
Order No.	1524210000	PCB plug-in connector, male header, Dovetails for fixing blocks, THT
GTIN (EAN)	4008190139933	solder connection, 5.08 mm, Number of poles: 3, 180°, Solder pin
Qty.	100 ST	length (l): 4.5 mm, tinned, black, Box
Type	SL 5.08/03/180B 4.5SN O...	Version
Order No.	1524260000	PCB plug-in connector, male header, Dovetails for fixing blocks, THT
GTIN (EAN)	4008190095444	solder connection, 5.08 mm, Number of poles: 3, 180°, Solder pin
Qty.	100 ST	length (l): 4.5 mm, tinned, orange, Box

BLL 5.08/03/90 4.5 SN OR BX

Weidmüller Interface GmbH & Co. KG
 Klingenbergstraße 26
 D-32758 Detmold
 Germany

www.weidmueller.com

Counterpart

SL 5.00/90B

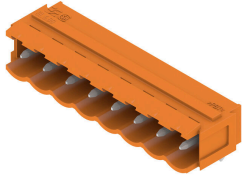

Male connectors with 90° outlet direction. The solder pin length is optimised for wave flow soldering. The pin headers provide space for labelling and can be coded.

General ordering data

Type	SL 5.00/03/90B 3.2SN OR...	Version
Order No.	1580870000	PCB plug-in connector, male header, Dovetails for fixing blocks, THT
GTIN (EAN)	4008190008482	solder connection, 5.00 mm, Number of poles: 3, 90°, Solder pin
Qty.	100 ST	length (l): 3.2 mm, tinned, orange, Box

SL 5.08/135B



Male connectors with 135° outlet direction. The solder pin length is optimised for wave flow soldering. The pin headers provide space for labelling and can be coded.

General ordering data

Type	SL 5.08/03/135B 3.2SN O...	Version
Order No.	1605540000	PCB plug-in connector, male header, Dovetails for fixing blocks, THT
GTIN (EAN)	4008190097059	solder connection, 5.08 mm, Number of poles: 3, 135°, Solder pin
Qty.	100 ST	length (l): 3.2 mm, tinned, orange, Box

SLT 5.08B

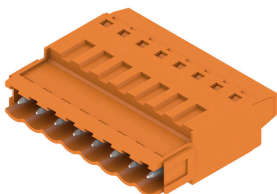

Male plugs with screw TOP wire connection. The male plug provides space for labelling and can be coded.

General ordering data

Type	SLT 5.08/03/180B SN OR ...	Version
Order No.	1611720000	PCB plug-in connector, male plug, 5.08 mm, Number of poles: 3,
GTIN (EAN)	4008190192600	180°, TOP connection, Clamping range, max.: 2.5 mm², Box
Qty.	100 ST	

BLL 5.08/03/90 4.5 SN OR BX

Weidmüller Interface GmbH & Co. KG
Klingenbergstraße 26
D-32758 Detmold
Germany

www.weidmueller.com

Counterpart

SLDV-THR 5.08/180F



High-temperature resistant, double level, laterally offset, male connector with flange or solder flange. 1.5 mm solder pin is suitable for reflow soldering. 3.2 mm solder pin suitable for reflow and wave soldering. The pin headers provide space for labelling and can be coded.

General ordering data

Type	SLDV-THR 5.08/06/180F 1...	Version
Order No.	1828900000	PCB plug-in connector, male header, Flange, THT/THR solder
GTIN (EAN)	4032248335596	connection, 5.08 mm, Number of poles: 6, 180°, Solder pin length (l):
Qty.	44 ST	1.5 mm, tinned, black, Box

SLDV-THR 5.08/180FLF



High-temperature resistant, double level, laterally offset, male connector with flange or solder flange. 1.5 mm solder pin is suitable for reflow soldering. 3.2 mm solder pin suitable for reflow and wave soldering. The pin headers provide space for labelling and can be coded.

General ordering data

Type	SLDV-THR 5.08/06/180FLF...	Version
Order No.	1829020000	PCB plug-in connector, male header, Flange / Solder flange, THT/THR
GTIN (EAN)	4032248335718	solder connection, 5.08 mm, Number of poles: 6, 180°, Solder pin
Qty.	44 ST	length (l): 3.2 mm, tinned, black, Box

SLDV-THR 5.08/180F



High-temperature resistant, double level, laterally offset, male connector with flange or solder flange. 1.5 mm solder pin is suitable for reflow soldering. 3.2 mm solder pin suitable for reflow and wave soldering. The pin headers provide space for labelling and can be coded.

General ordering data

Type	SLDV-THR 5.08/06/180F 3...	Version
Order No.	1828780000	PCB plug-in connector, male header, Flange, THT/THR solder
GTIN (EAN)	4032248335466	connection, 5.08 mm, Number of poles: 6, 180°, Solder pin length (l):
Qty.	44 ST	3.2 mm, tinned, black, Box

BLL 5.08/03/90 4.5 SN OR BX

Weidmüller Interface GmbH & Co. KG
Klingenbergstraße 26
D-32758 Detmold
Germany

www.weidmueller.com

Counterpart

SL-SMT 5.08HC/90F Box



High-temperature-resistant pin header, packed in box or tape. On tape, with 1.5 mm solder pin, optimised for automatic assembly. 3.2 mm solder pin suitable for reflow and wave soldering. The pin headers provide space for labelling and can be coded. HC = High Current.

General ordering data

Type	SL-SMT 5.08HC/03/90F 3...	Version
Order No.	1837640000	PCB plug-in connector, male header, Flange, THT/THR solder
GTIN (EAN)	4032248347452	connection, 5.08 mm, Number of poles: 3, 90°, Solder pin length (l):
Qty.	72 ST	3.2 mm, tinned, black, Box

SL-SMT 5.08/180LF Box



High-temperature-resistant pin header, packed in box or tape. On tape, with 1.5 mm solder pin, optimised for automatic assembly. 3.2 mm solder pin suitable for reflow and wave soldering. The pin headers provide space for labelling and can be coded. HC = High Current.

General ordering data

Type	SL-SMT 5.08HC/03/180LF ...	Version
Order No.	1838450000	PCB plug-in connector, male header, Solder flange, THT/THR solder
GTIN (EAN)	4032248348510	connection, 5.08 mm, Number of poles: 3, 180°, Solder pin length (l):
Qty.	72 ST	3.2 mm, tinned, black, Box

SL-SMT 5.00HC/90LF Box



High-temperature-resistant pin header, packed in box or tape. On tape, with 1.5 mm solder pin, optimised for automatic assembly. 3.2 mm solder pin suitable for reflow and wave soldering. The pin headers provide space for labelling and can be coded. HC = High Current.

General ordering data

Type	SL-SMT 5.00HC/03/90LF 3...	Version
Order No.	1840360000	PCB plug-in connector, male header, Solder flange, THT/THR solder
GTIN (EAN)	4032248351107	connection, 5.00 mm, Number of poles: 3, 90°, Solder pin length (l):
Qty.	72 ST	3.2 mm, tinned, black, Box

BLL 5.08/03/90 4.5 SN OR BX

Weidmüller Interface GmbH & Co. KG
 Klingenbergstraße 26
 D-32758 Detmold
 Germany

www.weidmueller.com

Counterpart

SLZF 5.08/180F

Male plugs with tension-clamp wire connection. The male plugs provide space for labelling and can be coded.

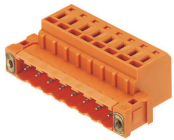

General ordering data

Type	SLZF 5.08/03/180F SN OR...	Version
Order No.	1846940000	PCB plug-in connector, male plug, 5.08 mm, Number of poles: 3,
GTIN (EAN)	4032248363117	180°, Tension-clamp connection, Clamping range, max. : 3.31 mm²,
Qty.	100 ST	Box

SLS 5.08/180FI

Male plugs with clamping-yoke screw wire-connect system. The male plugs provide space for labelling and can be coded.

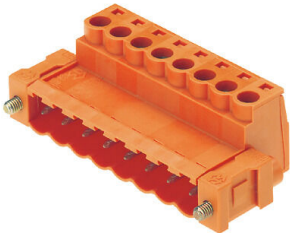

General ordering data

Type	SLS 5.08/03/180FI SN OR...	Version
Order No.	1846220000	PCB plug-in connector, male plug, 5.08 mm, Number of poles: 3,
GTIN (EAN)	4032248362509	180°, Clamping yoke connection, Clamping range, max. : 3.31 mm²,
Qty.	72 ST	Box

SLZF 5.08/180FI

Male plugs with tension-clamp wire connection. The male plugs provide space for labelling and can be coded.



General ordering data

Type	SLZF 5.08/03/180FI SN O...	Version
Order No.	1846520000	PCB plug-in connector, male plug, 5.08 mm, Number of poles: 3,
GTIN (EAN)	4032248362820	180°, Tension-clamp connection, Clamping range, max. : 3.31 mm²,
Qty.	100 ST	Box

BLL 5.08/03/90 4.5 SN OR BX

Weidmüller Interface GmbH & Co. KG
 Klingenbergstraße 26
 D-32758 Detmold
 Germany

Counterpart

www.weidmueller.com

SLS 5.08/180F



Male plugs with clamping-yoke screw wire-connect system. The male plugs provide space for labelling and can be coded.

General ordering data

Type	SLS 5.08/03/180F SN OR ...	Version
Order No.	1846370000	PCB plug-in connector, male plug, 5.08 mm, Number of poles: 3,
GTIN (EAN)	4032248362073	180°, Clamping yoke connection, Clamping range, max. : 3.31 mm²,
Qty.	72 ST	Box

SL-SMT 5.08HC/90LF Tape



High-temperature-resistant pin header, packed in box or tape. On tape, with 1.5 mm solder pin, optimised for automatic assembly. 3.2 mm solder pin suitable for reflow and wave soldering. The pin headers provide space for labelling and can be coded. HC = High Current.

General ordering data

Type	SL-SMT 5.08HC/03/90LF 1...	Version
Order No.	1775244001	PCB plug-in connector, male header, Solder flange, THT/THR solder
GTIN (EAN)	4032248167791	connection, 5.08 mm, Number of poles: 3, 90°, Solder pin length (l):
Qty.	350 ST	1.5 mm, tinned, black, Tape

SL-SMT 5.08/180LF Box

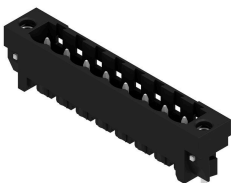

High-temperature-resistant pin header, packed in box or tape. On tape, with 1.5 mm solder pin, optimised for automatic assembly. 3.2 mm solder pin suitable for reflow and wave soldering. The pin headers provide space for labelling and can be coded. HC = High Current.

General ordering data

Type	SL-SMT 5.08HC/03/180LF ...	Version
Order No.	1776372001	PCB plug-in connector, male header, Solder flange, THT/THR solder
GTIN (EAN)	4032248159154	connection, 5.08 mm, Number of poles: 3, 180°, Solder pin length (l):
Qty.	72 ST	1.5 mm, tinned, black, Box

BLL 5.08/03/90 4.5 SN OR BX

Weidmüller Interface GmbH & Co. KG
Klingenbergstraße 26
D-32758 Detmold
Germany

Counterpart

www.weidmueller.com

SL-SMaT 5.0xHC/90 Tape

High-temperature resistant, modular pin header. Packed in tape with 1.5mm solder pin, optimised for automatic assembly and suitable for reflow soldering. The male connectors provide space for labelling and can be coded. HC = High Current.

General ordering data

Type	SL-SMaT 5.0xHC/03/90 1...	Version
Order No.	1812440000	PCB plug-in connector, male header, open side, THT/THR solder
GTIN (EAN)	4032248294022	connection, 5.08 mm, Number of poles: 3, 90°, Solder pin length (l):
Qty.	350 ST	1.5 mm, tinned, black, Tape

SL-SMT 5.08HC/90LF Box



High-temperature-resistant pin header, packed in box or tape. On tape, with 1.5 mm solder pin, optimised for automatic assembly. 3.2 mm solder pin suitable for reflow and wave soldering. The pin headers provide space for labelling and can be coded. HC = High Current.

General ordering data

Type	SL-SMT 5.08HC/03/90LF 1...	Version
Order No.	1775242001	PCB plug-in connector, male header, Solder flange, THT/THR solder
GTIN (EAN)	4032248157228	connection, 5.08 mm, Number of poles: 3, 90°, Solder pin length (l):
Qty.	72 ST	1.5 mm, tinned, black, Box

SL-SMT 5.08/180LF Tape

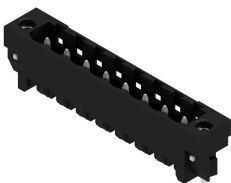

High-temperature-resistant pin header, packed in box or tape. On tape, with 1.5 mm solder pin, optimised for automatic assembly. 3.2 mm solder pin suitable for reflow and wave soldering. The pin headers provide space for labelling and can be coded. HC = High Current.

General ordering data

Type	SL-SMT 5.08HC/03/180LF ...	Version
Order No.	1776374001	PCB plug-in connector, male header, Solder flange, THT/THR solder
GTIN (EAN)	4032248163496	connection, 5.08 mm, Number of poles: 3, 180°, Solder pin length (l):
Qty.	250 ST	1.5 mm, tinned, black, Tape

BLL 5.08/03/90 4.5 SN OR BX

Weidmüller Interface GmbH & Co. KG
 Klingenbergstraße 26
 D-32758 Detmold
 Germany

www.weidmueller.com

Counterpart

SL-SMT 5.00HC/90LF Tape



High-temperature-resistant pin header, packed in box or tape. On tape, with 1.5 mm solder pin, optimised for automatic assembly. 3.2 mm solder pin suitable for reflow and wave soldering. The pin headers provide space for labelling and can be coded. HC = High Current.

General ordering data

Type	SL-SMT 5.00HC/03/90LF 1...	Version
Order No.	1797760000	PCB plug-in connector, male header, Solder flange, THT/THR solder
GTIN (EAN)	4032248239764	connection, 5.00 mm, Number of poles: 3, 90°, Solder pin length (l):
Qty.	350 ST	1.5 mm, tinned, black, Tape

SL-SMT 5.00HC/90LF Box



High-temperature-resistant pin header, packed in box or tape. On tape, with 1.5 mm solder pin, optimised for automatic assembly. 3.2 mm solder pin suitable for reflow and wave soldering. The pin headers provide space for labelling and can be coded. HC = High Current.

General ordering data

Type	SL-SMT 5.00HC/03/90LF 1...	Version
Order No.	1797240000	PCB plug-in connector, male header, Solder flange, THT/THR solder
GTIN (EAN)	4032248238026	connection, 5.00 mm, Number of poles: 3, 90°, Solder pin length (l):
Qty.	100 ST	1.5 mm, tinned, black, Box

SL-SMaRT 5.0xHC/180 Tape

High-temperature resistant, modular pin header. Packed in tape with 1.5mm solder pin, optimised for automatic assembly and suitable for reflow soldering. The male connectors provide space for labelling and can be coded. HC = High Current.

General ordering data

Type	SL-SMaRT 5.0xHC/03/180 ...	Version
Order No.	1812460000	PCB plug-in connector, male header, open side, THT/THR solder
GTIN (EAN)	4032248294046	connection, 5.08 mm, Number of poles: 3, 180°, Solder pin length (l):
Qty.	270 ST	1.5 mm, tinned, black, Tape

BLL 5.08/03/90 4.5 SN OR BX

Weidmüller Interface GmbH & Co. KG
Klingenbergstraße 26
D-32758 Detmold
Germany

www.weidmueller.com

Counterpart

SL-SMT 5.08HC/90LF Box



High-temperature-resistant pin header, packed in box or tape. On tape, with 1.5 mm solder pin, optimised for automatic assembly. 3.2 mm solder pin suitable for reflow and wave soldering. The pin headers provide space for labelling and can be coded. HC = High Current.

General ordering data

Type	SL-SMT 5.08HC/03/90LF 3...	Version
Order No.	1780420000	PCB plug-in connector, male header, Solder flange, THT/THR solder
GTIN (EAN)	4032248165742	connection, 5.08 mm, Number of poles: 3, 90°, Solder pin length (l):
Qty.	72 ST	3.2 mm, tinned, black, Box

SL-SMT 5.08/180F Box



High-temperature-resistant pin header, packed in box or tape. On tape, with 1.5 mm solder pin, optimised for automatic assembly. 3.2 mm solder pin suitable for reflow and wave soldering. The pin headers provide space for labelling and can be coded. HC = High Current.

General ordering data

Type	SL-SMT 5.08HC/03/180F 3...	Version
Order No.	1820600000	PCB plug-in connector, male header, Flange, THT/THR solder
GTIN (EAN)	4032248316564	connection, 5.08 mm, Number of poles: 3, 180°, Solder pin length (l):
Qty.	72 ST	3.2 mm, tinned, black, Box

SL 5.00/90

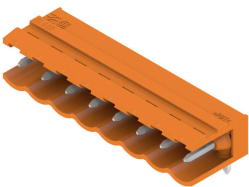

Male connectors with 90° outlet direction. The solder pin length is optimised for wave flow soldering. The pin headers provide space for labelling and can be coded.

General ordering data

Type	SL 5.00/03/90 4.5SN BK ...	Version
Order No.	1626000000	PCB plug-in connector, male header, open side, THT solder
GTIN (EAN)	4008190197308	connection, 5.00 mm, Number of poles: 3, 90°, Solder pin length (l):
Qty.	100 ST	4.5 mm, tinned, black, Box

BLL 5.08/03/90 4.5 SN OR BX

Weidmüller Interface GmbH & Co. KG
Klingenbergstraße 26
D-32758 Detmold
Germany

www.weidmueller.com

Counterpart

SLS 5.08/180 SN

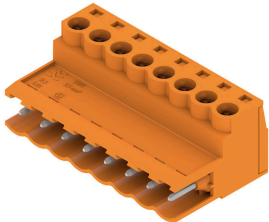

Male plugs with clamping-yoke screw wire-connect system. The male plugs provide space for labelling and can be coded.

General ordering data

Type	SLS 5.08/03/180 SN OR BX	Version	
Order No.	1627100000	PCB plug-in connector, male plug, 5.08 mm, Number of poles: 3,	
GTIN (EAN)	4008190199616	180°, Clamping yoke connection, Clamping range, max. : 3.31 mm ² ,	
Qty.	120 ST	Box	

SLDF 5.08

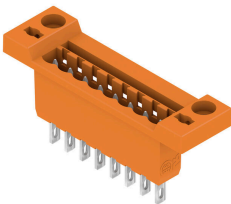

Male connector for through-panel mounting with optional locking function. Internal connection as flat-blade or solder connection. These male connectors provide space for labelling and can be coded.

General ordering data

Type	SLDF 5.08 L/F 3 SN BK BX	Version	
Order No.	1635750000	PCB plug-in connector, male header, 5.08 mm, Number of poles: 3,	
GTIN (EAN)	4008190264185	180°, Flat-blade connection, Solder connection, Box	
Qty.	48 ST		

SLS 5.08/180 SN

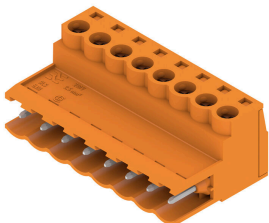

Male plugs with clamping-yoke screw wire-connect system. The male plugs provide space for labelling and can be coded.

General ordering data

Type	SLS 5.08/03/180 SN BK BX	Version	
Order No.	1644930000	PCB plug-in connector, male plug, 5.08 mm, Number of poles: 3,	
GTIN (EAN)	4008190284145	180°, Clamping yoke connection, Clamping range, max. : 3.31 mm ² ,	
Qty.	120 ST	Box	

BLL 5.08/03/90 4.5 SN OR BX

Weidmüller Interface GmbH & Co. KG
 Klingenbergstraße 26
 D-32758 Detmold
 Germany

www.weidmueller.com

Counterpart

SLZF 5.08/90



Male plugs with tension-clamp wire connection. The male plugs provide space for labelling and can be coded.

General ordering data

Type	SLZF 5.08/03/90 SN OR BX	Version	
Order No.	1673100000	PCB plug-in connector, male plug, 5.08 mm, Number of poles: 3, 90°,	
GTIN (EAN)	4008190434809	Tension-clamp connection, Clamping range, max. : 3.31 mm², Box	
Qty.	100 ST		

SLZF 5.08/180

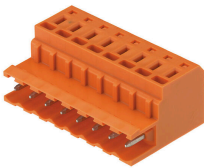

Male plugs with tension-clamp wire connection. The male plugs provide space for labelling and can be coded.

General ordering data

Type	SLZF 5.08/03/180 SN OR ...	Version	
Order No.	1709380000	PCB plug-in connector, male plug, 5.08 mm, Number of poles: 3,	
GTIN (EAN)	4008190395896	180°, Tension-clamp connection, Clamping range, max. : 3.31 mm²,	
Qty.	100 ST	Box	
Type	SLZF 5.08/03/180 SN BK ...	Version	
Order No.	1709610000	PCB plug-in connector, male plug, 5.08 mm, Number of poles: 3,	
GTIN (EAN)	4008190318918	180°, Tension-clamp connection, Clamping range, max. : 3.31 mm²,	
Qty.	100 ST	Box	

SL 5.08/90

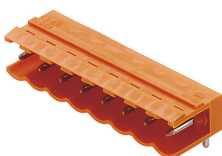

Male connectors with 90° outlet direction. The solder pin length is optimised for wave flow soldering. The pin headers provide space for labelling and can be coded.

BLL 5.08/03/90 4.5 SN OR BX

Weidmüller Interface GmbH & Co. KG
 Klingenbergstraße 26
 D-32758 Detmold
 Germany

Counterpart

www.weidmueller.com

General ordering data

Type	SL 5.08/03/90 3.2SN BK ...	Version
Order No.	1508110000	PCB plug-in connector, male header, open side, THT solder
GTIN (EAN)	4008190095086	connection, 5.08 mm, Number of poles: 3, 90°, Solder pin length (l):
Qty.	100 ST	3.2 mm, tinned, black, Box
Type	SL 5.08/03/90 3.2SN DKG...	Version
Order No.	1508150000	PCB plug-in connector, male header, open side, THT solder
GTIN (EAN)	4008190291761	connection, 5.08 mm, Number of poles: 3, 90°, Solder pin length (l):
Qty.	100 ST	3.2 mm, tinned, Signal green, Box
Type	SL 5.08/03/90 3.2SN OR ...	Version
Order No.	1508160000	PCB plug-in connector, male header, open side, THT solder
GTIN (EAN)	4008190028879	connection, 5.08 mm, Number of poles: 3, 90°, Solder pin length (l):
Qty.	100 ST	3.2 mm, tinned, orange, Box
Type	SL 5.08/03/90 4.5SN BK ...	Version
Order No.	1512710000	PCB plug-in connector, male header, open side, THT solder
GTIN (EAN)	4008190275860	connection, 5.08 mm, Number of poles: 3, 90°, Solder pin length (l):
Qty.	100 ST	4.5 mm, tinned, black, Box
Type	SL 5.08/03/90 4.5SN OR ...	Version
Order No.	1512760000	PCB plug-in connector, male header, open side, THT solder
GTIN (EAN)	4008190036089	connection, 5.08 mm, Number of poles: 3, 90°, Solder pin length (l):
Qty.	100 ST	4.5 mm, tinned, orange, Box

SL 5.08/180

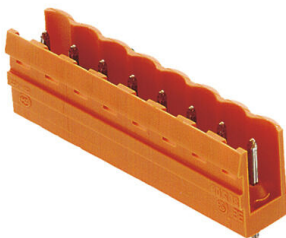

Male connectors with straight outlet direction. The solder pin length is optimised for wave flow soldering. The pin headers provide space for labelling and can be coded.

General ordering data

Type	SL 5.08/03/180 3.2SN BK...	Version
Order No.	1517310000	PCB plug-in connector, male header, open side, THT solder
GTIN (EAN)	4008190192990	connection, 5.08 mm, Number of poles: 3, 180°, Solder pin length (l):
Qty.	100 ST	3.2 mm, tinned, black, Box
Type	SL 5.08/03/180 3.2SN DK...	Version
Order No.	1517350000	PCB plug-in connector, male header, open side, THT solder
GTIN (EAN)	4008190111199	connection, 5.08 mm, Number of poles: 3, 180°, Solder pin length (l):
Qty.	100 ST	3.2 mm, tinned, Signal green, Box
Type	SL 5.08/03/180 3.2SN OR...	Version
Order No.	1517360000	PCB plug-in connector, male header, open side, THT solder
GTIN (EAN)	4008190057077	connection, 5.08 mm, Number of poles: 3, 180°, Solder pin length (l):
Qty.	100 ST	3.2 mm, tinned, orange, Box
Type	SL 5.08/03/180 4.5SN BK...	Version
Order No.	1521910000	PCB plug-in connector, male header, open side, THT solder
GTIN (EAN)	4008190177928	connection, 5.08 mm, Number of poles: 3, 180°, Solder pin length (l):
Qty.	100 ST	4.5 mm, tinned, black, Box

BLL 5.08/03/90 4.5 SN OR BX

Weidmüller Interface GmbH & Co. KG
 Klingenbergstraße 26
 D-32758 Detmold
 Germany

www.weidmueller.com

Counterpart

Type	SL 5.08/03/180 4.5SN OR...	Version
Order No.	1521960000	PCB plug-in connector, male header, open side, THT solder
GTIN (EAN)	4008190090807	connection, 5.08 mm, Number of poles: 3, 180°, Solder pin length (l):
Qty.	100 ST	4.5 mm, tinned, orange, Box

SL 5.00/90

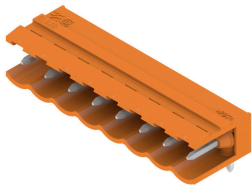

Male connectors with 90° outlet direction. The solder pin length is optimised for wave flow soldering. The pin headers provide space for labelling and can be coded.

General ordering data

Type	SL 5.00/03/90 3.2SN OR ...	Version
Order No.	1571140000	PCB plug-in connector, male header, open side, THT solder
GTIN (EAN)	4008190167202	connection, 5.00 mm, Number of poles: 3, 90°, Solder pin length (l):
Qty.	100 ST	3.2 mm, tinned, orange, Box

SLDF 5.08

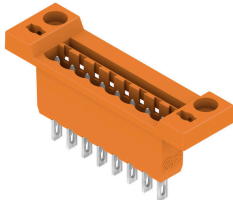

Male connector for through-panel mounting with optional locking function. Internal connection as flat-blade or solder connection. These male connectors provide space for labelling and can be coded.

General ordering data

Type	SLDF 5.08 L/F 3 SN OR BX	Version
Order No.	1599140000	PCB plug-in connector, male header, 5.08 mm, Number of poles: 3,
GTIN (EAN)	4008190077853	180°, Flat-blade connection, Solder connection, Box
Qty.	48 ST	

BLL 5.08/03/90 4.5 SN OR BX

Weidmüller Interface GmbH & Co. KG
 Klingenbergstraße 26
 D-32758 Detmold
 Germany

www.weidmueller.com

Counterpart

SLD 5.08/90G

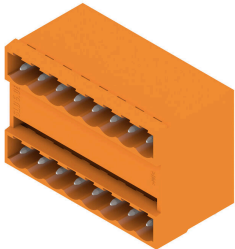

2-tier male header with parallel pin arrangement. The solder pin length is optimised for wave flow soldering. The pin headers provide space for labelling and can be coded.

General ordering data

Type	SLD 5.08/06/90G 3.2SN O...	Version
Order No.	1601800000	PCB plug-in connector, male header, closed side, THT solder
GTIN (EAN)	4008190045876	connection, 5.08 mm, Number of poles: 6, 90°, Solder pin length (l):
Qty.	50 ST	3.2 mm, tinned, orange, Box

SLD 5.08/180G

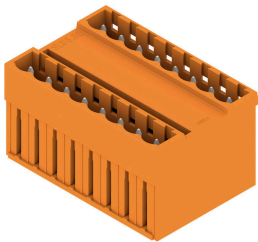

2-tier male header with parallel pin arrangement. The solder pin length is optimised for wave flow soldering. The pin headers provide space for labelling and can be coded.

General ordering data

Type	SLD 5.08/06/180G 3.2SN ...	Version
Order No.	1602400000	PCB plug-in connector, male header, closed side, THT solder
GTIN (EAN)	4008190076887	connection, 5.08 mm, Number of poles: 6, 180°, Solder pin length (l):
Qty.	50 ST	3.2 mm, tinned, orange, Box

SL 5.08/135



Male connectors with 135° outlet direction. The solder pin length is optimised for wave flow soldering. The pin headers provide space for labelling and can be coded.

General ordering data

Type	SL 5.08/03/135 3.2SN OR...	Version
Order No.	1603070000	PCB plug-in connector, male header, open side, THT solder
GTIN (EAN)	4008190089412	connection, 5.08 mm, Number of poles: 3, 135°, Solder pin length (l):
Qty.	100 ST	3.2 mm, tinned, orange, Box

BLL 5.08/03/90 4.5 SN OR BX

Weidmüller Interface GmbH & Co. KG
Klingenbergstraße 26
D-32758 Detmold
Germany

Counterpart

www.weidmueller.com

SLT 5.08/180

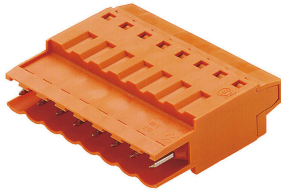

Male plugs with screw TOP wire connection. The male plug provides space for labelling and can be coded.

General ordering data

Type	SLT 5.08/03/180 SN OR BX	Version	
Order No.	1611570000	PCB plug-in connector, male plug, 5.08 mm, Number of poles: 3,	
GTIN (EAN)	4008190192457	180°, TOP connection, Clamping range, max.: 2.5 mm², Box	
Qty.	100 ST		

SL-SMT 5.08/180 Box

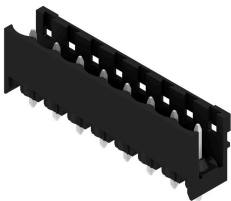

High-temperature-resistant, straight, open pin header. Packed in box or tape. On tape and with 1.5 mm solder pin, optimised for automatic assembly. 3.2 mm solder pin suitable for reflow and wave soldering. The pin headers provide space for labelling and can be coded. HC = High Current.

General ordering data

Type	SL-SMT 5.08HC/03/180 3...	Version	
Order No.	1837990000	PCB plug-in connector, male header, open side, THT/THR solder	
GTIN (EAN)	4032248348053	connection, 5.08 mm, Number of poles: 3, 180°, Solder pin length (l):	
Qty.	100 ST	3.2 mm, tinned, black, Box	

SL-SMT 5.08/180G Box

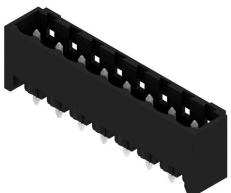

High-temperature-resistant pin header, packed in box or tape. On tape, with 1.5 mm solder pin, optimised for automatic assembly. 3.2 mm solder pin suitable for reflow and wave soldering. The pin headers provide space for labelling and can be coded. HC = High Current.

General ordering data

Type	SL-SMT 5.08HC/03/180G 3...	Version	
Order No.	1838220000	PCB plug-in connector, male header, closed side, THT/THR solder	
GTIN (EAN)	4032248348282	connection, 5.08 mm, Number of poles: 3, 180°, Solder pin length (l):	
Qty.	100 ST	3.2 mm, tinned, black, Box	

BLL 5.08/03/90 4.5 SN OR BX

Weidmüller Interface GmbH & Co. KG
 Klingenbergstraße 26
 D-32758 Detmold
 Germany

www.weidmueller.com

Counterpart

SL-SMT 5.08HC/90G Box



High-temperature-resistant pin header, packed in box or tape. On tape, with 1.5 mm solder pin, optimised for automatic assembly. 3.2 mm solder pin suitable for reflow and wave soldering. The pin headers provide space for labelling and can be coded. HC = High Current.

General ordering data

Type	SL-SMT 5.08HC/03/90G 3...	Version
Order No.	1780190000	PCB plug-in connector, male header, closed side, THT/THR solder
GTIN (EAN)	4032248165513	connection, 5.08 mm, Number of poles: 3, 90°, Solder pin length (l):
Qty.	100 ST	3.2 mm, tinned, black, Box

SL-SMT 5.08/180G Box

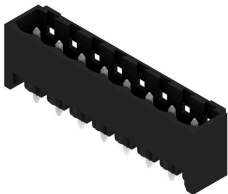

High-temperature-resistant pin header, packed in box or tape. On tape, with 1.5 mm solder pin, optimised for automatic assembly. 3.2 mm solder pin suitable for reflow and wave soldering. The pin headers provide space for labelling and can be coded. HC = High Current.

General ordering data

Type	SL-SMT 5.08HC/03/180G 1...	Version
Order No.	1775932001	PCB plug-in connector, male header, closed side, THT/THR solder
GTIN (EAN)	4032248158928	connection, 5.08 mm, Number of poles: 3, 180°, Solder pin length (l):
Qty.	100 ST	1.5 mm, tinned, black, Box

SL-SMT 5.08/180 Box

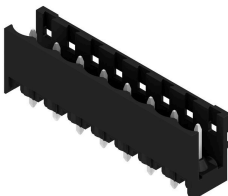

High-temperature-resistant, straight, open pin header. Packed in box or tape. On tape and with 1.5 mm solder pin, optimised for automatic assembly. 3.2 mm solder pin suitable for reflow and wave soldering. The pin headers provide space for labelling and can be coded. HC = High Current.

General ordering data

Type	SL-SMT 5.08HC/03/180 1...	Version
Order No.	1775572001	PCB plug-in connector, male header, open side, THT/THR solder
GTIN (EAN)	4032248157556	connection, 5.08 mm, Number of poles: 3, 180°, Solder pin length (l):
Qty.	100 ST	1.5 mm, tinned, black, Box

BLL 5.08/03/90 4.5 SN OR BX

Weidmüller Interface GmbH & Co. KG
Klingenbergstraße 26
D-32758 Detmold
Germany

www.weidmueller.com

Counterpart

SL-SMT 5.08HC/90G Tape



High-temperature-resistant pin header, packed in box or tape. On tape, with 1.5 mm solder pin, optimised for automatic assembly. 3.2 mm solder pin suitable for reflow and wave soldering. The pin headers provide space for labelling and can be coded. HC = High Current.

General ordering data

Type	SL-SMT 5.08HC/03/90G 1...	Version
Order No.	1775014001	PCB plug-in connector, male header, closed side, THT/THR solder connection, 5.08 mm, Number of poles: 3, 90°, Solder pin length (l):
GTIN (EAN)	4032248167739	1.5 mm, tinned, black, Tape
Qty.	350 ST	

SL-SMT 5.08HC/90B Tape



High-temperature-resistant, straight, open pin header. Packed in box or tape. On tape and with 1.5 mm solder pin, optimised for automatic assembly. 3.2 mm solder pin suitable for reflow and wave soldering. The pin headers provide space for labelling and can be coded. HC = High Current.

General ordering data

Type	SL-SMT 5.08HC/03/90B 1...	Version
Order No.	1804270000	PCB plug-in connector, male header, closed side, THT/THR solder connection, 5.08 mm, Number of poles: 3, 90°, Solder pin length (l):
GTIN (EAN)	4032248265725	1.5 mm, tinned, black, Tape
Qty.	350 ST	

SL-SMT 5.08HC/90 Box



High-temperature-resistant, 90° angled, open male header. Packed in box or tape. On tape, with 1.5 mm solder pin, optimised for automatic assembly. 3.2 mm solder pin suitable for reflow and wave soldering. The pin headers provide space for labelling and can be coded. HC = High Current.

General ordering data

Type	SL-SMT 5.08HC/03/90 1.5...	Version
Order No.	1774772001	PCB plug-in connector, male header, open side, THT/THR solder connection, 5.08 mm, Number of poles: 3, 90°, Solder pin length (l):
GTIN (EAN)	4032248155705	1.5 mm, tinned, black, Box
Qty.	100 ST	

BLL 5.08/03/90 4.5 SN OR BX

Weidmüller Interface GmbH & Co. KG
Klingenbergstraße 26
D-32758 Detmold
Germany

www.weidmueller.com

Counterpart

SL-SMT 5.08HC/90G Box



High-temperature-resistant pin header, packed in box or tape. On tape, with 1.5 mm solder pin, optimised for automatic assembly. 3.2 mm solder pin suitable for reflow and wave soldering. The pin headers provide space for labelling and can be coded. HC = High Current.

General ordering data

Type	SL-SMT 5.08HC/03/90G 1...	Version
Order No.	1775012001	PCB plug-in connector, male header, closed side, THT/THR solder
GTIN (EAN)	4032248156030	connection, 5.08 mm, Number of poles: 3, 90°, Solder pin length (l):
Qty.	100 ST	1.5 mm, tinned, black, Box

SL-SMT 5.08/180G Tape

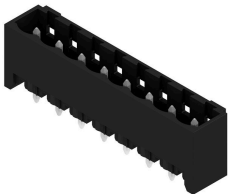

High-temperature-resistant pin header, packed in box or tape. On tape, with 1.5 mm solder pin, optimised for automatic assembly. 3.2 mm solder pin suitable for reflow and wave soldering. The pin headers provide space for labelling and can be coded. HC = High Current.

General ordering data

Type	SL-SMT 5.08HC/03/180G 1...	Version
Order No.	1775934001	PCB plug-in connector, male header, closed side, THT/THR solder
GTIN (EAN)	4032248160112	connection, 5.08 mm, Number of poles: 3, 180°, Solder pin length (l):
Qty.	250 ST	1.5 mm, tinned, black, Tape

SL-SMT 5.08HC/90 Box



High-temperature-resistant, 90° angled, open male header. Packed in box or tape. On tape, with 1.5 mm solder pin, optimised for automatic assembly. 3.2 mm solder pin suitable for reflow and wave soldering. The pin headers provide space for labelling and can be coded. HC = High Current.

General ordering data

Type	SL-SMT 5.08HC/03/90 3.2...	Version
Order No.	1779960000	PCB plug-in connector, male header, open side, THT/THR solder
GTIN (EAN)	4032248165285	connection, 5.08 mm, Number of poles: 3, 90°, Solder pin length (l):
Qty.	100 ST	3.2 mm, tinned, black, Box

BLL 5.08/03/90 4.5 SN OR BX

Weidmüller Interface GmbH & Co. KG
 Klingenbergstraße 26
 D-32758 Detmold
 Germany

www.weidmueller.com

Counterpart

SL-SMT 5.08HC/90 Tape



High-temperature-resistant, 90° angled, open male header. Packed in box or tape. On tape, with 1.5 mm solder pin, optimised for automatic assembly. 3.2 mm solder pin suitable for reflow and wave soldering. The pin headers provide space for labelling and can be coded. HC = High Current.

General ordering data

Type	SL-SMT 5.08HC/03/90 1.5...	Version	
Order No.	1821170000	PCB plug-in connector, male header, open side, THT/THR solder connection, 5.08 mm, Number of poles: 3, 90°, Solder pin length (l):	
GTIN (EAN)	4032248319817		
Qty.	350 ST	1.5 mm, tinned, black, Tape	

SL-SMT 5.08/180 Tape

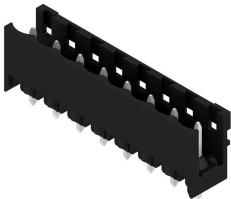

High-temperature-resistant, straight, open pin header. Packed in box or tape. On tape and with 1.5 mm solder pin, optimised for automatic assembly. 3.2 mm solder pin suitable for reflow and wave soldering. The pin headers provide space for labelling and can be coded. HC = High Current.

General ordering data

Type	SL-SMT 5.08HC/03/180 1....	Version	
Order No.	1821110000	PCB plug-in connector, male header, open side, THT/THR solder connection, 5.08 mm, Number of poles: 3, 180°, Solder pin length (l):	
GTIN (EAN)	4032248319756		
Qty.	250 ST	1.5 mm, tinned, black, Tape	