

## BL 3.50/07/270F SN OR BX

**Weidmüller Interface GmbH & Co. KG**  
 Klingenbergstraße 26  
 D-32758 Detmold  
 Germany

www.weidmueller.com

### Product image

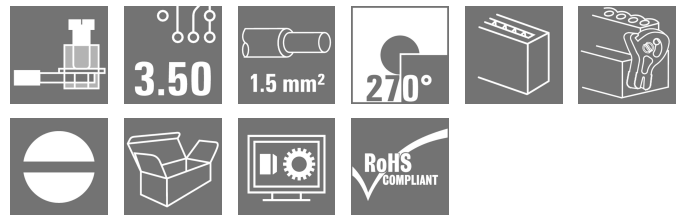

Female connectors with clamping yoke screw system for connecting conductors at 3.50 mm pitch. They provide space for labelling and can be coded.

### General ordering data

Version	PCB plug-in connector, female plug, 3.50 mm, Number of poles: 7, 270°, Clamping yoke connection, Clamping range, max. : 1.5 mm², Box
Order No.	<a href="#">1639980000</a>
Type	BL 3.50/07/270F SN OR BX
GTIN (EAN)	4008190277536
Qty.	60 items
Product data	IEC: 320 V / 12 A / 0.2 - 1.5 mm² UL: 300 V / 8 A / AWG 28 - AWG 14
Packaging	Box

## BL 3.50/07/270F SN OR BX

**Weidmüller Interface GmbH & Co. KG**  
 Klingenbergstraße 26  
 D-32758 Detmold  
 Germany

www.weidmueller.com

## Technical data

### Approvals

Approvals



ROHS	Conform
UL File Number Search	<a href="#">UL Website</a>
Certificate No. (UR)	E60693

### Dimensions and weights

Depth	22.45 mm	Depth (inches)	0.8839 inch
Height	12 mm	Height (inches)	0.4724 inch
Width	31.5 mm	Width (inches)	1.2402 inch
Net weight	6.47 g		

### Environmental Product Compliance

RoHS Compliance Status	Compliant without exemption		
REACH SVHC	No SVHC above 0.1 wt%		
Product Carbon Footprint	Cradle to gate	0,381 kg CO2 eq.	

### System Parameters

Product family	OMNIMATE Signal - series BL/SL 3.50		
Type of connection	Field connection		
Wire connection method	Clamping yoke connection		
Pitch in mm (P)	3.50 mm		
Pitch in inches (P)	0.138 "		
Conductor outlet direction	270°		
Number of poles	7		
L1 in mm	21.00 mm		
L1 in inches	0.827 "		
Number of rows	1		
Pin series quantity	1		
Rated cross-section	1.5 mm <sup>2</sup>		
Touch-safe protection acc. to DIN VDE 57 106	Safe from finger touch		
Touch-safe protection acc. to DIN VDE 0470	IP20 plugged/ IP10 unplugged		
Protection degree	IP20, when fully mounted		
Volume resistance	≤5 mΩ		
Can be coded	Yes		
Stripping length	6 mm		
Clamping screw	M 2		
Screwdriver blade	0.4 x 2.5		
Screwdriver blade standard	DIN 5264		
Plugging cycles	25		
Plugging force/pole, max.	7 N		
Pulling force/pole, max.	5 N		
Tightening torque	Torque type		Wire connection
	Usage information		Tightening torque
			min. 0.2 Nm
	Usage information		max. 0.25 Nm
Torque type			Screw flange
Usage information		Tightening torque	
		min. 0.15 Nm	
Usage information		max. 0.2 Nm	

## BL 3.50/07/270F SN OR BX

**Weidmüller Interface GmbH & Co. KG**  
 Klingenbergstraße 26  
 D-32758 Detmold  
 Germany

www.weidmueller.com

## Technical data

### Material data

Insulating material	PBT	Colour	orange
Colour chart (similar)	RAL 2000	Insulating material group	Illa
Comparative Tracking Index (CTI)	≥ 200	Insulation resistance	≥ 108 Ω
Moisture Level (MSL)		UL 94 flammability rating	V-0
Contact material	Cu-alloy	Contact surface	tinned
Layer structure of plug contact	4...8 μm Sn hot-dip tinned	Storage temperature, min.	-40 °C
Storage temperature, max.	70 °C	Operating temperature, min.	-50 °C
Operating temperature, max.	100 °C	Temperature range, installation, min.	-30 °C
Temperature range, installation, max.	100 °C		

### Conductors suitable for connection

Clamping range, min.	0.08 mm <sup>2</sup>
Clamping range, max.	1.5 mm <sup>2</sup>
Wire connection cross section AWG, min.	AWG 28
Wire connection cross section AWG, max.	AWG 14
Solid, min. H05(07) V-U	0.2 mm <sup>2</sup>
Solid, max. H05(07) V-U	1.5 mm <sup>2</sup>
Flexible, min. H05(07) V-K	0.2 mm <sup>2</sup>
Flexible, max. H05(07) V-K	1.5 mm <sup>2</sup>
w. plastic collar ferrule, DIN 46228 pt 4, 0.2 mm <sup>2</sup> min.	
w. plastic collar ferrule, DIN 46228 pt 4, 1.5 mm <sup>2</sup> max.	
w. wire end ferrule, DIN 46228 pt 1, min.	0.2 mm <sup>2</sup>
w. wire end ferrule, DIN 46228 pt 1, max.	1.5 mm <sup>2</sup>
Plug gauge in accordance with EN 60999 a x b; ø	2.4 mm x 1.5 mm

Clampable conductor	Cross-section for conductor connection	Type	fine-wired
		nominal	0.5 mm <sup>2</sup>
wire end ferrule	wire end ferrule	Stripping length	nominal 8 mm
		Recommended wire-end ferrule	<a href="#">H0.5/12 OR</a>
		Stripping length	nominal 6 mm
		Recommended wire-end ferrule	<a href="#">H0.5/6</a>
Cross-section for conductor connection	wire end ferrule	Type	fine-wired
		nominal	0.75 mm <sup>2</sup>
		Stripping length	nominal 8 mm
		Recommended wire-end ferrule	<a href="#">H0.75/12 W</a>
Cross-section for conductor connection	wire end ferrule	Stripping length	nominal 6 mm
		Recommended wire-end ferrule	<a href="#">H0.75/6</a>
		Type	fine-wired
		nominal	1 mm <sup>2</sup>
Cross-section for conductor connection	wire end ferrule	Stripping length	nominal 8 mm
		Recommended wire-end ferrule	<a href="#">H1.0/12 GE</a>
		Stripping length	nominal 6 mm
		Recommended wire-end ferrule	<a href="#">H1.0/6</a>
Cross-section for conductor connection	wire end ferrule	Type	fine-wired
		nominal	0.25 mm <sup>2</sup>

**BL 3.50/07/270F SN OR BX**

**Weidmüller Interface GmbH & Co. KG**  
 Klingenbergstraße 26  
 D-32758 Detmold  
 Germany

www.weidmueller.com

**Technical data**

wire end ferrule	Stripping length	nominal	8 mm
	Recommended wire-end ferrule	<a href="#">H0,25/10 HBL</a>	
Cross-section for conductor connection	Stripping length	nominal	5 mm
	Recommended wire-end ferrule	<a href="#">H0,25/5</a>	
wire end ferrule	Type	fine-wired	
	nominal	0.34 mm <sup>2</sup>	
wire end ferrule	Stripping length	nominal	8 mm
	Recommended wire-end ferrule	<a href="#">H0,34/10 TK</a>	

Reference text The outside diameter of the plastic collar should not be larger than the pitch (P), Length of ferrules is to be chosen depending on the product and the rated voltage.

**Rated data acc. to IEC**

tested acc. to standard	IEC 60664-1, IEC 61984	Rated current, min. number of poles (Tu=20°C)	12 A
Rated current, max. number of poles (Tu=20°C)	10 A	Rated current, min. number of poles (Tu=40°C)	10 A
Rated current, max. number of poles (Tu=40°C)	8 A	Rated voltage for surge voltage class / pollution degree II/2	320 V
Rated voltage for surge voltage class / pollution degree III/2	160 V	Rated voltage for surge voltage class / pollution degree III/3	160 V
Rated impulse voltage for surge voltage class/ pollution degree II/2	2.5 kV	Rated impulse voltage for surge voltage class/ pollution degree III/2	2.5 kV
Rated impulse voltage for surge voltage class/ contamination degree III/3	2.5 kV	Short-time withstand current resistance	3 x 1s with 100 A

**Rated data acc. to CSA**

Institute (CSA)	CSA	Certificate No. (CSA)	154685-1318353
Rated voltage (Use group B / CSA)	300 V	Rated voltage (Use group D / CSA)	300 V
Rated current (Use group B / CSA)	10 A	Rated current (Use group D / CSA)	10 A
Wire cross-section, AWG, min.	AWG 28	Wire cross-section, AWG, max.	AWG 14
Reference to approval values	Specifications are maximum values, details - see approval certificate.		

**Rated data acc. to UL 1059**

Institute (UR)	UR	Certificate No. (UR)	E60693
Rated voltage (Use group B / UL 1059)	300 V	Rated voltage (Use group D / UL 1059)	300 V
Rated current (Use group B / UL 1059)	8 A	Rated current (Use group D / UL 1059)	8 A
Wire cross-section, AWG, min.	AWG 28	Wire cross-section, AWG, max.	AWG 14
Reference to approval values	Specifications are maximum values, details - see approval certificate.		

**Packing**

Packaging	Box	VPE length	348.00 mm
VPE width	134.00 mm	VPE height	30.00 mm

**Type tests**

Test: Durability of markings	Standard	DIN EN 61984 section 7.3.2 / 09.02 taking pattern from DIN EN 60068-2-70 / 07.96
	Test	mark of origin, type identification, approval marking SEV, approval marking CSA

**Technical data**

	Evaluation	available
	Test	durability
	Evaluation	passed
Test: Misengagement (Non-interchangeability)	Standard	DIN EN 61984 section 6.3 and 6.9.1 / 09.02, DIN IEC 60512 part 7 section 5 / 05.94
	Test	180° turned with coding elements
	Evaluation	passed
Test: Clampable cross section	Standard	DIN EN 60999-1 section 7 and 9.1 / 12.00, DIN EN 60947-1 section 8.2.4.5.1 / 12.99
	Conductor type	Type of conductor and conductor cross-section solid 0.2 mm <sup>2</sup>
		Type of conductor and conductor cross-section stranded 0.2 mm <sup>2</sup>
		Type of conductor and conductor cross-section solid 1.5 mm <sup>2</sup>
		Type of conductor and conductor cross-section stranded 1.5 mm <sup>2</sup>
		Type of conductor and conductor cross-section AWG 28/1
		Type of conductor and conductor cross-section AWG 28/19
		Type of conductor and conductor cross-section AWG 16/1
		Type of conductor and conductor cross-section AWG 16/19
	Evaluation	passed
Test for damage to and accidental loosening of conductors	Standard	DIN EN 60999-1 section 9.4 / 12.00
	Requirement	0.2 kg
	Conductor type	Type of conductor and conductor cross-section AWG 28/1
		Type of conductor and conductor cross-section AWG 28/19
	Evaluation	passed
	Requirement	0.3 kg
	Conductor type	Type of conductor and conductor cross-section 2 × AWG 24/1
		Type of conductor and conductor cross-section 2 × AWG 24/19 with wire end ferrule
	Evaluation	passed
	Requirement	0.4 kg
	Conductor type	Type of conductor and conductor cross-section solid 1.5 mm <sup>2</sup>
		Type of conductor and conductor cross-section stranded 1.5 mm <sup>2</sup>
		Type of conductor and conductor cross-section AWG 16/7
	Evaluation	passed
Pull-out test	Standard	DIN EN 60999-1 section 9.5 / 12.00

### Technical data

Requirement		≥5 N	
Conductor type	Type of conductor and conductor cross-section	AWG 28/1	
	Type of conductor and conductor cross-section	AWG 28/19	
Evaluation		passed	
Requirement		≥10 N	
Conductor type	Type of conductor and conductor cross-section	2 × AWG 24/1	
	Type of conductor and conductor cross-section	2 × AWG 24/19 with wire end ferrule	
Evaluation		passed	
Requirement		≥40 N	
Conductor type	Type of conductor and conductor cross-section	H05V-U1.5	
	Type of conductor and conductor cross-section	H05V-K1.5	
	Type of conductor and conductor cross-section	AWG 16/7	
Evaluation		passed	

### Important note

**IPC conformity** Conformity: The products are developed, manufactured and delivered according international recognized standards and norms and comply with the assured properties in the data sheet resp. fulfill decorative properties in accordance with IPC-A-610 "Class 2". Further claims on the products can be evaluated on request.

- Notes**
- Additional variants on request
  - Gold-plated contact surfaces on request
  - Max. outer diameter of the conductor: 2.9 mm
  - Max. outer diameter of the conductor: 2.9 mm
  - Wire end ferrule without plastic collar to DIN 46228/1
  - Wire end ferrule with plastic collar to DIN 46228/4
  - P on drawing = pitch
  - Rated data refer only to the component itself. Clearance and creepage distances to other components are to be designed in accordance with the relevant application standards.
  - In accordance with IEC 61984, OMNIMATE-connectors are connectors without breaking capacity (COC). During designated use, connectors are not allowed to be engaged or disengaged when live or under load
  - Long term storage of the product with average temperature of 50 °C and maximum humidity 70%, 36 months

### Classifications

ETIM 6.0	EC002638	ETIM 7.0	EC002638
ETIM 8.0	EC002638	ETIM 9.0	EC002638
ETIM 10.0	EC002638	ECLASS 9.0	27-44-03-09
ECLASS 9.1	27-44-03-09	ECLASS 10.0	27-44-03-09
ECLASS 11.0	27-46-02-02	ECLASS 12.0	27-46-02-02
ECLASS 13.0	27-46-02-02	ECLASS 14.0	27-46-02-02
ECLASS 15.0	27-46-02-02		

Product image

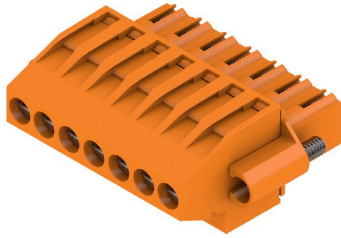

Dimensional drawing

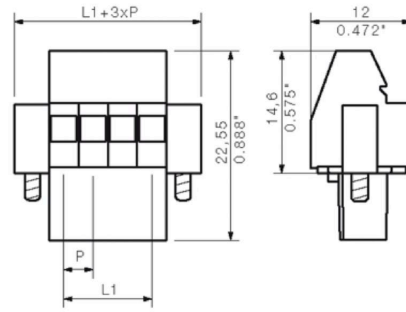

Graph

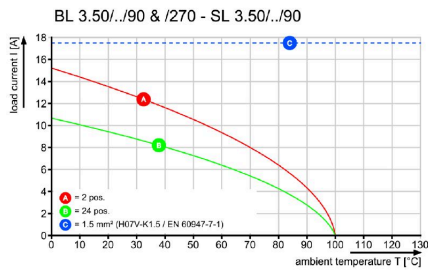

Graph

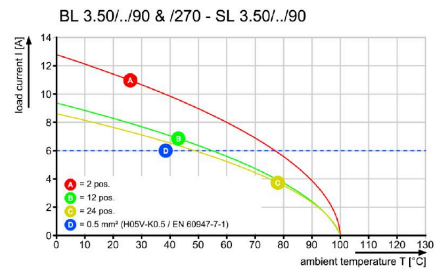

**Accessories**

**Coding elements**



Only connects what is supposed to be connected: the right connection at the right place.  
 Coding elements and locking devices clearly assign connecting elements during the manufacturing process and operation  
 The coding elements and locking devices are inserted prior to assembly or during the cable assembly phase. The Weidmüller alternative: configure online using the variant configurator to precode prior to delivery. Incorrect assembly on the circuit board and incorrect plugging of connecting elements is no longer possible. The advantage: no troubleshooting during manufacture and no operational errors by the user.

**General ordering data**

Type	BL SL 3.5 KO OR	Version
Order No.	<a href="#">1693430000</a>	PCB plug-in connector, Accessories, Coding element, orange, Number
GTIN (EAN)	4008190867447	of poles: 1
Qty.	100 ST	
Type	BL SL 3.5 KO SW	Version
Order No.	<a href="#">1610100000</a>	PCB plug-in connector, Accessories, Coding element, black, Number
GTIN (EAN)	4008190187637	of poles: 1
Qty.	100 ST	



## BL 3.50/07/270F SN OR BX

**Weidmüller Interface GmbH & Co. KG**  
 Klingenbergstraße 26  
 D-32758 Detmold  
 Germany

www.weidmueller.com

## Counterpart

## SLD 3.50/90

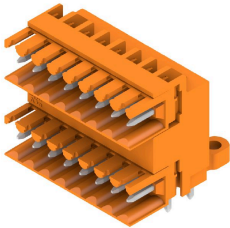

Two-tier pin header for wave soldering in 3.50 mm pitch. The connector is available in open, closed and flange versions. The male connectors provide space for labelling and can be coded. Packed in a cardboard box.

## General ordering data

Type	SLD 3.50/14/90 3.2SN OR...	Version
Order No.	<a href="#">1633400000</a>	PCB plug-in connector, male header, open side, THT solder
GTIN (EAN)	4008190257859	connection, 3.50 mm, Number of poles: 14, 90°, Solder pin length (l):
Qty.	20 ST	3.2 mm, tinned, orange, Box

## SLD 3.50/90G

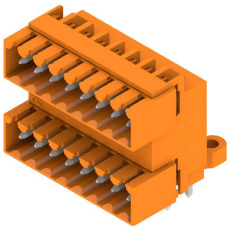

Two-tier pin header for wave soldering in 3.50 mm pitch. The connector is available in open, closed and flange versions. The male connectors provide space for labelling and can be coded. Packed in a cardboard box.

## General ordering data

Type	SLD 3.50/14/90G 3.2SN O...	Version
Order No.	<a href="#">1633630000</a>	PCB plug-in connector, male header, closed side, THT solder
GTIN (EAN)	4008190258085	connection, 3.50 mm, Number of poles: 14, 90°, Solder pin length (l):
Qty.	20 ST	3.2 mm, tinned, orange, Box

## SL-SMT 3.5/180G Box

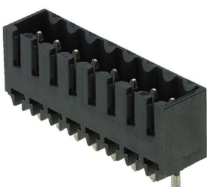

High-temperature-resistant male header, 3.50 mm pitch.

- Plugging direction parallel (90°), straight 180° or angled (135°) to PCB
- Housing variants: closed side (G), screw flange (F), solder flange (LF) or snap-on solder flange (RF)
- Optimised for the SMT process
- Pin length 3.2 mm universal for all soldering methods
- Pin length 1.5 mm optimised for reflow soldering methods
- Packed either in a box (BX) or tape-on-reel (RL)
- Male header can be coded

## BL 3.50/07/270F SN OR BX

**Weidmüller Interface GmbH & Co. KG**  
 Klingenbergstraße 26  
 D-32758 Detmold  
 Germany

## Counterpart

www.weidmueller.com

## General ordering data

Type	SL-SMT 3.50/07/180G 1.5...	Version
Order No.	<a href="#">1753032001</a>	PCB plug-in connector, male header, closed side, THT/THR solder
GTIN (EAN)	4032248130931	connection, 3.50 mm, Number of poles: 7, 180°, Solder pin length (l):
Qty.	50 ST	1.5 mm, tinned, black, Box

## SL-SMT 3.5/180G Tape

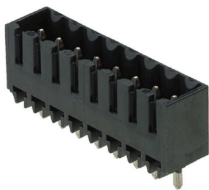

- High-temperature-resistant male header, 3.50 mm pitch.
- Plugging direction parallel (90°), straight 180° or angled (135°) to PCB
  - Housing variants: closed side (G), screw flange (F), solder flange (LF) or snap-on solder flange (RF)
  - Optimised for the SMT process
  - Pin length 3.2 mm universal for all soldering methods
  - Pin length 1.5 mm optimised for reflow soldering methods
  - Packed either in a box (BX) or tape-on-reel (RL)
  - Male header can be coded

## General ordering data

Type	SL-SMT 3.50/07/180G 1.5...	Version
Order No.	<a href="#">1753034001</a>	PCB plug-in connector, male header, closed side, THT/THR solder
GTIN (EAN)	4032248135639	connection, 3.50 mm, Number of poles: 7, 180°, Solder pin length (l):
Qty.	265 ST	1.5 mm, tinned, black, Tape

## SL-SMT 3.5/90G Tray

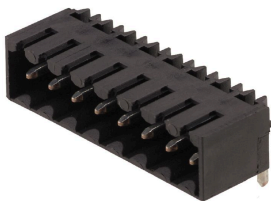

- High-temperature-resistant male header, 3.50 mm pitch.
- Plugging direction parallel (90°), straight 180° or angled (135°) to PCB
  - Housing variants: closed side (G), screw flange (F), solder flange (LF) or snap-on solder flange (RF)
  - Optimised for the SMT process
  - Pin length 3.2 mm universal for all soldering methods
  - Pin length 1.5 mm optimised for reflow soldering methods
  - Packed either in a box (BX) or tape-on-reel (RL)
  - Male header can be coded

## General ordering data

Type	SL-SMT 3.50/07/90G 1.5S...	Version
Order No.	<a href="#">1761593001</a>	PCB plug-in connector, male header, closed side, THT/THR solder
GTIN (EAN)	4032248133864	connection, 3.50 mm, Number of poles: 7, 90°, Solder pin length (l):
Qty.	60 ST	1.5 mm, tinned, black, Tray

## BL 3.50/07/270F SN OR BX

**Weidmüller Interface GmbH & Co. KG**  
 Klingenbergstraße 26  
 D-32758 Detmold  
 Germany

www.weidmueller.com

## Counterpart

## SL-SMT 3.5/90G Tape

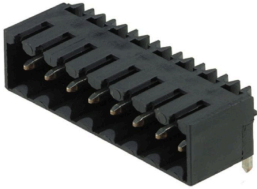

- High-temperature-resistant male header, 3.50 mm pitch.
- Plugging direction parallel (90°), straight 180° or angled (135°) to PCB
  - Housing variants: closed side (G), screw flange (F), solder flange (LF) or snap-on solder flange (RF)
  - Optimised for the SMT process
  - Pin length 3.2 mm universal for all soldering methods
  - Pin length 1.5 mm optimised for reflow soldering methods
  - Packed either in a box (BX) or tape-on-reel (RL)
  - Male header can be coded

## General ordering data

Type	SL-SMT 3.50/07/90G 1.5S...	Version
Order No.	<a href="#">1761594001</a>	PCB plug-in connector, male header, closed side, THT/THR solder
GTIN (EAN)	4032248136032	connection, 3.50 mm, Number of poles: 7, 90°, Solder pin length (l):
Qty.	385 ST	1.5 mm, tinned, black, Tape

## SL 3.50/90

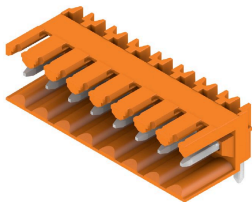

- Pin headers for wave soldering in 3.50 mm pitch
- Plugging direction is parallel (90°), straight 180° or angled (135°) to the PCB
  - Housing variant: screw flange (F)
  - Packed in a cardboard box (BX)
  - Pin header can be coded

## General ordering data

Type	SL 3.50/07/90 3.2SN OR ...	Version
Order No.	<a href="#">1597260000</a>	PCB plug-in connector, male header, open side, THT solder
GTIN (EAN)	4008190044350	connection, 3.50 mm, Number of poles: 7, 90°, Solder pin length (l):
Qty.	50 ST	3.2 mm, tinned, orange, Box

## SL 3.50/180G

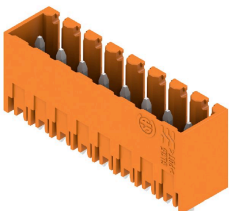

- Pin headers for wave soldering in 3.50 mm pitch
- Plugging direction is parallel (90°), straight 180° or angled (135°) to the PCB
  - Housing variant: screw flange (F)
  - Packed in a cardboard box (BX)
  - Pin header can be coded

## BL 3.50/07/270F SN OR BX

**Weidmüller Interface GmbH & Co. KG**  
 Klingenbergstraße 26  
 D-32758 Detmold  
 Germany

www.weidmueller.com

## Counterpart

## General ordering data

Type	SL 3.50/07/180G 3.2SN O...	Version
Order No.	<a href="#">1604520000</a>	PCB plug-in connector, male header, closed side, THT solder
GTIN (EAN)	4008190178727	connection, 3.50 mm, Number of poles: 7, 180°, Solder pin length (l):
Qty.	50 ST	3.2 mm, tinned, orange, Box

## SL 3.50/180

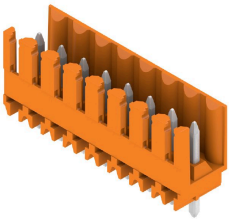

- Pin headers for wave soldering in 3.50 mm pitch
- Plugging direction is parallel (90°), straight 180° or angled (135°) to the PCB
  - Housing variant: screw flange (F)
  - Packed in a cardboard box (BX)
  - Pin header can be coded

## General ordering data

Type	SL 3.50/07/180 3.2SN OR...	Version
Order No.	<a href="#">1604820000</a>	PCB plug-in connector, male header, open side, THT solder
GTIN (EAN)	4008190176129	connection, 3.50 mm, Number of poles: 7, 180°, Solder pin length (l):
Qty.	50 ST	3.2 mm, tinned, orange, Box

## SL 3.50/90G

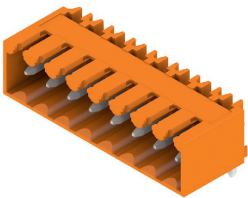

- Pin headers for wave soldering in 3.50 mm pitch
- Plugging direction is parallel (90°), straight 180° or angled (135°) to the PCB
  - Housing variant: screw flange (F)
  - Packed in a cardboard box (BX)
  - Pin header can be coded

## General ordering data

Type	SL 3.50/07/90G 3.2SN OR...	Version
Order No.	<a href="#">1605120000</a>	PCB plug-in connector, male header, closed side, THT solder
GTIN (EAN)	4008190169954	connection, 3.50 mm, Number of poles: 7, 90°, Solder pin length (l):
Qty.	50 ST	3.2 mm, tinned, orange, Box
Type	SL 3.50/07/90G 4.5SN BK...	Version
Order No.	<a href="#">1615450000</a>	PCB plug-in connector, male header, closed side, THT solder
GTIN (EAN)	4008190055578	connection, 3.50 mm, Number of poles: 7, 90°, Solder pin length (l):
Qty.	50 ST	4.5 mm, tinned, black, Box

## BL 3.50/07/270F SN OR BX

**Weidmüller Interface GmbH & Co. KG**  
 Klingenbergstraße 26  
 D-32758 Detmold  
 Germany

www.weidmueller.com

## Counterpart

## SL 3.50/180G

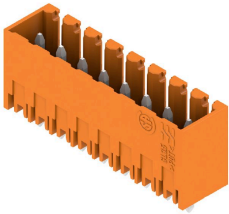

- Pin headers for wave soldering in 3.50 mm pitch
- Plugging direction is parallel (90°), straight 180° or angled (135°) to the PCB
  - Housing variant: screw flange (F)
  - Packed in a cardboard box (BX)
  - Pin header can be coded

## General ordering data

Type	SL 3.50/07/180G 4.5SN B...	Version
Order No.	<a href="#">1616060000</a>	PCB plug-in connector, male header, closed side, THT solder
GTIN (EAN)	4008190065942	connection, 3.50 mm, Number of poles: 7, 180°, Solder pin length (l):
Qty.	50 ST	4.5 mm, tinned, black, Box

## SL-SMT 3.5/180G Box

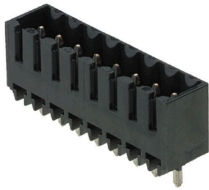

- High-temperature-resistant male header, 3.50 mm pitch.
- Plugging direction parallel (90°), straight 180° or angled (135°) to PCB
  - Housing variants: closed side (G), screw flange (F), solder flange (LF) or snap-on solder flange (RF)
  - Optimised for the SMT process
  - Pin length 3.2 mm universal for all soldering methods
  - Pin length 1.5 mm optimised for reflow soldering methods
  - Packed either in a box (BX) or tape-on-reel (RL)
  - Male header can be coded

## General ordering data

Type	SL-SMT 3.50/07/180G 3.2...	Version
Order No.	<a href="#">1842370000</a>	PCB plug-in connector, male header, closed side, THT/THR solder
GTIN (EAN)	4032248353729	connection, 3.50 mm, Number of poles: 7, 180°, Solder pin length (l):
Qty.	50 ST	3.2 mm, tinned, black, Box

## SL-SMT 3.5/90G Box

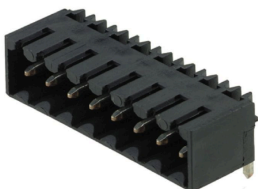

- High-temperature-resistant male header, 3.50 mm pitch.
- Plugging direction parallel (90°), straight 180° or angled (135°) to PCB
  - Housing variants: closed side (G), screw flange (F), solder flange (LF) or snap-on solder flange (RF)
  - Optimised for the SMT process
  - Pin length 3.2 mm universal for all soldering methods
  - Pin length 1.5 mm optimised for reflow soldering methods
  - Packed either in a box (BX) or tape-on-reel (RL)
  - Male header can be coded

## BL 3.50/07/270F SN OR BX

**Weidmüller Interface GmbH & Co. KG**  
 Klingenbergstraße 26  
 D-32758 Detmold  
 Germany

www.weidmueller.com

## Counterpart

## General ordering data

Type	SL-SMT 3.50/07/90G 3.2S...	Version
Order No.	<a href="#">1841680000</a>	PCB plug-in connector, male header, closed side, THT/THR solder
GTIN (EAN)	4032248353033	connection, 3.50 mm, Number of poles: 7, 90°, Solder pin length (l):
Qty.	50 ST	3.2 mm, tinned, black, Box

## SL-THR 3.5/135F



- High-temperature-resistant male header, 3.50 mm pitch.
- Plugging direction parallel (90°), straight 180° or angled (135°) to PCB
  - Housing variants: closed side (G), screw flange (F), solder flange (LF) or snap-on solder flange (RF)
  - Optimised for the SMT process
  - Pin length 3.2 mm universal for all soldering methods
  - Pin length 1.5 mm optimised for reflow soldering methods
  - Packed either in a box (BX) or tape-on-reel (RL)
  - Male header can be coded

## General ordering data

Type	SL-SMT 3.50/07/135F 3.2...	Version
Order No.	<a href="#">1003560000</a>	PCB plug-in connector, male header, Flange, THT/THR solder
GTIN (EAN)	4032248700189	connection, 3.50 mm, Number of poles: 7, 135°, Solder pin length (l):
Qty.	54 ST	3.2 mm, tinned, black, Box

## SLD 3.50/90F

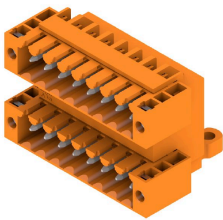

Two-tier pin header for wave soldering in 3.50 mm pitch. The connector is available in open, closed and flange versions. The male connectors provide space for labelling and can be coded. Packed in a cardboard box.

## General ordering data

Type	SLD 3.50/14/90F 3.2SN O...	Version
Order No.	<a href="#">1633860000</a>	PCB plug-in connector, male header, Flange, THT solder connection,
GTIN (EAN)	4008190258313	3.50 mm, Number of poles: 14, 90°, Solder pin length (l): 3.2 mm,
Qty.	20 ST	tinned, orange, Box

## BL 3.50/07/270F SN OR BX

**Weidmüller Interface GmbH & Co. KG**  
 Klingenbergstraße 26  
 D-32758 Detmold  
 Germany

## Counterpart

www.weidmueller.com

## SL 3.50/135F

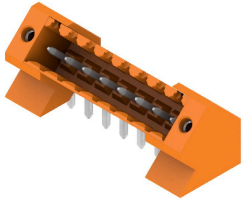

- Pin headers for wave soldering in 3.50 mm pitch
- Plugging direction is parallel (90°), straight 180° or angled (135°) to the PCB
  - Housing variant: screw flange (F)
  - Packed in a cardboard box (BX)
  - Pin header can be coded

## General ordering data

Type	SL 3.50/07/135F 3.2SN O...	Version
Order No.	<a href="#">1643380000</a>	PCB plug-in connector, male header, Flange, THT solder connection,
GTIN (EAN)	4008190282141	3.50 mm, Number of poles: 7, 135°, Solder pin length (l): 3.2 mm,
Qty.	54 ST	tinned, orange, Box

## SL 3.50/90F

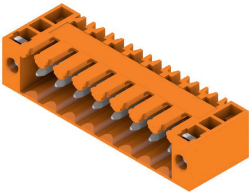

- Pin headers for wave soldering in 3.50 mm pitch
- Plugging direction is parallel (90°), straight 180° or angled (135°) to the PCB
  - Housing variant: screw flange (F)
  - Packed in a cardboard box (BX)
  - Pin header can be coded

## General ordering data

Type	SL 3.50/07/90F 3.2SN OR...	Version
Order No.	<a href="#">1607090000</a>	PCB plug-in connector, male header, Flange, THT solder connection,
GTIN (EAN)	4008190184216	3.50 mm, Number of poles: 7, 90°, Solder pin length (l): 3.2 mm,
Qty.	50 ST	tinned, orange, Box

## SL 3.50/180F

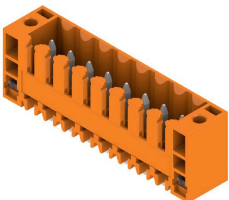

- Pin headers for wave soldering in 3.50 mm pitch
- Plugging direction is parallel (90°), straight 180° or angled (135°) to the PCB
  - Housing variant: screw flange (F)
  - Packed in a cardboard box (BX)
  - Pin header can be coded

## General ordering data

Type	SL 3.50/07/180F 3.2SN O...	Version
Order No.	<a href="#">1607550000</a>	PCB plug-in connector, male header, Flange, THT solder connection,
GTIN (EAN)	4008190060343	3.50 mm, Number of poles: 7, 180°, Solder pin length (l): 3.2 mm,
Qty.	50 ST	tinned, orange, Box

## BL 3.50/07/270F SN OR BX

**Weidmüller Interface GmbH & Co. KG**  
 Klingenbergstraße 26  
 D-32758 Detmold  
 Germany

www.weidmueller.com

## Counterpart

## SL 3.50/90F

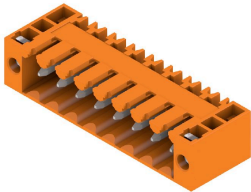

Pin headers for wave soldering in 3.50 mm pitch

- Plugging direction is parallel (90°), straight 180° or angled (135°) to the PCB
- Housing variant: screw flange (F)
- Packed in a cardboard box (BX)
- Pin header can be coded

## General ordering data

Type	SL 3.50/07/90F 4.5SN BK...	Version
Order No.	<a href="#">1615580000</a>	PCB plug-in connector, male header, Flange, THT solder connection,
GTIN (EAN)	4008190057510	3.50 mm, Number of poles: 7, 90°, Solder pin length (l): 4.5 mm,
Qty.	50 ST	tinned, black, Box

## SL-SMT 3.5/90LF Tape

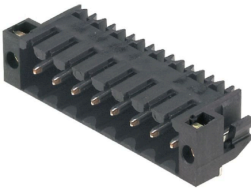

High-temperature-resistant male header, 3.50 mm pitch.

- Plugging direction parallel (90°), straight 180° or angled (135°) to PCB
- Housing variants: closed side (G), screw flange (F), solder flange (LF) or snap-on solder flange (RF)
- Optimised for the SMT process
- Pin length 3.2 mm universal for all soldering methods
- Pin length 1.5 mm optimised for reflow soldering methods
- Packed either in a box (BX) or tape-on-reel (RL)
- Male header can be coded

## General ordering data

Type	SL-SMT 3.50/07/90LF 1.5...	Version
Order No.	<a href="#">1805360000</a>	PCB plug-in connector, male header, Solder flange, THT/THR solder
GTIN (EAN)	4032248269716	connection, 3.50 mm, Number of poles: 7, 90°, Solder pin length (l):
Qty.	385 ST	1.5 mm, tinned, black, Tape

## SL-SMT 3.5/90LF Box

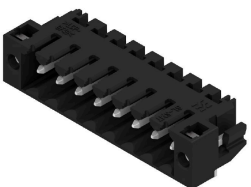

High-temperature-resistant male header, 3.50 mm pitch.

- Plugging direction parallel (90°), straight 180° or angled (135°) to PCB
- Housing variants: closed side (G), screw flange (F), solder flange (LF) or snap-on solder flange (RF)
- Optimised for the SMT process
- Pin length 3.2 mm universal for all soldering methods
- Pin length 1.5 mm optimised for reflow soldering methods
- Packed either in a box (BX) or tape-on-reel (RL)
- Male header can be coded



## BL 3.50/07/270F SN OR BX

**Weidmüller Interface GmbH & Co. KG**  
 Klingenbergstraße 26  
 D-32758 Detmold  
 Germany

## Counterpart

www.weidmueller.com

## General ordering data

Type	SL-SMT 3.50/07/90LF 1.5...	Version
Order No.	<a href="#">1804990000</a>	PCB plug-in connector, male header, Solder flange, THT/THR solder
GTIN (EAN)	4032248268894	connection, 3.50 mm, Number of poles: 7, 90°, Solder pin length (l):
Qty.	54 ST	1.5 mm, tinned, black, Box

## SL-SMT 3.5/180F Box



- High-temperature-resistant male header, 3.50 mm pitch.
- Plugging direction parallel (90°), straight 180° or angled (135°) to PCB
  - Housing variants: closed side (G), screw flange (F), solder flange (LF) or snap-on solder flange (RF)
  - Optimised for the SMT process
  - Pin length 3.2 mm universal for all soldering methods
  - Pin length 1.5 mm optimised for reflow soldering methods
  - Packed either in a box (BX) or tape-on-reel (RL)
  - Male header can be coded

## General ordering data

Type	SL-SMT 3.50/07/180F 3.2...	Version
Order No.	<a href="#">1842820000</a>	PCB plug-in connector, male header, Flange, THT/THR solder
GTIN (EAN)	4032248354184	connection, 3.50 mm, Number of poles: 7, 180°, Solder pin length (l):
Qty.	54 ST	3.2 mm, tinned, black, Box

## SL-SMT 3.5/180LF Tape

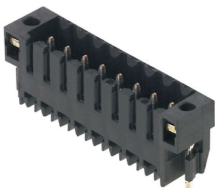

- High-temperature-resistant male header, 3.50 mm pitch.
- Plugging direction parallel (90°), straight 180° or angled (135°) to PCB
  - Housing variants: closed side (G), screw flange (F), solder flange (LF) or snap-on solder flange (RF)
  - Optimised for the SMT process
  - Pin length 3.2 mm universal for all soldering methods
  - Pin length 1.5 mm optimised for reflow soldering methods
  - Packed either in a box (BX) or tape-on-reel (RL)
  - Male header can be coded

## General ordering data

Type	SL-SMT 3.50/07/180LF 1....	Version
Order No.	<a href="#">1805280000</a>	PCB plug-in connector, male header, Solder flange, THT/THR solder
GTIN (EAN)	4032248269549	connection, 3.50 mm, Number of poles: 7, 180°, Solder pin length (l):
Qty.	265 ST	1.5 mm, tinned, black, Tape

## BL 3.50/07/270F SN OR BX

**Weidmüller Interface GmbH & Co. KG**  
 Klingenbergstraße 26  
 D-32758 Detmold  
 Germany

www.weidmueller.com

## Counterpart

## SL-SMT 3.5/180LF Box

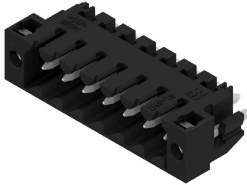

- High-temperature-resistant male header, 3.50 mm pitch.
- Plugging direction parallel (90°), straight 180° or angled (135°) to PCB
  - Housing variants: closed side (G), screw flange (F), solder flange (LF) or snap-on solder flange (RF)
  - Optimised for the SMT process
  - Pin length 3.2 mm universal for all soldering methods
  - Pin length 1.5 mm optimised for reflow soldering methods
  - Packed either in a box (BX) or tape-on-reel (RL)
  - Male header can be coded

## General ordering data

Type	SL-SMT 3.50/07/180LF 3...	Version
Order No.	<a href="#">1842590000</a>	PCB plug-in connector, male header, Solder flange, THT/THR solder
GTIN (EAN)	4032248353958	connection, 3.50 mm, Number of poles: 7, 180°, Solder pin length (l):
Qty.	54 ST	3.2 mm, tinned, black, Box

## SL-SMT 3.5/90LF Box

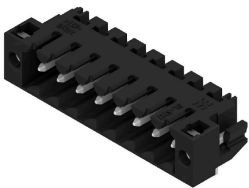

- High-temperature-resistant male header, 3.50 mm pitch.
- Plugging direction parallel (90°), straight 180° or angled (135°) to PCB
  - Housing variants: closed side (G), screw flange (F), solder flange (LF) or snap-on solder flange (RF)
  - Optimised for the SMT process
  - Pin length 3.2 mm universal for all soldering methods
  - Pin length 1.5 mm optimised for reflow soldering methods
  - Packed either in a box (BX) or tape-on-reel (RL)
  - Male header can be coded

## General ordering data

Type	SL-SMT 3.50/07/90LF 3.2...	Version
Order No.	<a href="#">1841910000</a>	PCB plug-in connector, male header, Solder flange, THT/THR solder
GTIN (EAN)	4032248353262	connection, 3.50 mm, Number of poles: 7, 90°, Solder pin length (l):
Qty.	54 ST	3.2 mm, tinned, black, Box

## SL-SMT 3.5/90F Box

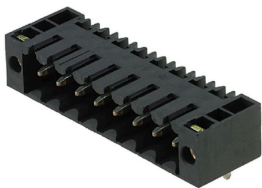

- High-temperature-resistant male header, 3.50 mm pitch.
- Plugging direction parallel (90°), straight 180° or angled (135°) to PCB
  - Housing variants: closed side (G), screw flange (F), solder flange (LF) or snap-on solder flange (RF)
  - Optimised for the SMT process
  - Pin length 3.2 mm universal for all soldering methods
  - Pin length 1.5 mm optimised for reflow soldering methods
  - Packed either in a box (BX) or tape-on-reel (RL)
  - Male header can be coded

**Counterpart****General ordering data**

Type	SL-SMT 3.50/07/90F 3.2S...	Version
Order No.	<a href="#">1842130000</a>	PCB plug-in connector, male header, Flange, THT/THR solder
GTIN (EAN)	4032248353484	connection, 3.50 mm, Number of poles: 7, 90°, Solder pin length (l):
Qty.	54 ST	3.2 mm, tinned, black, Box