

BL 3.50/02/270F SN OR BX

Weidmüller Interface GmbH & Co. KG
 Klingenbergstraße 26
 D-32758 Detmold
 Germany

www.weidmueller.com

Product image

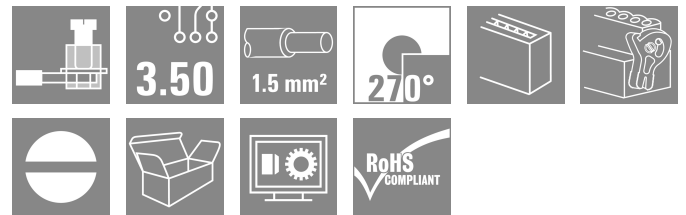
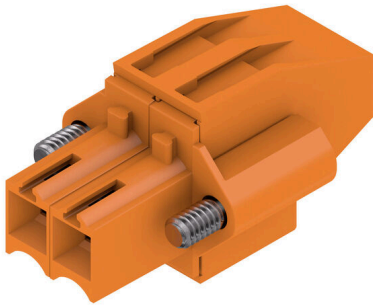

Female connectors with clamping yoke screw system for connecting conductors at 3.50 mm pitch. They provide space for labelling and can be coded.

General ordering data

Version	PCB plug-in connector, female plug, 3.50 mm, Number of poles: 2, 270°, Clamping yoke connection, Clamping range, max. : 1.5 mm², Box
Order No.	1639930000
Type	BL 3.50/02/270F SN OR BX
GTIN (EAN)	4008190277482
Qty.	132 items
Product data	IEC: 320 V / 12 A / 0.2 - 1.5 mm² UL: 300 V / 8 A / AWG 28 - AWG 14
Packaging	Box

BL 3.50/02/270F SN OR BX

Weidmüller Interface GmbH & Co. KG
 Klingenbergstraße 26
 D-32758 Detmold
 Germany

www.weidmueller.com

Technical data

Approvals

Approvals



ROHS	Conform
UL File Number Search	UL Website
Certificate No. (UR)	E60693

Dimensions and weights

Depth	22.45 mm	Depth (inches)	0.8839 inch
Height	12 mm	Height (inches)	0.4724 inch
Width	14 mm	Width (inches)	0.5512 inch
Net weight	2.57 g		

Environmental Product Compliance

RoHS Compliance Status	Compliant without exemption		
REACH SVHC	No SVHC above 0.1 wt%		
Product Carbon Footprint	Cradle to gate	0,225 kg CO2 eq.	

System Parameters

Product family	OMNIMATE Signal - series BL/SL 3.50			
Type of connection	Field connection			
Wire connection method	Clamping yoke connection			
Pitch in mm (P)	3.50 mm			
Pitch in inches (P)	0.138 "			
Conductor outlet direction	270°			
Number of poles	2			
L1 in mm	3.50 mm			
L1 in inches	0.138 "			
Number of rows	1			
Pin series quantity	1			
Rated cross-section	1.5 mm ²			
Touch-safe protection acc. to DIN VDE 57 106	Safe from finger touch			
Touch-safe protection acc. to DIN VDE 0470	IP20 plugged/ IP10 unplugged			
Protection degree	IP20, when fully mounted			
Volume resistance	≤5 mΩ			
Can be coded	Yes			
Stripping length	6 mm			
Clamping screw	M 2			
Screwdriver blade	0.4 x 2.5			
Screwdriver blade standard	DIN 5264			
Plugging cycles	25			
Plugging force/pole, max.	7 N			
Pulling force/pole, max.	5 N			
Tightening torque	Torque type	Wire connection		
		Usage information	Tightening torque	min. 0.2 Nm
	Torque type		Screw flange	
		Usage information	Tightening torque	min. 0.15 Nm

BL 3.50/02/270F SN OR BX

Weidmüller Interface GmbH & Co. KG
 Klingenbergstraße 26
 D-32758 Detmold
 Germany

www.weidmueller.com

Technical data

Material data

Insulating material	PBT	Colour	orange
Colour chart (similar)	RAL 2000	Insulating material group	Illa
Comparative Tracking Index (CTI)	≥ 200	Insulation resistance	≥ 108 Ω
Moisture Level (MSL)		UL 94 flammability rating	V-0
Contact material	Cu-alloy	Contact surface	tinned
Layer structure of plug contact	4...8 μm Sn hot-dip tinned	Storage temperature, min.	-40 °C
Storage temperature, max.	70 °C	Operating temperature, min.	-50 °C
Operating temperature, max.	100 °C	Temperature range, installation, min.	-30 °C
Temperature range, installation, max.	100 °C		

Conductors suitable for connection

Clamping range, min.	0.08 mm ²
Clamping range, max.	1.5 mm ²
Wire connection cross section AWG, min.	AWG 28
Wire connection cross section AWG, max.	AWG 14
Solid, min. H05(07) V-U	0.2 mm ²
Solid, max. H05(07) V-U	1.5 mm ²
Flexible, min. H05(07) V-K	0.2 mm ²
Flexible, max. H05(07) V-K	1.5 mm ²
w. plastic collar ferrule, DIN 46228 pt 4, min.	0.2 mm ²
w. plastic collar ferrule, DIN 46228 pt 4, max.	1.5 mm ²
w. wire end ferrule, DIN 46228 pt 1, min.	0.2 mm ²
w. wire end ferrule, DIN 46228 pt 1, max.	1.5 mm ²
Plug gauge in accordance with EN 60999 a x b; ø	2.4 mm x 1.5 mm

Clampable conductor	Cross-section for conductor connection	Type	fine-wired
			nominal
wire end ferrule		Stripping length	nominal 8 mm
		Recommended wire-end ferrule	H0.5/12 OR
		Stripping length	nominal 6 mm
		Recommended wire-end ferrule	H0.5/6
Cross-section for conductor connection	Type	fine-wired	
	nominal	0.75 mm ²	
wire end ferrule		Stripping length	nominal 8 mm
		Recommended wire-end ferrule	H0.75/12 W
		Stripping length	nominal 6 mm
		Recommended wire-end ferrule	H0.75/6
Cross-section for conductor connection	Type	fine-wired	
	nominal	1 mm ²	
wire end ferrule		Stripping length	nominal 8 mm
		Recommended wire-end ferrule	H1.0/12 GE
		Stripping length	nominal 6 mm
		Recommended wire-end ferrule	H1.0/6
Cross-section for conductor connection	Type	fine-wired	
	nominal	0.25 mm ²	

BL 3.50/02/270F SN OR BX

Weidmüller Interface GmbH & Co. KG
 Klingenbergstraße 26
 D-32758 Detmold
 Germany

www.weidmueller.com

Technical data

wire end ferrule	Stripping length	nominal	8 mm
	Recommended wire-end ferrule	H0,25/10 HBL	
Cross-section for conductor connection	Stripping length	nominal	5 mm
	Recommended wire-end ferrule	H0,25/5	
wire end ferrule	Type	fine-wired	
	nominal	0.34 mm ²	
wire end ferrule	Stripping length	nominal	8 mm
	Recommended wire-end ferrule	H0,34/10 TK	

Reference text The outside diameter of the plastic collar should not be larger than the pitch (P), Length of ferrules is to be chosen depending on the product and the rated voltage.

Rated data acc. to IEC

tested acc. to standard	IEC 60664-1, IEC 61984	Rated current, min. number of poles (Tu=20°C)	12 A
Rated current, max. number of poles (Tu=20°C)	10 A	Rated current, min. number of poles (Tu=40°C)	10 A
Rated current, max. number of poles (Tu=40°C)	8 A	Rated voltage for surge voltage class / pollution degree II/2	320 V
Rated voltage for surge voltage class / pollution degree III/2	160 V	Rated voltage for surge voltage class / pollution degree III/3	160 V
Rated impulse voltage for surge voltage class/ pollution degree II/2	2.5 kV	Rated impulse voltage for surge voltage class/ pollution degree III/2	2.5 kV
Rated impulse voltage for surge voltage class/ contamination degree III/3	2.5 kV	Short-time withstand current resistance	3 x 1s with 100 A

Rated data acc. to CSA

Institute (CSA)	CSA	Certificate No. (CSA)	154685-1318353
Rated voltage (Use group B / CSA)	300 V	Rated voltage (Use group D / CSA)	300 V
Rated current (Use group B / CSA)	10 A	Rated current (Use group D / CSA)	10 A
Wire cross-section, AWG, min.	AWG 28	Wire cross-section, AWG, max.	AWG 14
Reference to approval values	Specifications are maximum values, details - see approval certificate.		

Rated data acc. to UL 1059

Institute (UR)	UR	Certificate No. (UR)	E60693
Rated voltage (Use group B / UL 1059)	300 V	Rated voltage (Use group D / UL 1059)	300 V
Rated current (Use group B / UL 1059)	8 A	Rated current (Use group D / UL 1059)	8 A
Wire cross-section, AWG, min.	AWG 28	Wire cross-section, AWG, max.	AWG 14
Reference to approval values	Specifications are maximum values, details - see approval certificate.		

Packing

Packaging	Box	VPE length	349.00 mm
VPE width	139.00 mm	VPE height	31.00 mm

Type tests

Test: Durability of markings	Standard	DIN EN 61984 section 7.3.2 / 09.02 taking pattern from DIN EN 60068-2-70 / 07.96
	Test	mark of origin, type identification, approval marking SEV, approval marking CSA

BL 3.50/02/270F SN OR BX

Weidmüller Interface GmbH & Co. KG
 Klingenbergstraße 26
 D-32758 Detmold
 Germany

www.weidmueller.com

Technical data

	Evaluation	available
	Test	durability
	Evaluation	passed
Test: Misengagement (Non-interchangeability)	Standard	DIN EN 61984 section 6.3 and 6.9.1 / 09.02, DIN IEC 60512 part 7 section 5 / 05.94
	Test	180° turned with coding elements
	Evaluation	passed
Test: Clampable cross section	Standard	DIN EN 60999-1 section 7 and 9.1 / 12.00, DIN EN 60947-1 section 8.2.4.5.1 / 12.99
	Conductor type	Type of conductor and conductor cross-section solid 0.2 mm ²
		Type of conductor and conductor cross-section stranded 0.2 mm ²
		Type of conductor and conductor cross-section solid 1.5 mm ²
		Type of conductor and conductor cross-section stranded 1.5 mm ²
		Type of conductor and conductor cross-section AWG 28/1
		Type of conductor and conductor cross-section AWG 28/19
		Type of conductor and conductor cross-section AWG 16/1
		Type of conductor and conductor cross-section AWG 16/19
	Evaluation	passed
Test for damage to and accidental loosening of conductors	Standard	DIN EN 60999-1 section 9.4 / 12.00
	Requirement	0.2 kg
	Conductor type	Type of conductor and conductor cross-section AWG 28/1
		Type of conductor and conductor cross-section AWG 28/19
	Evaluation	passed
	Requirement	0.3 kg
	Conductor type	Type of conductor and conductor cross-section 2 × AWG 24/1
		Type of conductor and conductor cross-section 2 × AWG 24/19 with wire end ferrule
	Evaluation	passed
	Requirement	0.4 kg
	Conductor type	Type of conductor and conductor cross-section solid 1.5 mm ²
		Type of conductor and conductor cross-section stranded 1.5 mm ²
		Type of conductor and conductor cross-section AWG 16/7
	Evaluation	passed
Pull-out test	Standard	DIN EN 60999-1 section 9.5 / 12.00

Technical data

Requirement		≥5 N	
Conductor type	Type of conductor and conductor cross-section	AWG 28/1	
	Type of conductor and conductor cross-section	AWG 28/19	
Evaluation		passed	
Requirement		≥10 N	
Conductor type	Type of conductor and conductor cross-section	2 × AWG 24/1	
	Type of conductor and conductor cross-section	2 × AWG 24/19 with wire end ferrule	
Evaluation		passed	
Requirement		≥40 N	
Conductor type	Type of conductor and conductor cross-section	H05V-U1.5	
	Type of conductor and conductor cross-section	H05V-K1.5	
	Type of conductor and conductor cross-section	AWG 16/7	
Evaluation		passed	

Important note

IPC conformity Conformity: The products are developed, manufactured and delivered according international recognized standards and norms and comply with the assured properties in the data sheet resp. fulfill decorative properties in accordance with IPC-A-610 "Class 2". Further claims on the products can be evaluated on request.

- Notes
- Additional variants on request
 - Gold-plated contact surfaces on request
 - Max. outer diameter of the conductor: 2.9 mm
 - Max. outer diameter of the conductor: 2.9 mm
 - Wire end ferrule without plastic collar to DIN 46228/1
 - Wire end ferrule with plastic collar to DIN 46228/4
 - P on drawing = pitch
 - Rated data refer only to the component itself. Clearance and creepage distances to other components are to be designed in accordance with the relevant application standards.
 - In accordance with IEC 61984, OMNIMATE-connectors are connectors without breaking capacity (COC). During designated use, connectors are not allowed to be engaged or disengaged when live or under load
 - Long term storage of the product with average temperature of 50 °C and maximum humidity 70%, 36 months

Classifications

ETIM 8.0	EC002638	ETIM 9.0	EC002638
ETIM 10.0	EC002638	ECLASS 14.0	27-46-02-02
ECLASS 15.0	27-46-02-02		

BL 3.50/02/270F SN OR BX

Weidmüller Interface GmbH & Co. KG
 Klingenbergstraße 26
 D-32758 Detmold
 Germany

www.weidmueller.com

Drawings

Product image

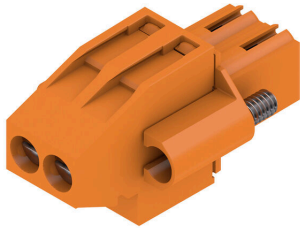

Dimensional drawing



Graph



Graph



Accessories

Coding elements



Only connects what is supposed to be connected: the right connection at the right place.
 Coding elements and locking devices clearly assign connecting elements during the manufacturing process and operation
 The coding elements and locking devices are inserted prior to assembly or during the cable assembly phase. The Weidmüller alternative: configure online using the variant configurator to precode prior to delivery. Incorrect assembly on the circuit board and incorrect plugging of connecting elements is no longer possible. The advantage: no troubleshooting during manufacture and no operational errors by the user.

General ordering data

Type	BL SL 3.5 KO OR	Version
Order No.	1693430000	PCB plug-in connector, Accessories, Coding element, orange, Number
GTIN (EAN)	4008190867447	of poles: 1
Qty.	100 ST	
Type	BL SL 3.5 KO SW	Version
Order No.	1610100000	PCB plug-in connector, Accessories, Coding element, black, Number
GTIN (EAN)	4008190187637	of poles: 1
Qty.	100 ST	

BL 3.50/02/270F SN OR BX

Weidmüller Interface GmbH & Co. KG
 Klingenbergstraße 26
 D-32758 Detmold
 Germany

www.weidmueller.com

Counterpart

SLD 3.50/90



Two-tier pin header for wave soldering in 3.50 mm pitch. The connector is available in open, closed and flange versions. The male connectors provide space for labelling and can be coded. Packed in a cardboard box.

General ordering data

Type	SLD 3.50/04/90 3.2SN OR...	Version
Order No.	1633350000	PCB plug-in connector, male header, open side, THT solder
GTIN (EAN)	4008190257804	connection, 3.50 mm, Number of poles: 4, 90°, Solder pin length (l):
Qty.	50 ST	3.2 mm, tinned, orange, Box

SLD 3.50/90G



Two-tier pin header for wave soldering in 3.50 mm pitch. The connector is available in open, closed and flange versions. The male connectors provide space for labelling and can be coded. Packed in a cardboard box.

General ordering data

Type	SLD 3.50/04/90G 3.2SN O...	Version
Order No.	1633580000	PCB plug-in connector, male header, closed side, THT solder
GTIN (EAN)	4008190258030	connection, 3.50 mm, Number of poles: 4, 90°, Solder pin length (l):
Qty.	50 ST	3.2 mm, tinned, orange, Box

SLD 3.50V/180G



Double-level, staggered pin header for wave soldering at 3.50 mm pitch. They are available in closed and flanged versions. The male connectors provide space for labelling and can be coded.

General ordering data

Type	SLD 3.50V/04/180G 3.2SN...	Version
Order No.	1641110000	PCB plug-in connector, male header, closed side, THT solder
GTIN (EAN)	4008190279516	connection, 3.50 mm, Number of poles: 4, 180°, Solder pin length (l):
Qty.	50 ST	3.2 mm, tinned, orange, Box

BL 3.50/02/270F SN OR BX

Weidmüller Interface GmbH & Co. KG
 Klingenbergstraße 26
 D-32758 Detmold
 Germany

Counterpart

www.weidmueller.com

SLD 3.50V/90G



Double-level, staggered pin header for wave soldering at 3.50 mm pitch. They are available in closed and flanged versions. The male connectors provide space for labelling and can be coded.

General ordering data

Type	SLD 3.50V/04/90G 3.2SN ...	Version
Order No.	1642240000	PCB plug-in connector, male header, closed side, THT solder connection, 3.50 mm, Number of poles: 4, 90°, Solder pin length (l):
GTIN (EAN)	4008190280758	3.2 mm, tinned, orange, Box
Qty.	50 ST	
Type	SLD 3.50V/04/90G 4.5SN ...	Version
Order No.	1642860000	PCB plug-in connector, male header, closed side, THT solder connection, 3.50 mm, Number of poles: 4, 90°, Solder pin length (l):
GTIN (EAN)	4008190281458	4.5 mm, tinned, black, Box
Qty.	50 ST	

SL 3.50/90G



Pin headers for wave soldering in 3.50 mm pitch

- Plugging direction is parallel (90°), straight 180° or angled (135°) to the PCB
- Housing variant: screw flange (F)
- Packed in a cardboard box (BX)
- Pin header can be coded

General ordering data

Type	SL 3.50/02/90G 3.2SN BK...	Version
Order No.	1683240000	PCB plug-in connector, male header, closed side, THT solder connection, 3.50 mm, Number of poles: 2, 90°, Solder pin length (l):
GTIN (EAN)	4008190475352	3.2 mm, tinned, black, Box
Qty.	100 ST	

SL-SMT 3.5/180G Box



High-temperature-resistant male header, 3.50 mm pitch.

- Plugging direction parallel (90°), straight 180° or angled (135°) to PCB
- Housing variants: closed side (G), screw flange (F), solder flange (LF) or snap-on solder flange (RF)
- Optimised for the SMT process
- Pin length 3.2 mm universal for all soldering methods
- Pin length 1.5 mm optimised for reflow soldering methods
- Packed either in a box (BX) or tape-on-reel (RL)
- Male header can be coded

BL 3.50/02/270F SN OR BX

Weidmüller Interface GmbH & Co. KG
 Klingenbergstraße 26
 D-32758 Detmold
 Germany

Counterpart

www.weidmueller.com

General ordering data

Type	SL-SMT 3.50/02/180G 1.5...	Version
Order No.	1752982001	PCB plug-in connector, male header, closed side, THT/THR solder connection, 3.50 mm, Number of poles: 2, 180°, Solder pin length (l):
GTIN (EAN)	4032248130887	1.5 mm, tinned, black, Box
Qty.	100 ST	

SL-SMT 3.5/90G Box



- High-temperature-resistant male header, 3.50 mm pitch.
- Plugging direction parallel (90°), straight 180° or angled (135°) to PCB
 - Housing variants: closed side (G), screw flange (F), solder flange (LF) or snap-on solder flange (RF)
 - Optimised for the SMT process
 - Pin length 3.2 mm universal for all soldering methods
 - Pin length 1.5 mm optimised for reflow soldering methods
 - Packed either in a box (BX) or tape-on-reel (RL)
 - Male header can be coded

General ordering data

Type	SL-SMT 3.50/02/90G 1.5S...	Version
Order No.	1761542001	PCB plug-in connector, male header, closed side, THT/THR solder connection, 3.50 mm, Number of poles: 2, 90°, Solder pin length (l):
GTIN (EAN)	4032248132034	1.5 mm, tinned, black, Box
Qty.	100 ST	

SL 3.50/90

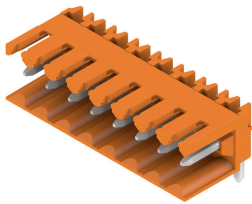

- Pin headers for wave soldering in 3.50 mm pitch
- Plugging direction is parallel (90°), straight 180° or angled (135°) to the PCB
 - Housing variant: screw flange (F)
 - Packed in a cardboard box (BX)
 - Pin header can be coded

General ordering data

Type	SL 3.50/02/90 3.2SN OR ...	Version
Order No.	1597210000	PCB plug-in connector, male header, open side, THT solder connection, 3.50 mm, Number of poles: 2, 90°, Solder pin length (l):
GTIN (EAN)	4008190175320	3.2 mm, tinned, orange, Box
Qty.	100 ST	

BL 3.50/02/270F SN OR BX

Weidmüller Interface GmbH & Co. KG
 Klingenbergstraße 26
 D-32758 Detmold
 Germany

www.weidmueller.com

Counterpart

SL 3.50/180G



- Pin headers for wave soldering in 3.50 mm pitch
- Plugging direction is parallel (90°), straight 180° or angled (135°) to the PCB
 - Housing variant: screw flange (F)
 - Packed in a cardboard box (BX)
 - Pin header can be coded

General ordering data

Type	SL 3.50/02/180G 3.2SN O...	Version
Order No.	1604470000	PCB plug-in connector, male header, closed side, THT solder connection, 3.50 mm, Number of poles: 2, 180°, Solder pin length (l):
GTIN (EAN)	4008190137526	3.2 mm, tinned, orange, Box
Qty.	100 ST	
Type	SL 3.50/02/180G 4.5SN O...	Version
Order No.	1604620000	PCB plug-in connector, male header, closed side, THT solder connection, 3.50 mm, Number of poles: 2, 180°, Solder pin length (l):
GTIN (EAN)	4008190112547	4.5 mm, tinned, orange, Box
Qty.	100 ST	

SL 3.50/180

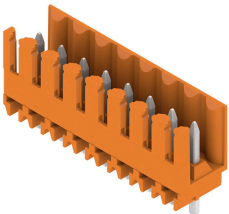

- Pin headers for wave soldering in 3.50 mm pitch
- Plugging direction is parallel (90°), straight 180° or angled (135°) to the PCB
 - Housing variant: screw flange (F)
 - Packed in a cardboard box (BX)
 - Pin header can be coded

General ordering data

Type	SL 3.50/02/180 3.2SN OR...	Version
Order No.	1604770000	PCB plug-in connector, male header, open side, THT solder connection, 3.50 mm, Number of poles: 2, 180°, Solder pin length (l):
GTIN (EAN)	4008190054182	3.2 mm, tinned, orange, Box
Qty.	100 ST	
Type	SL 3.50/02/180 4.5 SN O...	Version
Order No.	1604920000	PCB plug-in connector, male header, open side, THT solder connection, 3.50 mm, Number of poles: 2, 180°, Solder pin length (l):
GTIN (EAN)	4008190117757	4.5 mm, tinned, orange, Box
Qty.	100 ST	

BL 3.50/02/270F SN OR BX

Weidmüller Interface GmbH & Co. KG
 Klingenbergstraße 26
 D-32758 Detmold
 Germany

www.weidmueller.com

Counterpart

SL 3.50/90G

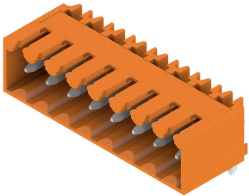

Pin headers for wave soldering in 3.50 mm pitch

- Plugging direction is parallel (90°), straight 180° or angled (135°) to the PCB
- Housing variant: screw flange (F)
- Packed in a cardboard box (BX)
- Pin header can be coded

General ordering data

Type	SL 3.50/02/90G 3.2SN OR...	Version
Order No.	1605070000	PCB plug-in connector, male header, closed side, THT solder
GTIN (EAN)	4008190085100	connection, 3.50 mm, Number of poles: 2, 90°, Solder pin length (l):
Qty.	100 ST	3.2 mm, tinned, orange, Box

SL 3.50/90

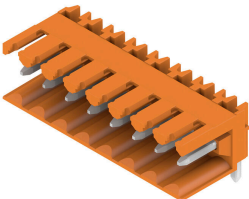

Pin headers for wave soldering in 3.50 mm pitch

- Plugging direction is parallel (90°), straight 180° or angled (135°) to the PCB
- Housing variant: screw flange (F)
- Packed in a cardboard box (BX)
- Pin header can be coded

General ordering data

Type	SL 3.50/02/90 4.5SN OR ...	Version
Order No.	1605370000	PCB plug-in connector, male header, open side, THT solder
GTIN (EAN)	4008190161071	connection, 3.50 mm, Number of poles: 2, 90°, Solder pin length (l):
Qty.	100 ST	4.5 mm, tinned, orange, Box

SL 3.50/180G

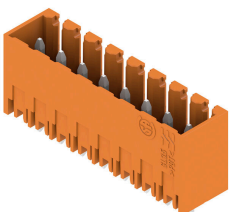

Pin headers for wave soldering in 3.50 mm pitch

- Plugging direction is parallel (90°), straight 180° or angled (135°) to the PCB
- Housing variant: screw flange (F)
- Packed in a cardboard box (BX)
- Pin header can be coded

General ordering data

Type	SL 3.50/02/180G 3.2SN D...	Version
Order No.	1607350000	PCB plug-in connector, male header, closed side, THT solder
GTIN (EAN)	4008190131746	connection, 3.50 mm, Number of poles: 2, 180°, Solder pin length (l):
Qty.	100 ST	3.2 mm, tinned, Signal green, Box

BL 3.50/02/270F SN OR BX

Weidmüller Interface GmbH & Co. KG
Klingenbergstraße 26
D-32758 Detmold
Germany

www.weidmueller.com

Counterpart

SL 3.50/90



- Pin headers for wave soldering in 3.50 mm pitch
- Plugging direction is parallel (90°), straight 180° or angled (135°) to the PCB
 - Housing variant: screw flange (F)
 - Packed in a cardboard box (BX)
 - Pin header can be coded

General ordering data

Type	SL 3.50/02/90 4.5 SN BK...	Version
Order No.	1614130000	PCB plug-in connector, male header, open side, THT solder
GTIN (EAN)	4008190019600	connection, 3.50 mm, Number of poles: 2, 90°, Solder pin length (l):
Qty.	100 ST	4.5 mm, tinned, black, Box

SL 3.50/90G

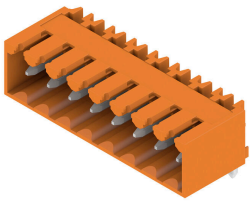

- Pin headers for wave soldering in 3.50 mm pitch
- Plugging direction is parallel (90°), straight 180° or angled (135°) to the PCB
 - Housing variant: screw flange (F)
 - Packed in a cardboard box (BX)
 - Pin header can be coded

General ordering data

Type	SL 3.50/02/90G 4.5 SN B...	Version
Order No.	1614160000	PCB plug-in connector, male header, closed side, THT solder
GTIN (EAN)	4008190020088	connection, 3.50 mm, Number of poles: 2, 90°, Solder pin length (l):
Qty.	100 ST	4.5 mm, tinned, black, Box

SL 3.50/180

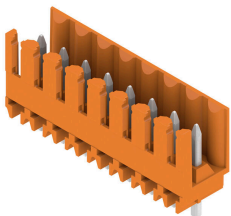

- Pin headers for wave soldering in 3.50 mm pitch
- Plugging direction is parallel (90°), straight 180° or angled (135°) to the PCB
 - Housing variant: screw flange (F)
 - Packed in a cardboard box (BX)
 - Pin header can be coded

General ordering data

Type	SL 3.50/02/180 4.5 SN B...	Version
Order No.	1614210000	PCB plug-in connector, male header, open side, THT solder
GTIN (EAN)	4008190021092	connection, 3.50 mm, Number of poles: 2, 180°, Solder pin length (l):
Qty.	100 ST	4.5 mm, tinned, black, Box

BL 3.50/02/270F SN OR BX

Weidmüller Interface GmbH & Co. KG
 Klingenbergstraße 26
 D-32758 Detmold
 Germany

www.weidmueller.com

Counterpart

SL 3.50/180G



Pin headers for wave soldering in 3.50 mm pitch

- Plugging direction is parallel (90°), straight 180° or angled (135°) to the PCB
- Housing variant: screw flange (F)
- Packed in a cardboard box (BX)
- Pin header can be coded

General ordering data

Type	SL 3.50/02/180G 4.5 SN ...	Version
Order No.	1614240000	PCB plug-in connector, male header, closed side, THT solder
GTIN (EAN)	4008190021276	connection, 3.50 mm, Number of poles: 2, 180°, Solder pin length (l):
Qty.	100 ST	4.5 mm, tinned, black, Box

SL-SMT 3.5/180G Box



High-temperature-resistant male header, 3.50 mm pitch.

- Plugging direction parallel (90°), straight 180° or angled (135°) to PCB
- Housing variants: closed side (G), screw flange (F), solder flange (LF) or snap-on solder flange (RF)
- Optimised for the SMT process
- Pin length 3.2 mm universal for all soldering methods
- Pin length 1.5 mm optimised for reflow soldering methods
- Packed either in a box (BX) or tape-on-reel (RL)
- Male header can be coded

General ordering data

Type	SL-SMT 3.50/02/180G 3.2...	Version
Order No.	1842320000	PCB plug-in connector, male header, closed side, THT/THR solder
GTIN (EAN)	4032248353668	connection, 3.50 mm, Number of poles: 2, 180°, Solder pin length (l):
Qty.	100 ST	3.2 mm, tinned, black, Box

SL-SMT 3.5/90G Box



High-temperature-resistant male header, 3.50 mm pitch.

- Plugging direction parallel (90°), straight 180° or angled (135°) to PCB
- Housing variants: closed side (G), screw flange (F), solder flange (LF) or snap-on solder flange (RF)
- Optimised for the SMT process
- Pin length 3.2 mm universal for all soldering methods
- Pin length 1.5 mm optimised for reflow soldering methods
- Packed either in a box (BX) or tape-on-reel (RL)
- Male header can be coded

BL 3.50/02/270F SN OR BX

Weidmüller Interface GmbH & Co. KG
 Klingenbergstraße 26
 D-32758 Detmold
 Germany

Counterpart

www.weidmueller.com

General ordering data

Type	SL-SMT 3.50/02/90G 3.2S...	Version
Order No.	1841630000	PCB plug-in connector, male header, closed side, THT/THR solder
GTIN (EAN)	4032248352784	connection, 3.50 mm, Number of poles: 2, 90°, Solder pin length (l):
Qty.	100 ST	3.2 mm, tinned, black, Box

SL-SMT 3.5/180G Tape



- High-temperature-resistant male header, 3.50 mm pitch.
- Plugging direction parallel (90°), straight 180° or angled (135°) to PCB
 - Housing variants: closed side (G), screw flange (F), solder flange (LF) or snap-on solder flange (RF)
 - Optimised for the SMT process
 - Pin length 3.2 mm universal for all soldering methods
 - Pin length 1.5 mm optimised for reflow soldering methods
 - Packed either in a box (BX) or tape-on-reel (RL)
 - Male header can be coded

General ordering data

Type	SL-SMT 3.50/02/180G 1.5...	Version
Order No.	1752984002	PCB plug-in connector, male header, closed side, THT/THR solder
GTIN (EAN)	4032248193097	connection, 3.50 mm, Number of poles: 2, 180°, Solder pin length (l):
Qty.	265 ST	1.5 mm, tinned, black, Tape

SL-SMT 3.5/90G Tape



- High-temperature-resistant male header, 3.50 mm pitch.
- Plugging direction parallel (90°), straight 180° or angled (135°) to PCB
 - Housing variants: closed side (G), screw flange (F), solder flange (LF) or snap-on solder flange (RF)
 - Optimised for the SMT process
 - Pin length 3.2 mm universal for all soldering methods
 - Pin length 1.5 mm optimised for reflow soldering methods
 - Packed either in a box (BX) or tape-on-reel (RL)
 - Male header can be coded

General ordering data

Type	SL-SMT 3.50/02/90G 1.5S...	Version
Order No.	1761544002	PCB plug-in connector, male header, closed side, THT/THR solder
GTIN (EAN)	4032248193325	connection, 3.50 mm, Number of poles: 2, 90°, Solder pin length (l):
Qty.	385 ST	1.5 mm, tinned, black, Tape

BL 3.50/02/270F SN OR BX

Weidmüller Interface GmbH & Co. KG
 Klingenbergstraße 26
 D-32758 Detmold
 Germany

www.weidmueller.com

Counterpart

SL-THR 3.5/135F



High-temperature-resistant male header, 3.50 mm pitch.

- Plugging direction parallel (90°), straight 180° or angled (135°) to PCB
- Housing variants: closed side (G), screw flange (F), solder flange (LF) or snap-on solder flange (RF)
- Optimised for the SMT process
- Pin length 3.2 mm universal for all soldering methods
- Pin length 1.5 mm optimised for reflow soldering methods
- Packed either in a box (BX) or tape-on-reel (RL)
- Male header can be coded

General ordering data

Type	SL-SMT 3.50/02/135F 3.2...	Version
Order No.	1003510000	PCB plug-in connector, male header, Flange, THT/THR solder
GTIN (EAN)	4032248700141	connection, 3.50 mm, Number of poles: 2, 135°, Solder pin length (l):
Qty.	132 ST	3.2 mm, tinned, black, Box

SL 3.50/180F

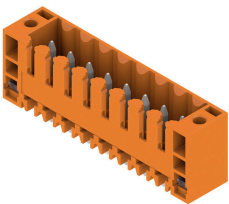

Pin headers for wave soldering in 3.50 mm pitch

- Plugging direction is parallel (90°), straight 180° or angled (135°) to the PCB
- Housing variant: screw flange (F)
- Packed in a cardboard box (BX)
- Pin header can be coded

General ordering data

Type	SL 3.50/02/180F 4.5 SN ...	Version
Order No.	1618690000	PCB plug-in connector, male header, Flange, THT solder connection,
GTIN (EAN)	4008190126452	3.50 mm, Number of poles: 2, 180°, Solder pin length (l): 4.5 mm,
Qty.	100 ST	tinned, orange, Box

SLD 3.50/90F

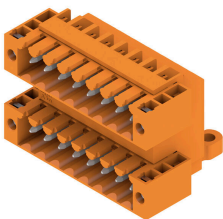

Two-tier pin header for wave soldering in 3.50 mm pitch. The connector is available in open, closed and flange versions. The male connectors provide space for labelling and can be coded. Packed in a cardboard box.

BL 3.50/02/270F SN OR BX

Weidmüller Interface GmbH & Co. KG
 Klingenbergstraße 26
 D-32758 Detmold
 Germany

www.weidmueller.com

Counterpart

General ordering data

Type	SLD 3.50/04/90F 3.2SN O...	Version
Order No.	1633810000	PCB plug-in connector, male header, Flange, THT solder connection,
GTIN (EAN)	4008190258269	3.50 mm, Number of poles: 4, 90°, Solder pin length (l): 3.2 mm,
Qty.	50 ST	tinned, orange, Box

SLD 3.50V/180F

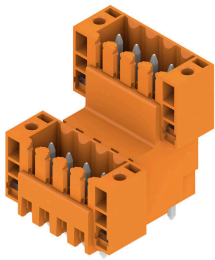

Double-level, staggered pin header for wave soldering at 3.50 mm pitch. They are available in closed and flanged versions. The male connectors provide space for labelling and can be coded.

General ordering data

Type	SLD 3.50 V/04/180F 3.2 ...	Version
Order No.	1641240000	PCB plug-in connector, male header, Flange, THT solder connection,
GTIN (EAN)	4008190279646	3.50 mm, Number of poles: 4, 180°, Solder pin length (l): 3.2 mm,
Qty.	50 ST	tinned, orange, Box

SLD 3.50V/90F

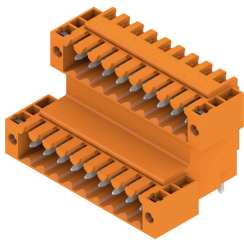

Double-level, staggered pin header for wave soldering at 3.50 mm pitch. They are available in closed and flanged versions. The male connectors provide space for labelling and can be coded.

General ordering data

Type	SLD 3.50 V/04/90F 3.2 S...	Version
Order No.	1642370000	PCB plug-in connector, male header, Flange, THT solder connection,
GTIN (EAN)	4008190280895	3.50 mm, Number of poles: 4, 90°, Solder pin length (l): 3.2 mm,
Qty.	50 ST	tinned, orange, Box

BL 3.50/02/270F SN OR BX

Weidmüller Interface GmbH & Co. KG
 Klingenbergstraße 26
 D-32758 Detmold
 Germany

www.weidmueller.com

Counterpart

SL 3.50/135F



Pin headers for wave soldering in 3.50 mm pitch

- Plugging direction is parallel (90°), straight 180° or angled (135°) to the PCB
- Housing variant: screw flange (F)
- Packed in a cardboard box (BX)
- Pin header can be coded

General ordering data

Type	SL 3.50/02/135F 3.2SN O...	Version
Order No.	1643330000	PCB plug-in connector, male header, Flange, THT solder connection,
GTIN (EAN)	4008190282097	3.50 mm, Number of poles: 2, 135°, Solder pin length (l): 3.2 mm,
Qty.	132 ST	tinned, orange, Box

SL 3.50/90F

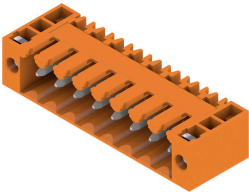

Pin headers for wave soldering in 3.50 mm pitch

- Plugging direction is parallel (90°), straight 180° or angled (135°) to the PCB
- Housing variant: screw flange (F)
- Packed in a cardboard box (BX)
- Pin header can be coded

General ordering data

Type	SL 3.50/02/90F 3.2SN BK...	Version
Order No.	1719980000	PCB plug-in connector, male header, Flange, THT solder connection,
GTIN (EAN)	4008190354268	3.50 mm, Number of poles: 2, 90°, Solder pin length (l): 3.2 mm,
Qty.	100 ST	tinned, black, Box

SL-SMT 3.5/180F Box



High-temperature-resistant male header, 3.50 mm pitch.

- Plugging direction parallel (90°), straight 180° or angled (135°) to PCB
- Housing variants: closed side (G), screw flange (F), solder flange (LF) or snap-on solder flange (RF)
- Optimised for the SMT process
- Pin length 3.2 mm universal for all soldering methods
- Pin length 1.5 mm optimised for reflow soldering methods
- Packed either in a box (BX) or tape-on-reel (RL)
- Male header can be coded

BL 3.50/02/270F SN OR BX

Weidmüller Interface GmbH & Co. KG
 Klingenbergstraße 26
 D-32758 Detmold
 Germany

www.weidmueller.com

Counterpart

General ordering data

Type	SL-SMT 3.50/02/180F 1.5...	Version
Order No.	1760962001	PCB plug-in connector, male header, Flange, THT/THR solder
GTIN (EAN)	4032248131532	connection, 3.50 mm, Number of poles: 2, 180°, Solder pin length (l):
Qty.	132 ST	1.5 mm, tinned, black, Box

SL-SMT 3.5/90F Box

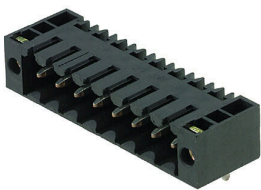

- High-temperature-resistant male header, 3.50 mm pitch.
- Plugging direction parallel (90°), straight 180° or angled (135°) to PCB
 - Housing variants: closed side (G), screw flange (F), solder flange (LF) or snap-on solder flange (RF)
 - Optimised for the SMT process
 - Pin length 3.2 mm universal for all soldering methods
 - Pin length 1.5 mm optimised for reflow soldering methods
 - Packed either in a box (BX) or tape-on-reel (RL)
 - Male header can be coded

General ordering data

Type	SL-SMT 3.50/02/90F 1.5S...	Version
Order No.	1762002001	PCB plug-in connector, male header, Flange, THT/THR solder
GTIN (EAN)	4032248132416	connection, 3.50 mm, Number of poles: 2, 90°, Solder pin length (l):
Qty.	132 ST	1.5 mm, tinned, black, Box

SL 3.50/90F

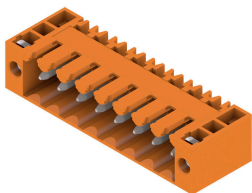

- Pin headers for wave soldering in 3.50 mm pitch
- Plugging direction is parallel (90°), straight 180° or angled (135°) to the PCB
 - Housing variant: screw flange (F)
 - Packed in a cardboard box (BX)
 - Pin header can be coded

General ordering data

Type	SL 3.50/02/90F 3.2SN OR...	Version
Order No.	1607040000	PCB plug-in connector, male header, Flange, THT solder connection,
GTIN (EAN)	4008190061234	3.50 mm, Number of poles: 2, 90°, Solder pin length (l): 3.2 mm,
Qty.	100 ST	tinned, orange, Box

BL 3.50/02/270F SN OR BX

Weidmüller Interface GmbH & Co. KG
 Klingenbergstraße 26
 D-32758 Detmold
 Germany

Counterpart

www.weidmueller.com

SL 3.50/180F



Pin headers for wave soldering in 3.50 mm pitch

- Plugging direction is parallel (90°), straight 180° or angled (135°) to the PCB
- Housing variant: screw flange (F)
- Packed in a cardboard box (BX)
- Pin header can be coded

General ordering data

Type	SL 3.50/02/180F 3.2SN O...	Version
Order No.	1607500000	PCB plug-in connector, male header, Flange, THT solder connection,
GTIN (EAN)	4008190180317	3.50 mm, Number of poles: 2, 180°, Solder pin length (l): 3.2 mm,
Qty.	100 ST	tinned, orange, Box

SL 3.50/90F

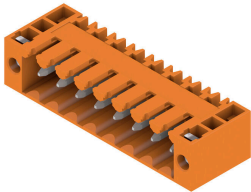

Pin headers for wave soldering in 3.50 mm pitch

- Plugging direction is parallel (90°), straight 180° or angled (135°) to the PCB
- Housing variant: screw flange (F)
- Packed in a cardboard box (BX)
- Pin header can be coded

General ordering data

Type	SL 3.50/02/90F 4.5 SN B...	Version
Order No.	1615530000	PCB plug-in connector, male header, Flange, THT solder connection,
GTIN (EAN)	4008190056551	3.50 mm, Number of poles: 2, 90°, Solder pin length (l): 4.5 mm,
Qty.	100 ST	tinned, black, Box

SL 3.50/180F



Pin headers for wave soldering in 3.50 mm pitch

- Plugging direction is parallel (90°), straight 180° or angled (135°) to the PCB
- Housing variant: screw flange (F)
- Packed in a cardboard box (BX)
- Pin header can be coded

General ordering data

Type	SL 3.50/02/180F 4.5 SN ...	Version
Order No.	1616140000	PCB plug-in connector, male header, Flange, THT solder connection,
GTIN (EAN)	4008190067854	3.50 mm, Number of poles: 2, 180°, Solder pin length (l): 4.5 mm,
Qty.	100 ST	tinned, black, Box

BL 3.50/02/270F SN OR BX

Weidmüller Interface GmbH & Co. KG
 Klingenbergstraße 26
 D-32758 Detmold
 Germany

Counterpart

www.weidmueller.com

SL 3.50/90F



Pin headers for wave soldering in 3.50 mm pitch

- Plugging direction is parallel (90°), straight 180° or angled (135°) to the PCB
- Housing variant: screw flange (F)
- Packed in a cardboard box (BX)
- Pin header can be coded

General ordering data

Type	SL 3.50/02/90F 4.5 SN O...	Version
Order No.	1618060000	PCB plug-in connector, male header, Flange, THT solder connection,
GTIN (EAN)	4008190116132	3.50 mm, Number of poles: 2, 90°, Solder pin length (l): 4.5 mm,
Qty.	100 ST	tinned, orange, Box

SL-SMT 3.5/90LF Box

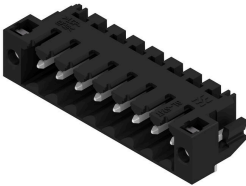

High-temperature-resistant male header, 3.50 mm pitch.

- Plugging direction parallel (90°), straight 180° or angled (135°) to PCB
- Housing variants: closed side (G), screw flange (F), solder flange (LF) or snap-on solder flange (RF)
- Optimised for the SMT process
- Pin length 3.2 mm universal for all soldering methods
- Pin length 1.5 mm optimised for reflow soldering methods
- Packed either in a box (BX) or tape-on-reel (RL)
- Male header can be coded

General ordering data

Type	SL-SMT 3.50/02/90LF 3.2...	Version
Order No.	1841860000	PCB plug-in connector, male header, Solder flange, THT/THR solder
GTIN (EAN)	4032248353217	connection, 3.50 mm, Number of poles: 2, 90°, Solder pin length (l):
Qty.	132 ST	3.2 mm, tinned, black, Box
Type	SL-SMT 3.50/02/90LF 1.5...	Version
Order No.	1804940000	PCB plug-in connector, male header, Solder flange, THT/THR solder
GTIN (EAN)	4032248268849	connection, 3.50 mm, Number of poles: 2, 90°, Solder pin length (l):
Qty.	132 ST	1.5 mm, tinned, black, Box

BL 3.50/02/270F SN OR BX

Weidmüller Interface GmbH & Co. KG

Klingenbergstraße 26

D-32758 Detmold

Germany

www.weidmueller.com

Counterpart

SL-SMT 3.5/180LF Box

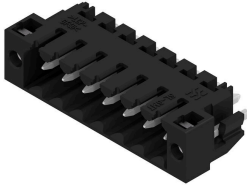

High-temperature-resistant male header, 3.50 mm pitch.

- Plugging direction parallel (90°), straight 180° or angled (135°) to PCB
- Housing variants: closed side (G), screw flange (F), solder flange (LF) or snap-on solder flange (RF)
- Optimised for the SMT process
- Pin length 3.2 mm universal for all soldering methods
- Pin length 1.5 mm optimised for reflow soldering methods
- Packed either in a box (BX) or tape-on-reel (RL)
- Male header can be coded

General ordering data

Type	SL-SMT 3.50/02/180LF 3...	Version
Order No.	1842540000	PCB plug-in connector, male header, Solder flange, THT/THR solder
GTIN (EAN)	4032248353903	connection, 3.50 mm, Number of poles: 2, 180°, Solder pin length (l):
Qty.	132 ST	3.2 mm, tinned, black, Box
Type	SL-SMT 3.50/02/180LF 1...	Version
Order No.	1804700000	PCB plug-in connector, male header, Solder flange, THT/THR solder
GTIN (EAN)	4032248268511	connection, 3.50 mm, Number of poles: 2, 180°, Solder pin length (l):
Qty.	132 ST	1.5 mm, tinned, black, Box

SL-SMT 3.5/90F Box

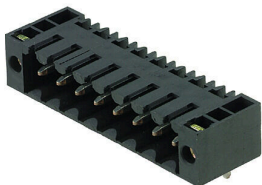

High-temperature-resistant male header, 3.50 mm pitch.

- Plugging direction parallel (90°), straight 180° or angled (135°) to PCB
- Housing variants: closed side (G), screw flange (F), solder flange (LF) or snap-on solder flange (RF)
- Optimised for the SMT process
- Pin length 3.2 mm universal for all soldering methods
- Pin length 1.5 mm optimised for reflow soldering methods
- Packed either in a box (BX) or tape-on-reel (RL)
- Male header can be coded

General ordering data

Type	SL-SMT 3.50/02/90F 3.2S...	Version
Order No.	1842080000	PCB plug-in connector, male header, Flange, THT/THR solder
GTIN (EAN)	4032248353439	connection, 3.50 mm, Number of poles: 2, 90°, Solder pin length (l):
Qty.	132 ST	3.2 mm, tinned, black, Box

BL 3.50/02/270F SN OR BX

Weidmüller Interface GmbH & Co. KG

Klingenbergstraße 26

D-32758 Detmold

Germany

www.weidmueller.com

Counterpart

SL-SMT 3.5/180LF Tape



High-temperature-resistant male header, 3.50 mm pitch.

- Plugging direction parallel (90°), straight 180° or angled (135°) to PCB
- Housing variants: closed side (G), screw flange (F), solder flange (LF) or snap-on solder flange (RF)
- Optimised for the SMT process
- Pin length 3.2 mm universal for all soldering methods
- Pin length 1.5 mm optimised for reflow soldering methods
- Packed either in a box (BX) or tape-on-reel (RL)
- Male header can be coded

General ordering data

Type	SL-SMT 3.50/02/180LF 1...	Version
Order No.	1805210000	PCB plug-in connector, male header, Solder flange, THT/THR solder
GTIN (EAN)	4032248269099	connection, 3.50 mm, Number of poles: 2, 180°, Solder pin length (l):
Qty.	265 ST	1.5 mm, tinned, black, Tape

SL-SMT 3.5/90LF Tape



High-temperature-resistant male header, 3.50 mm pitch.

- Plugging direction parallel (90°), straight 180° or angled (135°) to PCB
- Housing variants: closed side (G), screw flange (F), solder flange (LF) or snap-on solder flange (RF)
- Optimised for the SMT process
- Pin length 3.2 mm universal for all soldering methods
- Pin length 1.5 mm optimised for reflow soldering methods
- Packed either in a box (BX) or tape-on-reel (RL)
- Male header can be coded

General ordering data

Type	SL-SMT 3.50/02/90LF 1.5...	Version
Order No.	1805310000	PCB plug-in connector, male header, Solder flange, THT/THR solder
GTIN (EAN)	4032248269761	connection, 3.50 mm, Number of poles: 2, 90°, Solder pin length (l):
Qty.	385 ST	1.5 mm, tinned, black, Tape

SL-SMT 3.5/180F Box

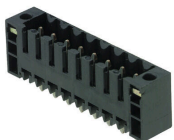

High-temperature-resistant male header, 3.50 mm pitch.

- Plugging direction parallel (90°), straight 180° or angled (135°) to PCB
- Housing variants: closed side (G), screw flange (F), solder flange (LF) or snap-on solder flange (RF)
- Optimised for the SMT process
- Pin length 3.2 mm universal for all soldering methods
- Pin length 1.5 mm optimised for reflow soldering methods
- Packed either in a box (BX) or tape-on-reel (RL)
- Male header can be coded

BL 3.50/02/270F SN OR BX

Weidmüller Interface GmbH & Co. KG
Klingenbergstraße 26
D-32758 Detmold
Germany

www.weidmueller.com

Counterpart

General ordering data

Type	SL-SMT 3.50/02/180F 3.2...	Version
Order No.	1842770000	PCB plug-in connector, male header, Flange, THT/THR solder
GTIN (EAN)	4032248354139	connection, 3.50 mm, Number of poles: 2, 180°, Solder pin length (l):
Qty.	132 ST	3.2 mm, tinned, black, Box