

## BL 3.50/24/90F SN OR BX

**Weidmüller Interface GmbH & Co. KG**  
 Klingenbergstraße 26  
 D-32758 Detmold  
 Germany

www.weidmueller.com

### Product image

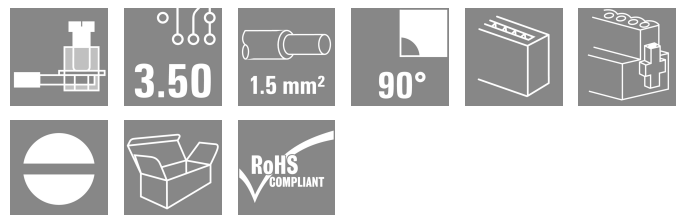
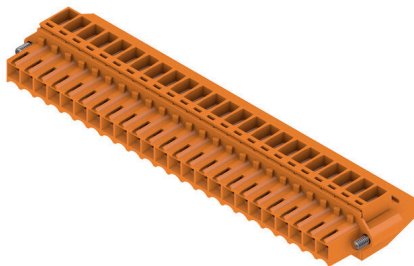

Female connectors with clamping yoke screw system for connecting conductors at 3.50 mm pitch. They provide space for labelling and can be coded.

### General ordering data

Version	PCB plug-in connector, female plug, 3.50 mm, Number of poles: 24, 90°, Clamping yoke connection, Clamping range, max. : 1.5 mm², Box
Order No.	<a href="#">1639230000</a>
Type	BL 3.50/24/90F SN OR BX
GTIN (EAN)	4008190276775
Qty.	18 items
Product data	IEC: 320 V / 12 A / 0.2 - 1.5 mm² UL: 300 V / 8 A / AWG 28 - AWG 14
Packaging	Box

## BL 3.50/24/90F SN OR BX

**Weidmüller Interface GmbH & Co. KG**  
 Klingenbergstraße 26  
 D-32758 Detmold  
 Germany

www.weidmueller.com

## Technical data

### Approvals

Approvals



ROHS	Conform
UL File Number Search	<a href="#">UL Website</a>
Certificate No. (UR)	E60693

### Dimensions and weights

Depth	22.45 mm	Depth (inches)	0.8839 inch
Height	12 mm	Height (inches)	0.4724 inch
Width	91 mm	Width (inches)	3.5827 inch
Net weight	24.5 g		

### Environmental Product Compliance

RoHS Compliance Status	Compliant without exemption		
REACH SVHC	No SVHC above 0.1 wt%		
Product Carbon Footprint	Cradle to gate	0,910 kg CO2 eq.	

### System Parameters

Product family	OMNIMATE Signal - series BL/SL 3.50		
Type of connection	Field connection		
Wire connection method	Clamping yoke connection		
Pitch in mm (P)	3.50 mm		
Pitch in inches (P)	0.138 "		
Conductor outlet direction	90°		
Number of poles	24		
L1 in mm	80.50 mm		
L1 in inches	3.169 "		
Number of rows	1		
Pin series quantity	1		
Rated cross-section	1.5 mm <sup>2</sup>		
Touch-safe protection acc. to DIN VDE 57 106	Safe from finger touch		
Touch-safe protection acc. to DIN VDE 0470	IP20 plugged/ IP10 unplugged		
Protection degree	IP20, when fully mounted		
Volume resistance	≤5 mΩ		
Can be coded	Yes		
Stripping length	6 mm		
Clamping screw	M 2		
Screwdriver blade	0.4 x 2.5		
Screwdriver blade standard	DIN 5264		
Plugging cycles	25		
Plugging force/pole, max.	7 N		
Pulling force/pole, max.	5 N		
Tightening torque	Torque type		Wire connection
	Usage information		Tightening torque
			min. 0.2 Nm
	Usage information		max. 0.25 Nm
Torque type			Screw flange
Usage information		Tightening torque	
		min. 0.15 Nm	
Usage information		max. 0.2 Nm	

## BL 3.50/24/90F SN OR BX

**Weidmüller Interface GmbH & Co. KG**  
 Klingenbergstraße 26  
 D-32758 Detmold  
 Germany

www.weidmueller.com

## Technical data

### Material data

Insulating material	PBT	Colour	orange
Colour chart (similar)	RAL 2000	Insulating material group	Illa
Comparative Tracking Index (CTI)	≥ 200	Insulation resistance	≥ 108 Ω
Moisture Level (MSL)		UL 94 flammability rating	V-0
Contact material	Cu-alloy	Contact surface	tinned
Layer structure of plug contact	4...8 μm Sn hot-dip tinned	Storage temperature, min.	-40 °C
Storage temperature, max.	70 °C	Operating temperature, min.	-50 °C
Operating temperature, max.	100 °C	Temperature range, installation, min.	-30 °C
Temperature range, installation, max.	100 °C		

### Conductors suitable for connection

Clamping range, min.	0.08 mm <sup>2</sup>
Clamping range, max.	1.5 mm <sup>2</sup>
Wire connection cross section AWG, min.	AWG 28
Wire connection cross section AWG, max.	AWG 14
Solid, min. H05(07) V-U	0.2 mm <sup>2</sup>
Solid, max. H05(07) V-U	1.5 mm <sup>2</sup>
Flexible, min. H05(07) V-K	0.2 mm <sup>2</sup>
Flexible, max. H05(07) V-K	1.5 mm <sup>2</sup>
w. plastic collar ferrule, DIN 46228 pt 4, 0.2 mm <sup>2</sup> min.	
w. plastic collar ferrule, DIN 46228 pt 4, 1.5 mm <sup>2</sup> max.	
w. wire end ferrule, DIN 46228 pt 1, min.	0.2 mm <sup>2</sup>
w. wire end ferrule, DIN 46228 pt 1, max.	1.5 mm <sup>2</sup>
Plug gauge in accordance with EN 60999 a x b; ø	2.4 mm x 1.5 mm

Clampable conductor	Cross-section for conductor connection	Type	fine-wired
		nominal	0.5 mm <sup>2</sup>
wire end ferrule	wire end ferrule	Stripping length	nominal 8 mm
		Recommended wire-end ferrule	<a href="#">H0.5/12 OR</a>
		Stripping length	nominal 6 mm
		Recommended wire-end ferrule	<a href="#">H0.5/6</a>
Cross-section for conductor connection	wire end ferrule	Type	fine-wired
		nominal	0.75 mm <sup>2</sup>
		Stripping length	nominal 8 mm
		Recommended wire-end ferrule	<a href="#">H0.75/12 W</a>
Cross-section for conductor connection	wire end ferrule	Stripping length	nominal 6 mm
		Recommended wire-end ferrule	<a href="#">H0.75/6</a>
		Type	fine-wired
		nominal	1 mm <sup>2</sup>
Cross-section for conductor connection	wire end ferrule	Stripping length	nominal 8 mm
		Recommended wire-end ferrule	<a href="#">H1.0/12 GE</a>
		Stripping length	nominal 6 mm
		Recommended wire-end ferrule	<a href="#">H1.0/6</a>
Cross-section for conductor connection	wire end ferrule	Type	fine-wired
		nominal	0.25 mm <sup>2</sup>

**BL 3.50/24/90F SN OR BX**

**Weidmüller Interface GmbH & Co. KG**  
 Klingenbergstraße 26  
 D-32758 Detmold  
 Germany

www.weidmueller.com

**Technical data**

wire end ferrule	Stripping length	nominal	8 mm
	Recommended wire-end ferrule	<a href="#">H0,25/10 HBL</a>	
Cross-section for conductor connection	Stripping length	nominal	5 mm
	Recommended wire-end ferrule	<a href="#">H0,25/5</a>	
wire end ferrule	Type	fine-wired	
	nominal	0.34 mm <sup>2</sup>	
wire end ferrule	Stripping length	nominal	8 mm
	Recommended wire-end ferrule	<a href="#">H0,34/10 TK</a>	

Reference text The outside diameter of the plastic collar should not be larger than the pitch (P), Length of ferrules is to be chosen depending on the product and the rated voltage.

**Rated data acc. to IEC**

tested acc. to standard	IEC 60664-1, IEC 61984	Rated current, min. number of poles (Tu=20°C)	12 A
Rated current, max. number of poles (Tu=20°C)	10 A	Rated current, min. number of poles (Tu=40°C)	10 A
Rated current, max. number of poles (Tu=40°C)	8 A	Rated voltage for surge voltage class / pollution degree II/2	320 V
Rated voltage for surge voltage class / pollution degree III/2	160 V	Rated voltage for surge voltage class / pollution degree III/3	160 V
Rated impulse voltage for surge voltage class/ pollution degree II/2	2.5 kV	Rated impulse voltage for surge voltage class/ pollution degree III/2	2.5 kV
Rated impulse voltage for surge voltage class/ contamination degree III/3	2.5 kV	Short-time withstand current resistance	3 x 1s with 100 A

**Rated data acc. to CSA**

Institute (CSA)	CSA	Certificate No. (CSA)	154685-1318353
Rated voltage (Use group B / CSA)	300 V	Rated voltage (Use group D / CSA)	300 V
Rated current (Use group B / CSA)	10 A	Rated current (Use group D / CSA)	10 A
Wire cross-section, AWG, min.	AWG 28	Wire cross-section, AWG, max.	AWG 14
Reference to approval values	Specifications are maximum values, details - see approval certificate.		

**Rated data acc. to UL 1059**

Institute (UR)	UR	Certificate No. (UR)	E60693
Rated voltage (Use group B / UL 1059)	300 V	Rated voltage (Use group D / UL 1059)	300 V
Rated current (Use group B / UL 1059)	8 A	Rated current (Use group D / UL 1059)	8 A
Wire cross-section, AWG, min.	AWG 28	Wire cross-section, AWG, max.	AWG 14
Reference to approval values	Specifications are maximum values, details - see approval certificate.		

**Packing**

Packaging	Box	VPE length	350.00 mm
VPE width	135.00 mm	VPE height	31.00 mm

**Type tests**

Test: Durability of markings	Standard	DIN EN 61984 section 7.3.2 / 09.02 taking pattern from DIN EN 60068-2-70 / 07.96
	Test	mark of origin, type identification, approval marking SEV, approval marking CSA

**BL 3.50/24/90F SN OR BX**

**Weidmüller Interface GmbH & Co. KG**  
 Klingenbergstraße 26  
 D-32758 Detmold  
 Germany

www.weidmueller.com

**Technical data**

	Evaluation	available
	Test	durability
	Evaluation	passed
Test: Misengagement (Non-interchangeability)	Standard	DIN EN 61984 section 6.3 and 6.9.1 / 09.02, DIN IEC 60512 part 7 section 5 / 05.94
	Test	180° turned with coding elements
	Evaluation	passed
Test: Clampable cross section	Standard	DIN EN 60999-1 section 7 and 9.1 / 12.00, DIN EN 60947-1 section 8.2.4.5.1 / 12.99
	Conductor type	Type of conductor and conductor cross-section solid 0.2 mm <sup>2</sup>
		Type of conductor and conductor cross-section stranded 0.2 mm <sup>2</sup>
		Type of conductor and conductor cross-section solid 1.5 mm <sup>2</sup>
		Type of conductor and conductor cross-section stranded 1.5 mm <sup>2</sup>
		Type of conductor and conductor cross-section AWG 28/1
		Type of conductor and conductor cross-section AWG 28/19
		Type of conductor and conductor cross-section AWG 16/1
		Type of conductor and conductor cross-section AWG 16/19
	Evaluation	passed
Test for damage to and accidental loosening of conductors	Standard	DIN EN 60999-1 section 9.4 / 12.00
	Requirement	0.2 kg
	Conductor type	Type of conductor and conductor cross-section AWG 28/1
		Type of conductor and conductor cross-section AWG 28/19
	Evaluation	passed
	Requirement	0.3 kg
	Conductor type	Type of conductor and conductor cross-section 2 × AWG 24/1
		Type of conductor and conductor cross-section 2 × AWG 24/19 with wire end ferrule
	Evaluation	passed
	Requirement	0.4 kg
	Conductor type	Type of conductor and conductor cross-section solid 1.5 mm <sup>2</sup>
		Type of conductor and conductor cross-section stranded 1.5 mm <sup>2</sup>
		Type of conductor and conductor cross-section AWG 16/7
	Evaluation	passed
Pull-out test	Standard	DIN EN 60999-1 section 9.5 / 12.00

### Technical data

Requirement		≥5 N
Conductor type	Type of conductor and conductor cross-section	AWG 28/1
	Type of conductor and conductor cross-section	AWG 28/19
Evaluation		passed
Requirement		≥10 N
Conductor type	Type of conductor and conductor cross-section	2 × AWG 24/1
	Type of conductor and conductor cross-section	2 × AWG 24/19 with wire end ferrule
Evaluation		passed
Requirement		≥40 N
Conductor type	Type of conductor and conductor cross-section	H05V-U1.5
	Type of conductor and conductor cross-section	H05V-K1.5
	Type of conductor and conductor cross-section	AWG 16/7
Evaluation		passed

### Important note

**IPC conformity** Conformity: The products are developed, manufactured and delivered according international recognized standards and norms and comply with the assured properties in the data sheet resp. fulfill decorative properties in accordance with IPC-A-610 "Class 2". Further claims on the products can be evaluated on request.

- Notes**
- Additional variants on request
  - Gold-plated contact surfaces on request
  - Max. outer diameter of the conductor: 2.9 mm
  - Max. outer diameter of the conductor: 2.9 mm
  - Wire end ferrule without plastic collar to DIN 46228/1
  - Wire end ferrule with plastic collar to DIN 46228/4
  - P on drawing = pitch
  - Rated data refer only to the component itself. Clearance and creepage distances to other components are to be designed in accordance with the relevant application standards.
  - In accordance with IEC 61984, OMNIMATE-connectors are connectors without breaking capacity (COC). During designated use, connectors are not allowed to be engaged or disengaged when live or under load
  - Long term storage of the product with average temperature of 50 °C and maximum humidity 70%, 36 months

### Classifications

ETIM 8.0	EC002638	ETIM 9.0	EC002638
ETIM 10.0	EC002638	ECLASS 14.0	27-46-02-02
ECLASS 15.0	27-46-02-02		

## BL 3.50/24/90F SN OR BX

**Weidmüller Interface GmbH & Co. KG**  
 Klingenbergstraße 26  
 D-32758 Detmold  
 Germany

www.weidmueller.com

# Drawings

### Product image

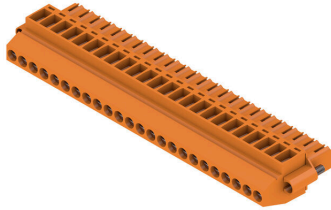

### Dimensional drawing

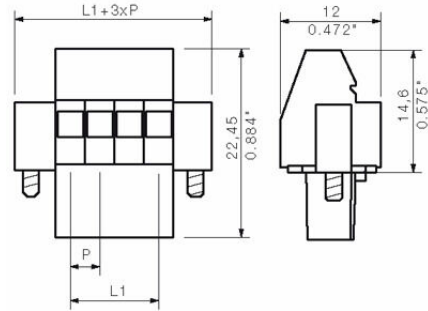

### Graph

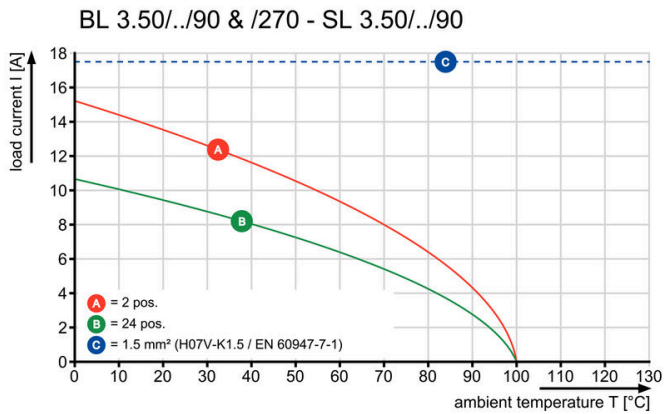

### Graph

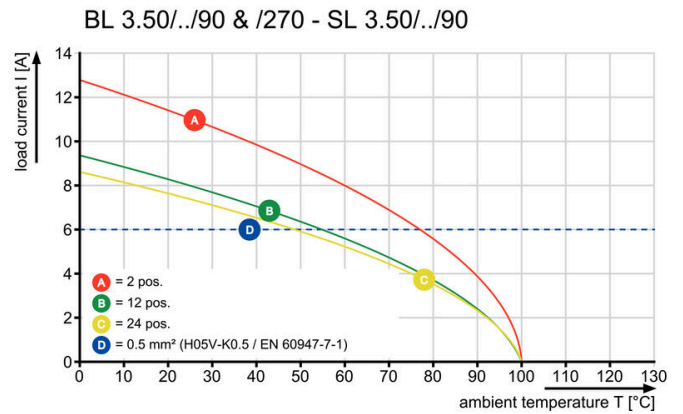

## BL 3.50/24/90F SN OR BX

**Weidmüller Interface GmbH & Co. KG**  
 Klingenbergstraße 26  
 D-32758 Detmold  
 Germany

www.weidmueller.com

## Accessories

### Coding elements



Only connects what is supposed to be connected: the right connection at the right place.  
 Coding elements and locking devices clearly assign connecting elements during the manufacturing process and operation  
 The coding elements and locking devices are inserted prior to assembly or during the cable assembly phase.  
 The Weidmüller alternative: configure online using the variant configurator to precode prior to delivery.  
 Incorrect assembly on the circuit board and incorrect plugging of connecting elements is no longer possible.  
 The advantage: no troubleshooting during manufacture and no operational errors by the user.

### General ordering data

Type	BL SL 3.5 KO OR	Version
Order No.	<a href="#">1693430000</a>	PCB plug-in connector, Accessories, Coding element, orange, Number
GTIN (EAN)	4008190867447	of poles: 1
Qty.	100 ST	
Type	BL SL 3.5 KO SW	Version
Order No.	<a href="#">1610100000</a>	PCB plug-in connector, Accessories, Coding element, black, Number
GTIN (EAN)	4008190187637	of poles: 1
Qty.	100 ST	



## BL 3.50/24/90F SN OR BX

**Weidmüller Interface GmbH & Co. KG**  
 Klingenbergstraße 26  
 D-32758 Detmold  
 Germany

www.weidmueller.com

## Counterpart

## SL 3.50/180G

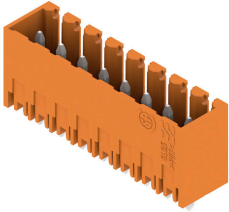

- Pin headers for wave soldering in 3.50 mm pitch
- Plugging direction is parallel (90°), straight 180° or angled (135°) to the PCB
  - Housing variant: screw flange (F)
  - Packed in a cardboard box (BX)
  - Pin header can be coded

## General ordering data

Type	SL 3.50/24/180G 4.5SN B...	Version
Order No.	<a href="#">1618680000</a>	PCB plug-in connector, male header, closed side, THT solder
GTIN (EAN)	4008190126384	connection, 3.50 mm, Number of poles: 24, 180°, Solder pin length
Qty.	20 ST	(l): 4.5 mm, tinned, black, Box

## SL 3.50/90

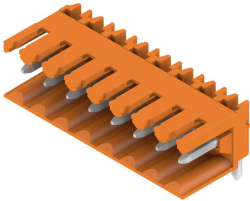

- Pin headers for wave soldering in 3.50 mm pitch
- Plugging direction is parallel (90°), straight 180° or angled (135°) to the PCB
  - Housing variant: screw flange (F)
  - Packed in a cardboard box (BX)
  - Pin header can be coded

## General ordering data

Type	SL 3.50/24/90 3.2SN OR ...	Version
Order No.	<a href="#">1619060000</a>	PCB plug-in connector, male header, open side, THT solder
GTIN (EAN)	4008190133047	connection, 3.50 mm, Number of poles: 24, 90°, Solder pin length (l):
Qty.	20 ST	3.2 mm, tinned, orange, Box

## SL 3.50/90G

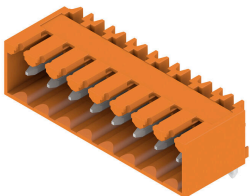

- Pin headers for wave soldering in 3.50 mm pitch
- Plugging direction is parallel (90°), straight 180° or angled (135°) to the PCB
  - Housing variant: screw flange (F)
  - Packed in a cardboard box (BX)
  - Pin header can be coded

## General ordering data

Type	SL 3.50/24/90G 3.2SN OR...	Version
Order No.	<a href="#">1619450000</a>	PCB plug-in connector, male header, closed side, THT solder
GTIN (EAN)	4008190140137	connection, 3.50 mm, Number of poles: 24, 90°, Solder pin length (l):
Qty.	20 ST	3.2 mm, tinned, orange, Box

## BL 3.50/24/90F SN OR BX

**Weidmüller Interface GmbH & Co. KG**  
 Klingenbergstraße 26  
 D-32758 Detmold  
 Germany

## Counterpart

www.weidmueller.com

## SL 3.50/180

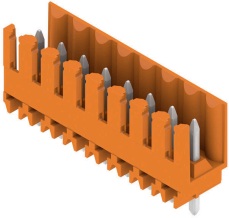

Pin headers for wave soldering in 3.50 mm pitch

- Plugging direction is parallel (90°), straight 180° or angled (135°) to the PCB
- Housing variant: screw flange (F)
- Packed in a cardboard box (BX)
- Pin header can be coded

## General ordering data

Type	SL 3.50/24/180 3.2SN OR...	Version
Order No.	<a href="#">1621470000</a>	PCB plug-in connector, male header, open side, THT solder
GTIN (EAN)	4008190173890	connection, 3.50 mm, Number of poles: 24, 180°, Solder pin length
Qty.	20 ST	(l): 3.2 mm, tinned, orange, Box

## SL 3.50/180G

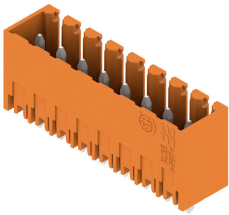

Pin headers for wave soldering in 3.50 mm pitch

- Plugging direction is parallel (90°), straight 180° or angled (135°) to the PCB
- Housing variant: screw flange (F)
- Packed in a cardboard box (BX)
- Pin header can be coded

## General ordering data

Type	SL 3.50/24/180G 3.2SN O...	Version
Order No.	<a href="#">1621860000</a>	PCB plug-in connector, male header, closed side, THT solder
GTIN (EAN)	4008190182076	connection, 3.50 mm, Number of poles: 24, 180°, Solder pin length
Qty.	20 ST	(l): 3.2 mm, tinned, orange, Box

## SLD 3.50/90

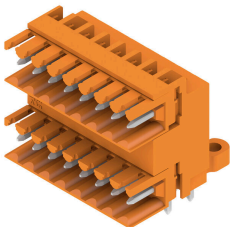

Two-tier pin header for wave soldering in 3.50 mm pitch. The connector is available in open, closed and flange versions. The male connectors provide space for labelling and can be coded. Packed in a cardboard box.

## General ordering data

Type	SLD 3.50/48/90 3.2SN OR...	Version
Order No.	<a href="#">1633570000</a>	PCB plug-in connector, male header, open side, THT solder
GTIN (EAN)	4008190258023	connection, 3.50 mm, Number of poles: 48, 90°, Solder pin length (l):
Qty.	10 ST	3.2 mm, tinned, orange, Box

## BL 3.50/24/90F SN OR BX

**Weidmüller Interface GmbH & Co. KG**  
 Klingenbergstraße 26  
 D-32758 Detmold  
 Germany

## Counterpart

www.weidmueller.com

## SLD 3.50/90G

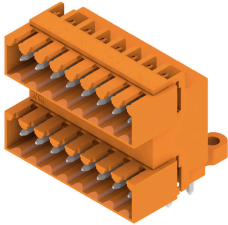

Two-tier pin header for wave soldering in 3.50 mm pitch. The connector is available in open, closed and flange versions. The male connectors provide space for labelling and can be coded. Packed in a cardboard box.

## General ordering data

Type	SLD 3.50/48/90G 3.2SN O...	Version
Order No.	<a href="#">1633800000</a>	PCB plug-in connector, male header, closed side, THT solder
GTIN (EAN)	4008190258252	connection, 3.50 mm, Number of poles: 48, 90°, Solder pin length (l):
Qty.	10 ST	3.2 mm, tinned, orange, Box

## SLD 3.50V/180G

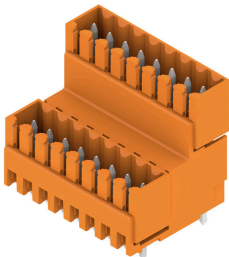

Double-level, staggered pin header for wave soldering at 3.50 mm pitch. They are available in closed and flanged versions. The male connectors provide space for labelling and can be coded.

## General ordering data

Type	SLD 3.50V/48/180G 3.2SN...	Version
Order No.	<a href="#">1641220000</a>	PCB plug-in connector, male header, closed side, THT solder
GTIN (EAN)	4008190279622	connection, 3.50 mm, Number of poles: 48, 180°, Solder pin length
Qty.	10 ST	(l): 3.2 mm, tinned, orange, Box

## SLD 3.50V/90G

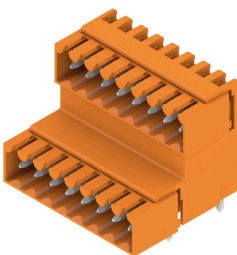

Double-level, staggered pin header for wave soldering at 3.50 mm pitch. They are available in closed and flanged versions. The male connectors provide space for labelling and can be coded.

## General ordering data

Type	SLD 3.50V/48/90G 3.2SN ...	Version
Order No.	<a href="#">1642350000</a>	PCB plug-in connector, male header, closed side, THT solder
GTIN (EAN)	4008190280871	connection, 3.50 mm, Number of poles: 48, 90°, Solder pin length (l):
Qty.	10 ST	3.2 mm, tinned, orange, Box

## BL 3.50/24/90F SN OR BX

**Weidmüller Interface GmbH & Co. KG**  
 Klingenbergstraße 26  
 D-32758 Detmold  
 Germany

www.weidmueller.com

## Counterpart

## SL-SMT 3.5/180G Box



- High-temperature-resistant male header, 3.50 mm pitch.
- Plugging direction parallel (90°), straight 180° or angled (135°) to PCB
  - Housing variants: closed side (G), screw flange (F), solder flange (LF) or snap-on solder flange (RF)
  - Optimised for the SMT process
  - Pin length 3.2 mm universal for all soldering methods
  - Pin length 1.5 mm optimised for reflow soldering methods
  - Packed either in a box (BX) or tape-on-reel (RL)
  - Male header can be coded

## General ordering data

Type	SL-SMT 3.50/24/180G 1.5...	Version
Order No.	<a href="#">1753202001</a>	PCB plug-in connector, male header, closed side, THT/THR solder
GTIN (EAN)	4032248131105	connection, 3.50 mm, Number of poles: 24, 180°, Solder pin length
Qty.	20 ST	(l): 1.5 mm, tinned, black, Box

## SL-SMT 3.5/90G Box



- High-temperature-resistant male header, 3.50 mm pitch.
- Plugging direction parallel (90°), straight 180° or angled (135°) to PCB
  - Housing variants: closed side (G), screw flange (F), solder flange (LF) or snap-on solder flange (RF)
  - Optimised for the SMT process
  - Pin length 3.2 mm universal for all soldering methods
  - Pin length 1.5 mm optimised for reflow soldering methods
  - Packed either in a box (BX) or tape-on-reel (RL)
  - Male header can be coded

## General ordering data

Type	SL-SMT 3.50/24/90G 1.5S...	Version
Order No.	<a href="#">1761762001</a>	PCB plug-in connector, male header, closed side, THT/THR solder
GTIN (EAN)	4032248132355	connection, 3.50 mm, Number of poles: 24, 90°, Solder pin length (l):
Qty.	20 ST	1.5 mm, tinned, black, Box
Type	SL-SMT 3.50/24/90G 3.2S...	Version
Order No.	<a href="#">1841850000</a>	PCB plug-in connector, male header, closed side, THT/THR solder
GTIN (EAN)	4032248353200	connection, 3.50 mm, Number of poles: 24, 90°, Solder pin length (l):
Qty.	20 ST	3.2 mm, tinned, black, Box

## BL 3.50/24/90F SN OR BX

**Weidmüller Interface GmbH & Co. KG**  
 Klingenbergstraße 26  
 D-32758 Detmold  
 Germany

www.weidmueller.com

## Counterpart

## SL-SMT 3.5/180G Box



- High-temperature-resistant male header, 3.50 mm pitch.
- Plugging direction parallel (90°), straight 180° or angled (135°) to PCB
  - Housing variants: closed side (G), screw flange (F), solder flange (LF) or snap-on solder flange (RF)
  - Optimised for the SMT process
  - Pin length 3.2 mm universal for all soldering methods
  - Pin length 1.5 mm optimised for reflow soldering methods
  - Packed either in a box (BX) or tape-on-reel (RL)
  - Male header can be coded

## General ordering data

Type	SL-SMT 3.50/24/180G 3.2...	Version
Order No.	<a href="#">1842530000</a>	PCB plug-in connector, male header, closed side, THT/THR solder
GTIN (EAN)	4032248353897	connection, 3.50 mm, Number of poles: 24, 180°, Solder pin length
Qty.	20 ST	(l): 3.2 mm, tinned, black, Box

## SL-THR 3.5/135F

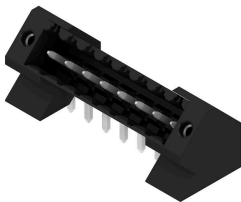

- High-temperature-resistant male header, 3.50 mm pitch.
- Plugging direction parallel (90°), straight 180° or angled (135°) to PCB
  - Housing variants: closed side (G), screw flange (F), solder flange (LF) or snap-on solder flange (RF)
  - Optimised for the SMT process
  - Pin length 3.2 mm universal for all soldering methods
  - Pin length 1.5 mm optimised for reflow soldering methods
  - Packed either in a box (BX) or tape-on-reel (RL)
  - Male header can be coded

## General ordering data

Type	SL-SMT 3.50/24/135F 3.2...	Version
Order No.	<a href="#">1003740000</a>	PCB plug-in connector, male header, Flange, THT/THR solder
GTIN (EAN)	4032248700363	connection, 3.50 mm, Number of poles: 24, 135°, Solder pin length
Qty.	18 ST	(l): 3.2 mm, tinned, black, Box

## SL 3.50/180F

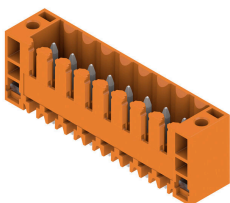

- Pin headers for wave soldering in 3.50 mm pitch
- Plugging direction is parallel (90°), straight 180° or angled (135°) to the PCB
  - Housing variant: screw flange (F)
  - Packed in a cardboard box (BX)
  - Pin header can be coded

## BL 3.50/24/90F SN OR BX

**Weidmüller Interface GmbH & Co. KG**  
 Klingenbergstraße 26  
 D-32758 Detmold  
 Germany

www.weidmueller.com

## Counterpart

## General ordering data

Type	SL 3.50/24/180F 4.5 SN ...	Version
Order No.	<a href="#">1618980000</a>	PCB plug-in connector, male header, Flange, THT solder connection,
GTIN (EAN)	4008190131418	3.50 mm, Number of poles: 24, 180°, Solder pin length (l): 4.5 mm,
Qty.	20 ST	tinned, black, Box

## SL 3.50/90F

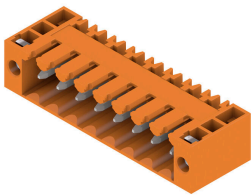

Pin headers for wave soldering in 3.50 mm pitch

- Plugging direction is parallel (90°), straight 180° or angled (135°) to the PCB
- Housing variant: screw flange (F)
- Packed in a cardboard box (BX)
- Pin header can be coded

## General ordering data

Type	SL 3.50/24/90F 3.2SN OR...	Version
Order No.	<a href="#">1619840000</a>	PCB plug-in connector, male header, Flange, THT solder connection,
GTIN (EAN)	4008190147679	3.50 mm, Number of poles: 24, 90°, Solder pin length (l): 3.2 mm,
Qty.	20 ST	tinned, orange, Box
Type	SL 3.50/24/90F 3.2SN DK...	Version
Order No.	<a href="#">1620280000</a>	PCB plug-in connector, male header, Flange, THT solder connection,
GTIN (EAN)	4008190154004	3.50 mm, Number of poles: 24, 90°, Solder pin length (l): 3.2 mm,
Qty.	20 ST	tinned, Signal green, Box

## SL 3.50/180F

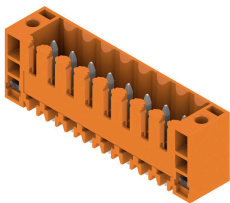

Pin headers for wave soldering in 3.50 mm pitch

- Plugging direction is parallel (90°), straight 180° or angled (135°) to the PCB
- Housing variant: screw flange (F)
- Packed in a cardboard box (BX)
- Pin header can be coded

## General ordering data

Type	SL 3.50/24/180F 3.2SN O...	Version
Order No.	<a href="#">1622250000</a>	PCB plug-in connector, male header, Flange, THT solder connection,
GTIN (EAN)	4008190189723	3.50 mm, Number of poles: 24, 180°, Solder pin length (l): 3.2 mm,
Qty.	20 ST	tinned, orange, Box

## BL 3.50/24/90F SN OR BX

**Weidmüller Interface GmbH & Co. KG**  
 Klingenbergstraße 26  
 D-32758 Detmold  
 Germany

## Counterpart

www.weidmueller.com

## SLD 3.50/90F

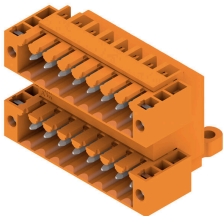

Two-tier pin header for wave soldering in 3.50 mm pitch. The connector is available in open, closed and flange versions. The male connectors provide space for labelling and can be coded. Packed in a cardboard box.

## General ordering data

Type	SLD 3.50/48/90F 3.2SN O...	Version
Order No.	<a href="#">1634030000</a>	PCB plug-in connector, male header, Flange, THT solder connection,
GTIN (EAN)	4008190258481	3.50 mm, Number of poles: 48, 90°, Solder pin length (l): 3.2 mm,
Qty.	10 ST	tinned, orange, Box

## SLD 3.50V/180F

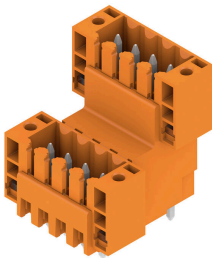

Double-level, staggered pin header for wave soldering at 3.50 mm pitch. They are available in closed and flanged versions. The male connectors provide space for labelling and can be coded.

## General ordering data

Type	SLD 3.50 V/48/180F 3.2 ...	Version
Order No.	<a href="#">1641350000</a>	PCB plug-in connector, male header, Flange, THT solder connection,
GTIN (EAN)	4008190279752	3.50 mm, Number of poles: 48, 180°, Solder pin length (l): 3.2 mm,
Qty.	10 ST	tinned, orange, Box

## SLD 3.50V/90F

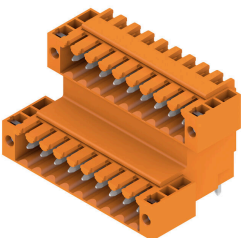

Double-level, staggered pin header for wave soldering at 3.50 mm pitch. They are available in closed and flanged versions. The male connectors provide space for labelling and can be coded.

## General ordering data

Type	SLD 3.50 V/48/90F 3.2 S...	Version
Order No.	<a href="#">1642480000</a>	PCB plug-in connector, male header, Flange, THT solder connection,
GTIN (EAN)	4008190281007	3.50 mm, Number of poles: 48, 90°, Solder pin length (l): 3.2 mm,
Qty.	10 ST	tinned, orange, Box

## BL 3.50/24/90F SN OR BX

**Weidmüller Interface GmbH & Co. KG**  
 Klingenbergstraße 26  
 D-32758 Detmold  
 Germany

www.weidmueller.com

## Counterpart

Type	SLD 3.50 V/48/90F 4.5 S...	Version
Order No.	<a href="#">1643210000</a>	PCB plug-in connector, male header, Flange, THT solder connection,
GTIN (EAN)	4008190281809	3.50 mm, Number of poles: 48, 90°, Solder pin length (l): 4.5 mm,
Qty.	10 ST	tinned, black, Box

## SL 3.50/135F

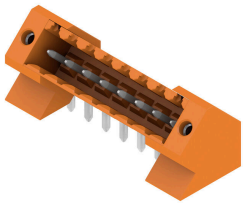

Pin headers for wave soldering in 3.50 mm pitch

- Plugging direction is parallel (90°), straight 180° or angled (135°) to the PCB
- Housing variant: screw flange (F)
- Packed in a cardboard box (BX)
- Pin header can be coded

### General ordering data

Type	SL 3.50/24/135F 3.2SN O...	Version
Order No.	<a href="#">1643550000</a>	PCB plug-in connector, male header, Flange, THT solder connection,
GTIN (EAN)	4008190282318	3.50 mm, Number of poles: 24, 135°, Solder pin length (l): 3.2 mm,
Qty.	18 ST	tinned, orange, Box

## SL-SMT 3.5/90F Box



High-temperature-resistant male header, 3.50 mm pitch.

- Plugging direction parallel (90°), straight 180° or angled (135°) to PCB
- Housing variants: closed side (G), screw flange (F), solder flange (LF) or snap-on solder flange (RF)
- Optimised for the SMT process
- Pin length 3.2 mm universal for all soldering methods
- Pin length 1.5 mm optimised for reflow soldering methods
- Packed either in a box (BX) or tape-on-reel (RL)
- Male header can be coded

### General ordering data

Type	SL-SMT 3.50/24/90F 1.5S...	Version
Order No.	<a href="#">1762222001</a>	PCB plug-in connector, male header, Flange, THT/THR solder
GTIN (EAN)	4032248132638	connection, 3.50 mm, Number of poles: 24, 90°, Solder pin length (l):
Qty.	20 ST	1.5 mm, tinned, black, Box



## BL 3.50/24/90F SN OR BX

Weidmüller Interface GmbH &amp; Co. KG

Klingenbergstraße 26

D-32758 Detmold

Germany

www.weidmueller.com

## Counterpart

## SL-SMT 3.5/180LF Box

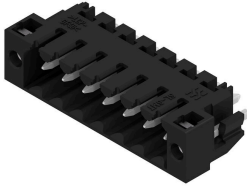

High-temperature-resistant male header, 3.50 mm pitch.

- Plugging direction parallel (90°), straight 180° or angled (135°) to PCB
- Housing variants: closed side (G), screw flange (F), solder flange (LF) or snap-on solder flange (RF)
- Optimised for the SMT process
- Pin length 3.2 mm universal for all soldering methods
- Pin length 1.5 mm optimised for reflow soldering methods
- Packed either in a box (BX) or tape-on-reel (RL)
- Male header can be coded

## General ordering data

Type	SL-SMT 3.50/24/180LF 1...	Version
Order No.	<a href="#">1804930000</a>	PCB plug-in connector, male header, Solder flange, THT/THR solder
GTIN (EAN)	4032248268696	connection, 3.50 mm, Number of poles: 24, 180°, Solder pin length
Qty.	18 ST	(l): 1.5 mm, tinned, black, Box

## SL-SMT 3.5/90LF Box



High-temperature-resistant male header, 3.50 mm pitch.

- Plugging direction parallel (90°), straight 180° or angled (135°) to PCB
- Housing variants: closed side (G), screw flange (F), solder flange (LF) or snap-on solder flange (RF)
- Optimised for the SMT process
- Pin length 3.2 mm universal for all soldering methods
- Pin length 1.5 mm optimised for reflow soldering methods
- Packed either in a box (BX) or tape-on-reel (RL)
- Male header can be coded

## General ordering data

Type	SL-SMT 3.50/24/90LF 1.5...	Version
Order No.	<a href="#">1805160000</a>	PCB plug-in connector, male header, Solder flange, THT/THR solder
GTIN (EAN)	4032248269068	connection, 3.50 mm, Number of poles: 24, 90°, Solder pin length (l):
Qty.	18 ST	1.5 mm, tinned, black, Box
Type	SL-SMT 3.50/24/90LF 3.2...	Version
Order No.	<a href="#">1842070000</a>	PCB plug-in connector, male header, Solder flange, THT/THR solder
GTIN (EAN)	4032248353422	connection, 3.50 mm, Number of poles: 24, 90°, Solder pin length (l):
Qty.	18 ST	3.2 mm, tinned, black, Box

## BL 3.50/24/90F SN OR BX

**Weidmüller Interface GmbH & Co. KG**  
 Klingenbergstraße 26  
 D-32758 Detmold  
 Germany

www.weidmueller.com

## Counterpart

## SL-SMT 3.5/180LF Box

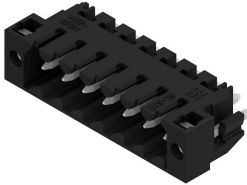

- High-temperature-resistant male header, 3.50 mm pitch.
- Plugging direction parallel (90°), straight 180° or angled (135°) to PCB
  - Housing variants: closed side (G), screw flange (F), solder flange (LF) or snap-on solder flange (RF)
  - Optimised for the SMT process
  - Pin length 3.2 mm universal for all soldering methods
  - Pin length 1.5 mm optimised for reflow soldering methods
  - Packed either in a box (BX) or tape-on-reel (RL)
  - Male header can be coded

## General ordering data

Type	SL-SMT 3.50/24/180LF 3...	Version
Order No.	<a href="#">1842760000</a>	PCB plug-in connector, male header, Solder flange, THT/THR solder
GTIN (EAN)	4032248354122	connection, 3.50 mm, Number of poles: 24, 180°, Solder pin length
Qty.	18 ST	(l): 3.2 mm, tinned, black, Box

## SL-SMT 3.5/90F Box

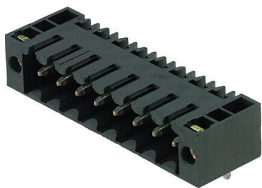

- High-temperature-resistant male header, 3.50 mm pitch.
- Plugging direction parallel (90°), straight 180° or angled (135°) to PCB
  - Housing variants: closed side (G), screw flange (F), solder flange (LF) or snap-on solder flange (RF)
  - Optimised for the SMT process
  - Pin length 3.2 mm universal for all soldering methods
  - Pin length 1.5 mm optimised for reflow soldering methods
  - Packed either in a box (BX) or tape-on-reel (RL)
  - Male header can be coded

## General ordering data

Type	SL-SMT 3.50/24/90F 3.2S...	Version
Order No.	<a href="#">1842300000</a>	PCB plug-in connector, male header, Flange, THT/THR solder
GTIN (EAN)	4032248353651	connection, 3.50 mm, Number of poles: 24, 90°, Solder pin length (l):
Qty.	18 ST	3.2 mm, tinned, black, Box

## SL-SMT 3.5/180F Box



- High-temperature-resistant male header, 3.50 mm pitch.
- Plugging direction parallel (90°), straight 180° or angled (135°) to PCB
  - Housing variants: closed side (G), screw flange (F), solder flange (LF) or snap-on solder flange (RF)
  - Optimised for the SMT process
  - Pin length 3.2 mm universal for all soldering methods
  - Pin length 1.5 mm optimised for reflow soldering methods
  - Packed either in a box (BX) or tape-on-reel (RL)
  - Male header can be coded

## BL 3.50/24/90F SN OR BX

**Weidmüller Interface GmbH & Co. KG**  
Klingenbergstraße 26  
D-32758 Detmold  
Germany

[www.weidmueller.com](http://www.weidmueller.com)

# Counterpart

### General ordering data

Type	SL-SMT 3.50/24/180F 3.2...	Version
Order No.	<a href="#">1842990000</a>	PCB plug-in connector, male header, Flange, THT/THR solder
GTIN (EAN)	4032248354450	connection, 3.50 mm, Number of poles: 24, 180°, Solder pin length
Qty.	18 ST	(!): 3.2 mm, tinned, black, Box