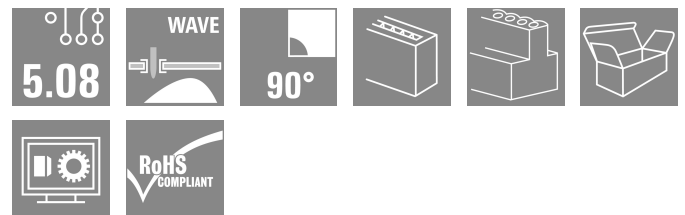
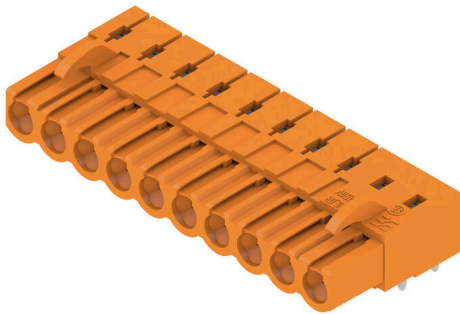

**BLL 5.08/10/90 3.2 SN OR BX**

**Weidmüller Interface GmbH & Co. KG**  
 Klingenbergstraße 26  
 D-32758 Detmold  
 Germany

www.weidmueller.com

**Product image**

Female header for PCB mounting. The solder pin length is optimised for wave flow soldering.

**General ordering data**

Version	PCB plug-in connector, female header, closed side, THT solder connection, 5.08 mm, Number of poles: 10, 90°, Solder pin length (l): 3.2 mm, tinned, orange, Box
Order No.	<a href="#">1623020000</a>
Type	BLL 5.08/10/90 3.2 SN OR BX
GTIN (EAN)	4008190194079
Qty.	36 items
Product data	IEC: 400 V / 23 A UL: 300 V / 15 A
Packaging	Box

## BLL 5.08/10/90 3.2 SN OR BX

**Weidmüller Interface GmbH & Co. KG**  
 Klingenbergstraße 26  
 D-32758 Detmold  
 Germany

www.weidmueller.com

## Technical data

### Approvals

Approvals



ROHS	Conform
UL File Number Search	<a href="#">UL Website</a>
Certificate No. (UR)	E60693

### Dimensions and weights

Net weight	10.33 g
------------	---------

### Environmental Product Compliance

RoHS Compliance Status	Compliant without exemption
REACH SVHC	No SVHC above 0.1 wt%

### System specifications

Product family	OMNIMATE Signal - series BL/SL 5.08	Type of connection	Board connection
Mounting onto the PCB	THT solder connection	Pitch in mm (P)	5.08 mm
Pitch in inches (P)	0.200 "	Outgoing elbow	90°
Number of poles	10	Number of solder pins per pole	2
Solder pin length (l)	3.2 mm	Solder pin length tolerance	+0.1 / -0.3 mm
Solder pin dimensions	0.4 x 1.00 mm	Solder eyelet hole diameter (D)	1.3 mm
Solder eyelet hole diameter tolerance (D)+ 0,1 mm		L1 in mm	45.72 mm
L1 in inches	1.800 "	Number of rows	1
Pin series quantity	1	Touch-safe protection acc. to DIN VDE 57 106	Safe from back-of-hand touch
Touch-safe protection acc. to DIN VDE 0470	IP20 plugged	Protection degree	IP20
Volume resistance	≤5 mΩ	Can be coded	Yes
Plugging cycles	25	Plugging force/pole, max.	5 N
Pulling force/pole, max.	5 N		

### Material data

Insulating material	PBT GF	Colour	orange
Colour chart (similar)	RAL 2000	Insulating material group	IIIa
Comparative Tracking Index (CTI)	≥ 200	Insulation resistance	108 Ω
Moisture Level (MSL)		UL 94 flammability rating	V-0
Contact material	Copper alloy	Contact surface	tinned
Layer structure of solder connection	4...6 μm Sn hot-dip tinned	Layer structure of plug contact	4...6 μm Sn hot-dip tinned
Storage temperature, min.	-40 °C	Storage temperature, max.	70 °C
Operating temperature, min.	-50 °C	Operating temperature, max.	100 °C
Temperature range, installation, min.	-25 °C	Temperature range, installation, max.	100 °C

### Rated data acc. to IEC

tested acc. to standard	IEC 60664-1, IEC 61984	Rated current, min. number of poles (Tu=20°C)	23 A
Rated current, max. number of poles (Tu=20°C)	16 A	Rated current, min. number of poles (Tu=40°C)	20 A

## BLL 5.08/10/90 3.2 SN OR BX

**Weidmüller Interface GmbH & Co. KG**  
 Klingenbergstraße 26  
 D-32758 Detmold  
 Germany

www.weidmueller.com

## Technical data

Rated current, max. number of poles (Tu=40°C)	14 A	Rated voltage for surge voltage class / pollution degree II/2	400 V
Rated voltage for surge voltage class / pollution degree III/2	320 V	Rated voltage for surge voltage class / pollution degree III/3	250 V
Rated impulse voltage for surge voltage class/ pollution degree II/2	4 V	Rated impulse voltage for surge voltage class/ pollution degree III/2	4 kV
Rated impulse voltage for surge voltage class/ contamination degree III/3	4 kV	Short-time withstand current resistance	3 x 1s with 120 A

### Rated data acc. to CSA

Institute (CSA)	CSA	Certificate No. (CSA)	200039-1121690
Rated voltage (Use group B / CSA)	300 V	Rated voltage (Use group D / CSA)	300 V
Rated current (Use group B / CSA)	15 A	Rated current (Use group D / CSA)	10 A
Reference to approval values	Specifications are maximum values, details - see approval certificate.		

### Rated data acc. to UL 1059

Institute (UR)	UR	Certificate No. (UR)	E60693
Rated voltage (Use group B / UL 1059)	300 V	Rated voltage (Use group D / UL 1059)	300 V
Rated current (Use group B / UL 1059)	15 A	Rated current (Use group D / UL 1059)	10 A
Reference to approval values	Specifications are maximum values, details - see approval certificate.		

### Packing

Packaging	Box	VPE length	348.00 mm
VPE width	136.00 mm	VPE height	31.00 mm

### Important note

IPC conformity  
 Conformity: The products are developed, manufactured and delivered according international recognized standards and norms and comply with the assured properties in the data sheet resp. fulfill decorative properties in accordance with IPC-A-610 "Class 2". Further claims on the products can be evaluated on request.

- Notes
- Additional variants on request
  - Gold-plated contact surfaces on request
  - Rated current related to rated cross-section & min. No. of poles.
  - P on drawing = pitch
  - Rated data refer only to the component itself. Clearance and creepage distances to other components are to be designed in accordance with the relevant application standards.
  - In accordance with IEC 61984, OMNIMATE-connectors are connectors without breaking capacity (COC). During designated use, connectors are not allowed to be engaged or disengaged when live or under load
  - Long term storage of the product with average temperature of 50 °C and maximum humidity 70%, 36 months

### Classifications

ETIM 8.0	EC002637	ETIM 9.0	EC002637
ETIM 10.0	EC002637	ECLASS 14.0	27-46-02-01
ECLASS 15.0	27-46-02-01		

Product image

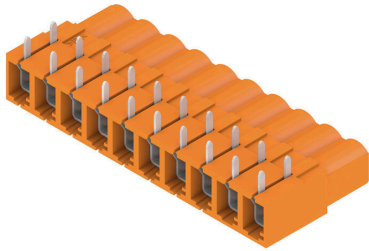

Dimensional drawing

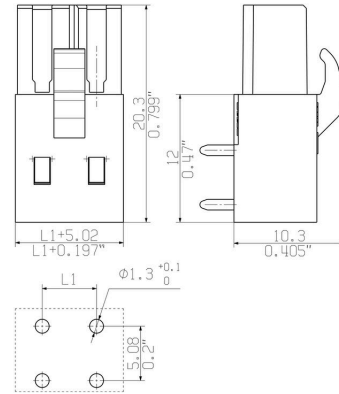

Example of use

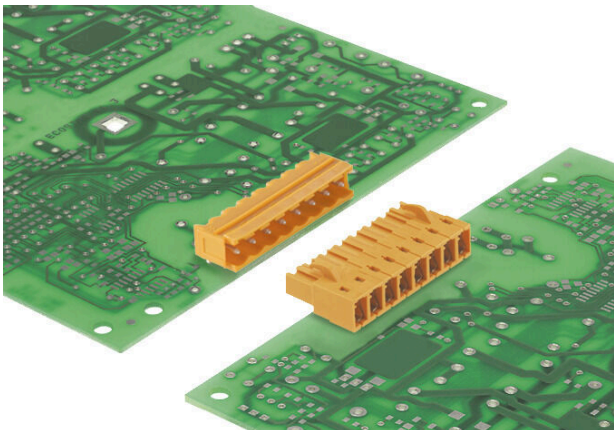

### Coding elements



Only connects what is supposed to be connected: the right connection at the right place.  
 Coding elements and locking devices clearly assign connecting elements during the manufacturing process and operation  
 The coding elements and locking devices are inserted prior to assembly or during the cable assembly phase. The Weidmüller alternative: configure online using the variant configurator to precode prior to delivery. Incorrect assembly on the circuit board and incorrect plugging of connecting elements is no longer possible. The advantage: no troubleshooting during manufacture and no operational errors by the user.

### General ordering data

Type	BLZ/SL KO BK BX	Version
Order No.	<a href="#">1545710000</a>	PCB plug-in connector, Accessories, Coding element, black, Number
GTIN (EAN)	4008190087142	of poles: 1
Qty.	50 ST	
Type	BLZ/SL KO OR BX	Version
Order No.	<a href="#">1573010000</a>	PCB plug-in connector, Accessories, Coding element, orange, Number
GTIN (EAN)	4008190048396	of poles: 1
Qty.	100 ST	

## BLL 5.08/10/90 3.2 SN OR BX

**Weidmüller Interface GmbH & Co. KG**  
 Klingenbergstraße 26  
 D-32758 Detmold  
 Germany

www.weidmueller.com

## Counterpart

## SLDF 5.08

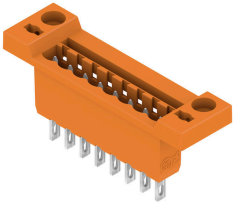

Male connector for through-panel mounting with optional locking function. Internal connection as flat-blade or solder connection. These male connectors provide space for labelling and can be coded.

## General ordering data

Type	SLDF 5.08 L/F 10 SN OR ...	Version
Order No.	<a href="#">1599210000</a>	PCB plug-in connector, male header, 5.08 mm, Number of poles: 10,
GTIN (EAN)	4008190065522	180°, Flat-blade connection, Solder connection, Box
Qty.	24 ST	

## SL 5.08/135



Male connectors with 135° outlet direction. The solder pin length is optimised for wave flow soldering. The pin headers provide space for labelling and can be coded.

## General ordering data

Type	SL 5.08/10/135 3.2SN OR...	Version
Order No.	<a href="#">1603140000</a>	PCB plug-in connector, male header, open side, THT solder
GTIN (EAN)	4008190082123	connection, 5.08 mm, Number of poles: 10, 135°, Solder pin length
Qty.	50 ST	(l): 3.2 mm, tinned, orange, Box

## SL 5.08/135B

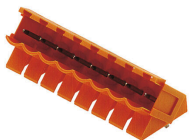

Male connectors with 135° outlet direction. The solder pin length is optimised for wave flow soldering. The pin headers provide space for labelling and can be coded.

## General ordering data

Type	SL 5.08/10/135B 3.2SN O...	Version
Order No.	<a href="#">1605610000</a>	PCB plug-in connector, male header, Dovetails for fixing blocks, THT
GTIN (EAN)	4008190178284	solder connection, 5.08 mm, Number of poles: 10, 135°, Solder pin
Qty.	50 ST	length (l): 3.2 mm, tinned, orange, Box

## BLL 5.08/10/90 3.2 SN OR BX

**Weidmüller Interface GmbH & Co. KG**  
 Klingenbergstraße 26  
 D-32758 Detmold  
 Germany

www.weidmueller.com

## Counterpart

### SL 5.08/180

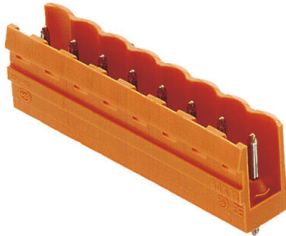

Male connectors with straight outlet direction. The solder pin length is optimised for wave flow soldering. The pin headers provide space for labelling and can be coded.

#### General ordering data

Type	SL 5.08/10/180 3.2SN OR...	Version
Order No.	<a href="#">1518060000</a>	PCB plug-in connector, male header, open side, THT solder
GTIN (EAN)	4008190122539	connection, 5.08 mm, Number of poles: 10, 180°, Solder pin length
Qty.	50 ST	(l): 3.2 mm, tinned, orange, Box

### SL 5.08/180B



Male connectors with straight outlet direction. The solder pin length is optimised for wave flow soldering. The pin headers provide space for labelling and can be coded.

#### General ordering data

Type	SL 5.08/10/180B 3.2SN O...	Version
Order No.	<a href="#">1520360000</a>	PCB plug-in connector, male header, Dovetails for fixing blocks, THT
GTIN (EAN)	4008190030612	solder connection, 5.08 mm, Number of poles: 10, 180°, Solder pin
Qty.	50 ST	length (l): 3.2 mm, tinned, orange, Box

### SL 5.08/90

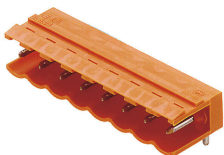

Male connectors with 90° outlet direction. The solder pin length is optimised for wave flow soldering. The pin headers provide space for labelling and can be coded.

#### General ordering data

Type	SL 5.08/10/90 3.2SN OR ...	Version
Order No.	<a href="#">1508860000</a>	PCB plug-in connector, male header, open side, THT solder
GTIN (EAN)	4008190089092	connection, 5.08 mm, Number of poles: 10, 90°, Solder pin length (l):
Qty.	50 ST	3.2 mm, tinned, orange, Box

## BLL 5.08/10/90 3.2 SN OR BX

**Weidmüller Interface GmbH & Co. KG**  
 Klingenbergstraße 26  
 D-32758 Detmold  
 Germany

www.weidmueller.com

## Counterpart

## SL 5.08/90B

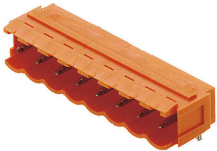

Male connectors with 90° outlet direction. The solder pin length is optimised for wave flow soldering. The pin headers provide space for labelling and can be coded.

## General ordering data

Type	SL 5.08/10/90B 3.2SN OR...	Version
Order No.	<a href="#">1511160000</a>	PCB plug-in connector, male header, Dovetails for fixing blocks, THT
GTIN (EAN)	4008190052485	solder connection, 5.08 mm, Number of poles: 10, 90°, Solder pin
Qty.	50 ST	length (l): 3.2 mm, tinned, orange, Box

## SL 5.08HC/180

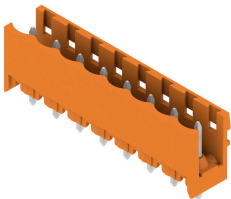

Pin headers in glass-fibre-reinforced plastic with straight wire outlet; optimised for wave soldering. The flange variant (F) can be screwed onto the respective counter piece or the circuit board. There is no need for an extra screw to connect the circuit board when the solder flange (LF) version is used. This also protects the solder points from mechanical strain. All pin headers can be manually coded or ordered pre-coded. HC = High Current.

## General ordering data

Type	SL 5.08HC/10/180 3.2SN ...	Version
Order No.	<a href="#">1148290000</a>	PCB plug-in connector, male header, open side, THT solder
GTIN (EAN)	4032248107773	connection, 5.08 mm, Number of poles: 10, 180°, Solder pin length
Qty.	50 ST	(l): 3.2 mm, tinned, black, Box
Type	SL 5.08HC/10/180 3.2SN ...	Version
Order No.	<a href="#">1146530000</a>	PCB plug-in connector, male header, open side, THT solder
GTIN (EAN)	4032248933310	connection, 5.08 mm, Number of poles: 10, 180°, Solder pin length
Qty.	50 ST	(l): 3.2 mm, tinned, orange, Box

## SL 5.08HC/180B

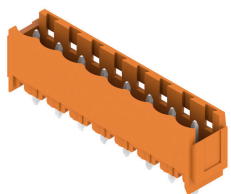

Pin headers in glass-fibre-reinforced plastic with straight wire outlet; optimised for wave soldering. The flange variant (F) can be screwed onto the respective counter piece or the circuit board. There is no need for an extra screw to connect the circuit board when the solder flange (LF) version is used. This also protects the solder points from mechanical strain. All pin headers can be manually coded or ordered pre-coded. HC = High Current.

## BLL 5.08/10/90 3.2 SN OR BX

**Weidmüller Interface GmbH & Co. KG**  
 Klingenbergstraße 26  
 D-32758 Detmold  
 Germany

www.weidmueller.com

## Counterpart

### General ordering data

Type	SL 5.08HC/10/180B 3.2SN...	Version
Order No.	<a href="#">1149670000</a>	PCB plug-in connector, male header, Dovetails for fixing blocks, THT
GTIN (EAN)	4032248934904	solder connection, 5.08 mm, Number of poles: 10, 180°, Solder pin
Qty.	50 ST	length (l): 3.2 mm, tinned, black, Box
Type	SL 5.08HC/10/180B 3.2SN...	Version
Order No.	<a href="#">1147580000</a>	PCB plug-in connector, male header, Dovetails for fixing blocks, THT
GTIN (EAN)	4032248934249	solder connection, 5.08 mm, Number of poles: 10, 180°, Solder pin
Qty.	50 ST	length (l): 3.2 mm, tinned, orange, Box

### SL 5.08HC/180G

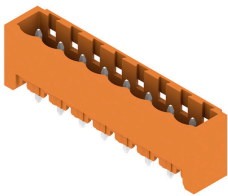

Pin headers in glass-fibre-reinforced plastic with straight wire outlet; optimised for wave soldering. The flange variant (F) can be screwed onto the respective counter piece or the circuit board. There is no need for an extra screw to connect the circuit board when the solder flange (LF) version is used. This also protects the solder points from mechanical strain. All pin headers can be manually coded or ordered pre-coded. HC = High Current.

### General ordering data

Type	SL 5.08HC/10/180G 3.2SN...	Version
Order No.	<a href="#">1148900000</a>	PCB plug-in connector, male header, closed side, THT solder
GTIN (EAN)	4032248935369	connection, 5.08 mm, Number of poles: 10, 180°, Solder pin length
Qty.	50 ST	(l): 3.2 mm, tinned, black, Box
Type	SL 5.08HC/10/180G 3.2SN...	Version
Order No.	<a href="#">1146910000</a>	PCB plug-in connector, male header, closed side, THT solder
GTIN (EAN)	4032248108602	connection, 5.08 mm, Number of poles: 10, 180°, Solder pin length
Qty.	50 ST	(l): 3.2 mm, tinned, orange, Box

### SL 5.08HC/90

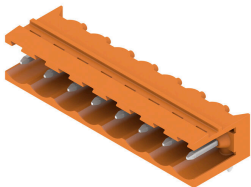

Pin headers made from glass-fibre-reinforced plastic with 90° wire outlet; optimised for wave soldering. The flange variant (F) can be screwed onto the respective counter piece or the circuit board. There is no need for an extra screw to connect the circuit board when the solder flange (LF) version is used. This also protects the solder points from mechanical strain. All pin headers can be manually coded or ordered pre-coded. HC = High Current.

### General ordering data

Type	SL 5.08HC/10/90 3.2SN B...	Version
Order No.	<a href="#">1155130000</a>	PCB plug-in connector, male header, open side, THT solder
GTIN (EAN)	4050118050738	connection, 5.08 mm, Number of poles: 10, 90°, Solder pin length (l):
Qty.	50 ST	3.2 mm, tinned, black, Box
Type	SL 5.08HC/10/90 3.2SN O...	Version
Order No.	<a href="#">1146900000</a>	PCB plug-in connector, male header, open side, THT solder
GTIN (EAN)	4050118051421	connection, 5.08 mm, Number of poles: 10, 90°, Solder pin length (l):
Qty.	50 ST	3.2 mm, tinned, orange, Box

## BLL 5.08/10/90 3.2 SN OR BX

**Weidmüller Interface GmbH & Co. KG**  
Klingenbergstraße 26  
D-32758 Detmold  
Germany

## Counterpart

www.weidmueller.com

### SL 5.08HC/90B

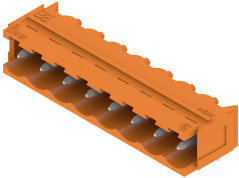

Pin headers made from glass-fibre-reinforced plastic with 90° wire outlet; optimised for wave soldering. The flange variant (F) can be screwed onto the respective counter piece or the circuit board. There is no need for an extra screw to connect the circuit board when the solder flange (LF) version is used. This also protects the solder points from mechanical strain. All pin headers can be manually coded or ordered pre-coded. HC = High Current.

#### General ordering data

Type	SL 5.08HC/10/90B 3.2SN ...	Version
Order No.	<a href="#">1155670000</a>	PCB plug-in connector, male header, Dovetails for fixing blocks, THT
GTIN (EAN)	4050118050271	solder connection, 5.08 mm, Number of poles: 10, 90°, Solder pin
Qty.	50 ST	length (l): 3.2 mm, tinned, black, Box
Type	SL 5.08HC/10/90B 3.2SN ...	Version
Order No.	<a href="#">1154850000</a>	PCB plug-in connector, male header, Dovetails for fixing blocks, THT
GTIN (EAN)	4050118050967	solder connection, 5.08 mm, Number of poles: 10, 90°, Solder pin
Qty.	50 ST	length (l): 3.2 mm, tinned, orange, Box

### SLDV 5.08/180

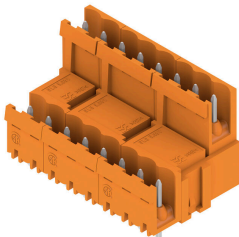

Pin headers with solder pin length optimised for wave flow soldering. The male connectors provide space for labelling and can be coded. HC = High Current.

#### General ordering data

Type	SLD 5.08V/20/180 3.2SN ...	Version
Order No.	<a href="#">1725730000</a>	PCB plug-in connector, male header, open side, THT solder
GTIN (EAN)	4032248062027	connection, 5.08 mm, Number of poles: 20, 180°, Solder pin length
Qty.	20 ST	(l): 3.2 mm, tinned, orange, Box

### SLDV 5.08/180B

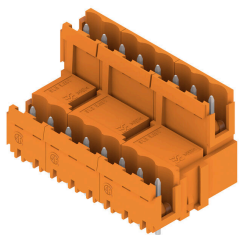

Pin headers with solder pin length optimised for wave flow soldering. The male connectors provide space for labelling and can be coded. HC = High Current.

## BLL 5.08/10/90 3.2 SN OR BX

**Weidmüller Interface GmbH & Co. KG**  
 Klingenbergstraße 26  
 D-32758 Detmold  
 Germany

## Counterpart

www.weidmuller.com

### General ordering data

Type	SLD 5.08V/20/180B 3.2SN...	Version
Order No.	<a href="#">1726820000</a>	PCB plug-in connector, male header, Dovetails for fixing blocks, THT
GTIN (EAN)	4032248062706	solder connection, 5.08 mm, Number of poles: 20, 180°, Solder pin
Qty.	20 ST	length (l): 3.2 mm, tinned, orange, Box

### SLDV 5.08/90

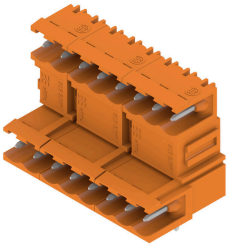

Pin headers with solder pin length optimised for wave flow soldering. The male connectors provide space for labelling and can be coded. HC = High Current.

### General ordering data

Type	SLD 5.08V/20/90 3.2 SN ...	Version
Order No.	<a href="#">1725250000</a>	PCB plug-in connector, male header, open side, THT solder
GTIN (EAN)	4032248060658	connection, 5.08 mm, Number of poles: 20, 90°, Solder pin length (l):
Qty.	20 ST	3.2 mm, tinned, orange, Box

### SLDV 5.08/90B

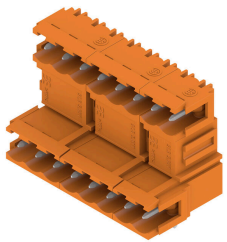

Pin headers with solder pin length optimised for wave flow soldering. The male connectors provide space for labelling and can be coded. HC = High Current.

### General ordering data

Type	SLD 5.08V/20/90B 3.2 SN...	Version
Order No.	<a href="#">1726360000</a>	PCB plug-in connector, male header, Dovetails for fixing blocks, THT
GTIN (EAN)	4032248061334	solder connection, 5.08 mm, Number of poles: 20, 90°, Solder pin
Qty.	20 ST	length (l): 3.2 mm, tinned, orange, Box

## BLL 5.08/10/90 3.2 SN OR BX

**Weidmüller Interface GmbH & Co. KG**  
 Klingenbergstraße 26  
 D-32758 Detmold  
 Germany

## Counterpart

www.weidmueller.com

### SL-SMT 5.08/180 Box

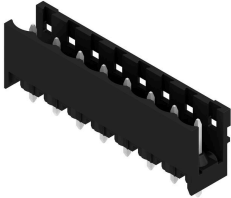

High-temperature-resistant, straight, open pin header. Packed in box or tape. On tape and with 1.5 mm solder pin, optimised for automatic assembly. 3.2 mm solder pin suitable for reflow and wave soldering. The pin headers provide space for labelling and can be coded. HC = High Current.

### General ordering data

Type	SL-SMT 5.08HC/10/180 1...	Version
Order No.	<a href="#">1775682001</a>	PCB plug-in connector, male header, open side, THT/THR solder connection, 5.08 mm, Number of poles: 10, 180°, Solder pin length (l): 1.5 mm, tinned, black, Box
GTIN (EAN)	4032248158324	
Qty.	50 ST	
Type	SL-SMT 5.08HC/10/180 3...	Version
Order No.	<a href="#">1838060000</a>	PCB plug-in connector, male header, open side, THT/THR solder connection, 5.08 mm, Number of poles: 10, 180°, Solder pin length (l): 3.2 mm, tinned, black, Box
GTIN (EAN)	4032248348121	
Qty.	50 ST	

### SL-SMT 5.08/180G Box

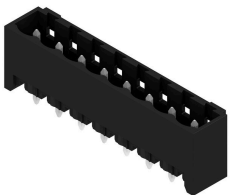

High-temperature-resistant pin header, packed in box or tape. On tape, with 1.5 mm solder pin, optimised for automatic assembly. 3.2 mm solder pin suitable for reflow and wave soldering. The pin headers provide space for labelling and can be coded. HC = High Current.

### General ordering data

Type	SL-SMT 5.08HC/10/180G 1...	Version
Order No.	<a href="#">1776002001</a>	PCB plug-in connector, male header, closed side, THT/THR solder connection, 5.08 mm, Number of poles: 10, 180°, Solder pin length (l): 1.5 mm, tinned, black, Box
GTIN (EAN)	4032248158997	
Qty.	50 ST	
Type	SL-SMT 5.08HC/10/180G 3...	Version
Order No.	<a href="#">1838290000</a>	PCB plug-in connector, male header, closed side, THT/THR solder connection, 5.08 mm, Number of poles: 10, 180°, Solder pin length (l): 3.2 mm, tinned, black, Box
GTIN (EAN)	4032248348350	
Qty.	50 ST	

## BLL 5.08/10/90 3.2 SN OR BX

Weidmüller Interface GmbH & Co. KG  
Klingenbergstraße 26  
D-32758 Detmold  
Germany

## Counterpart

www.weidmueller.com

## SL-SMT 5.08HC/90 Box



High-temperature-resistant, 90° angled, open male header. Packed in box or tape. On tape, with 1.5 mm solder pin, optimised for automatic assembly. 3.2 mm solder pin suitable for reflow and wave soldering. The pin headers provide space for labelling and can be coded. HC = High Current.

## General ordering data

Type	SL-SMT 5.08HC/10/90 1.5...	Version
Order No.	<a href="#">1774842001</a>	PCB plug-in connector, male header, open side, THT/THR solder connection, 5.08 mm, Number of poles: 10, 90°, Solder pin length (l):
GTIN (EAN)	4032248155880	
Qty.	50 ST	1.5 mm, tinned, black, Box
Type	SL-SMT 5.08HC/10/90 3.2...	Version
Order No.	<a href="#">1780030000</a>	PCB plug-in connector, male header, open side, THT/THR solder connection, 5.08 mm, Number of poles: 10, 90°, Solder pin length (l):
GTIN (EAN)	4032248165353	
Qty.	50 ST	3.2 mm, tinned, black, Box

## SL-SMT 5.08HC/90G Box



High-temperature-resistant pin header, packed in box or tape. On tape, with 1.5 mm solder pin, optimised for automatic assembly. 3.2 mm solder pin suitable for reflow and wave soldering. The pin headers provide space for labelling and can be coded. HC = High Current.

## General ordering data

Type	SL-SMT 5.08HC/10/90G 1....	Version
Order No.	<a href="#">1775082001</a>	PCB plug-in connector, male header, closed side, THT/THR solder connection, 5.08 mm, Number of poles: 10, 90°, Solder pin length (l):
GTIN (EAN)	4032248156559	
Qty.	50 ST	1.5 mm, tinned, black, Box
Type	SL-SMT 5.08HC/10/90G 1....	Version
Order No.	<a href="#">1775083001</a>	PCB plug-in connector, male header, closed side, THT/THR solder connection, 5.08 mm, Number of poles: 10, 90°, Solder pin length (l):
GTIN (EAN)	4032248166312	
Qty.	30 ST	1.5 mm, tinned, black, Tray
Type	SL-SMT 5.08HC/10/90G 3...	Version
Order No.	<a href="#">1780260000</a>	PCB plug-in connector, male header, closed side, THT/THR solder connection, 5.08 mm, Number of poles: 10, 90°, Solder pin length (l):
GTIN (EAN)	4032248165582	
Qty.	50 ST	3.2 mm, tinned, black, Box

## BLL 5.08/10/90 3.2 SN OR BX

**Weidmüller Interface GmbH & Co. KG**  
 Klingenbergstraße 26  
 D-32758 Detmold  
 Germany

www.weidmueller.com

## Counterpart

### SLF 5.08/180 SN

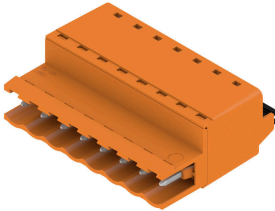

Male plug with PUSH IN wire connection and straight outlet direction, when used with BLF 5.08HC as wire-to-wire application for panel feed-through The male plugs provide space for labelling and can be coded.

#### General ordering data

Type	SLF 5.08/10/180 SN BK BX	Version
Order No.	<a href="#">1335710000</a>	PCB plug-in connector, male plug, 5.08 mm, Number of poles: 10,
GTIN (EAN)	4050118139143	180°, PUSH IN with actuator, Clamping range, max. : 3.31 mm², Box
Qty.	36 ST	
Type	SLF 5.08/10/180 SN OR BX	Version
Order No.	<a href="#">1335410000</a>	PCB plug-in connector, male plug, 5.08 mm, Number of poles: 10,
GTIN (EAN)	4050118138719	180°, PUSH IN with actuator, Clamping range, max. : 3.31 mm², Box
Qty.	36 ST	

### SLF 5.08/180B SN

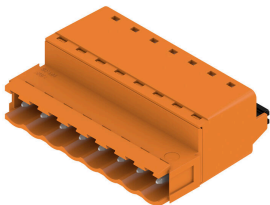

Male plug with PUSH IN wire connection and straight outlet direction, when used with BLF 5.08HC as wire-to-wire application for panel feed-through The male plugs provide space for labelling and can be coded.

#### General ordering data

Type	SLF 5.08/10/180B SN BK ...	Version
Order No.	<a href="#">1335940000</a>	PCB plug-in connector, male plug, 5.08 mm, Number of poles: 10,
GTIN (EAN)	4050118138993	180°, PUSH IN with actuator, Clamping range, max. : 3.31 mm², Box
Qty.	30 ST	
Type	SLF 5.08/10/180B SN OR ...	Version
Order No.	<a href="#">1335530000</a>	PCB plug-in connector, male plug, 5.08 mm, Number of poles: 10,
GTIN (EAN)	4050118139044	180°, PUSH IN with actuator, Clamping range, max. : 3.31 mm², Box
Qty.	30 ST	

## BLL 5.08/10/90 3.2 SN OR BX

**Weidmüller Interface GmbH & Co. KG**  
 Klingenbergstraße 26  
 D-32758 Detmold  
 Germany

www.weidmueller.com

## Counterpart

### SLF 5.08/180DF SN

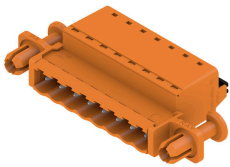

Male plug with PUSH IN wire connection and straight outlet direction, when used with BLF 5.08HC as wire-to-wire application for panel feed-through The male plugs provide space for labelling and can be coded.

#### General ordering data

Type	SLF 5.08/10/180DF SN OR...	Version
Order No.	<a href="#">1353680000</a>	PCB plug-in connector, male plug, 5.08 mm, Number of poles: 10,
GTIN (EAN)	4050118156423	180°, PUSH IN with actuator, Clamping range, max.: 3.31 mm², Box
Qty.	24 ST	

### SLT 5.08/180DF SN

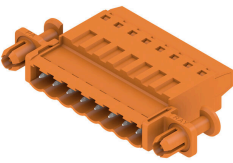

Male plugs with screw TOP wire connection. The male plug provides space for labelling and can be coded.

#### General ordering data

Type	SLT 5.08/10/180DF SN OR...	Version
Order No.	<a href="#">1353450000</a>	PCB plug-in connector, male plug, 5.08 mm, Number of poles: 10,
GTIN (EAN)	4050118156102	180°, TOP connection, Clamping range, max.: 2.5 mm², Box
Qty.	24 ST	

### SLT 5.08B

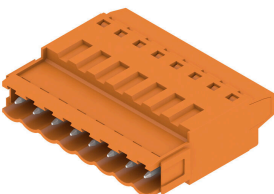

Male plugs with screw TOP wire connection. The male plug provides space for labelling and can be coded.

#### General ordering data

Type	SLT 5.08/10/180B SN OR ...	Version
Order No.	<a href="#">1611790000</a>	PCB plug-in connector, male plug, 5.08 mm, Number of poles: 10,
GTIN (EAN)	4008190192679	180°, TOP connection, Clamping range, max.: 2.5 mm², Box
Qty.	50 ST	

## BLL 5.08/10/90 3.2 SN OR BX

**Weidmüller Interface GmbH & Co. KG**  
 Klingenbergstraße 26  
 D-32758 Detmold  
 Germany

## Counterpart

www.weidmueller.com

## SLS 5.08/180 SN

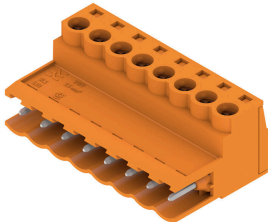

Male plugs with clamping-yoke screw wire-connect system. The male plugs provide space for labelling and can be coded.

## General ordering data

Type	SLS 5.08/10/180 SN OR BX	Version
Order No.	<a href="#">1627170000</a>	PCB plug-in connector, male plug, 5.08 mm, Number of poles: 10,
GTIN (EAN)	4008190199685	180°, Clamping yoke connection, Clamping range, max. : 3.31 mm²,
Qty.	36 ST	Box

## SLS 5.08/180B

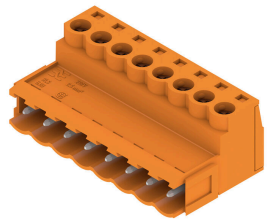

Male plugs with clamping-yoke screw wire-connect system. The male plugs provide space for labelling and can be coded.

## General ordering data

Type	SLS 5.08/10/180B SN OR ...	Version
Order No.	<a href="#">1627320000</a>	PCB plug-in connector, male plug, 5.08 mm, Number of poles: 10,
GTIN (EAN)	4008190199838	180°, Clamping yoke connection, Clamping range, max. : 3.31 mm²,
Qty.	30 ST	Box

## SLS 5.08TB KF35



Male plugs with clamping-yoke screw wire-connect system. With clip-on feet for attaching the male plugs on rail. The male plugs provide space for labelling and can be coded.

## General ordering data

Type	SLS 5.08/10/180TB KF SN...	Version
Order No.	<a href="#">1846160000</a>	PCB plug-in connector, male plug, 5.08 mm, Number of poles: 10,
GTIN (EAN)	4032248362448	180°, Clamping yoke connection, Clamping range, max. : 3.31 mm²,
Qty.	10 ST	Box

**Counterpart****SLS 5.08TB RF15**

Male plugs with clamping-yoke screw wire-connect system. With clip-on feet for attaching the male plugs on rail. The male plugs provide space for labelling and can be coded.

**General ordering data**

Type	SLS 5.08/10/180TB RF15 ...	Version
Order No.	<a href="#">1846080000</a>	PCB plug-in connector, male plug, 5.08 mm, Number of poles: 10,
GTIN (EAN)	4032248362363	180°, Clamping yoke connection, Clamping range, max. : 3.31 mm²,
Qty.	10 ST	Box