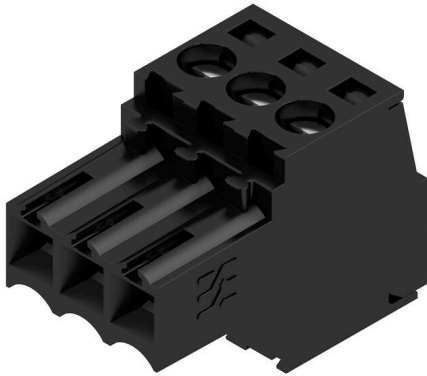

BL 3.50/03/180 SN BK BX

Weidmüller Interface GmbH & Co. KG
 Klingenbergstraße 26
 D-32758 Detmold
 Germany

www.weidmueller.com

Product image

Female connectors with clamping yoke screw system for connecting conductors at 3.50 mm pitch. They provide space for labelling and can be coded.

General ordering data

| | |
|--------------|--|
| Version | PCB plug-in connector, female plug, 3.50 mm, Number of poles: 3, 180°, Clamping yoke connection, Clamping range, max. : 1.5 mm², Box |
| Order No. | 1615680000 |
| Type | BL 3.50/03/180 SN BK BX |
| GTIN (EAN) | 4008190058906 |
| Qty. | 174 items |
| Product data | IEC: 320 V / 17 A / 0.2 - 1.5 mm² UL: 300 V / 10 A / AWG 28 - AWG 14 |
| Packaging | Box |

BL 3.50/03/180 SN BK BX

Weidmüller Interface GmbH & Co. KG
 Klingenbergstraße 26
 D-32758 Detmold
 Germany

www.weidmueller.com

Technical data

Approvals

Approvals



| | |
|-----------------------|----------------------------|
| ROHS | Conform |
| UL File Number Search | UL Website |
| Certificate No. (UR) | E60693 |

Dimensions and weights

| | | | |
|------------|---------|-----------------|-------------|
| Depth | 18.5 mm | Depth (inches) | 0.7283 inch |
| Height | 13 mm | Height (inches) | 0.5118 inch |
| Width | 10.5 mm | Width (inches) | 0.4134 inch |
| Net weight | 1.66 g | | |

Environmental Product Compliance

| | | | |
|--------------------------|-----------------------------|------------------|--|
| RoHS Compliance Status | Compliant without exemption | | |
| REACH SVHC | No SVHC above 0.1 wt% | | |
| Product Carbon Footprint | Cradle to gate | 0,235 kg CO2 eq. | |

System Parameters

| | | | |
|--|-------------------------------------|-------------------|-----------------------------|
| Product family | OMNIMATE Signal - series BL/SL 3.50 | | |
| Type of connection | Field connection | | |
| Wire connection method | Clamping yoke connection | | |
| Pitch in mm (P) | 3.50 mm | | |
| Pitch in inches (P) | 0.138 " | | |
| Conductor outlet direction | 180° | | |
| Number of poles | 3 | | |
| L1 in mm | 7.00 mm | | |
| L1 in inches | 0.276 " | | |
| Number of rows | 1 | | |
| Pin series quantity | 1 | | |
| Rated cross-section | 1.5 mm ² | | |
| Touch-safe protection acc. to DIN VDE 57 106 | Safe from finger touch | | |
| Touch-safe protection acc. to DIN VDE 0470 | IP20 plugged/ IP10 unplugged | | |
| Protection degree | IP20, when fully mounted | | |
| Volume resistance | ≤5 mΩ | | |
| Can be coded | Yes | | |
| Stripping length | 6 mm | | |
| Clamping screw | M 2 | | |
| Screwdriver blade | 0.4 x 2.5 | | |
| Screwdriver blade standard | DIN 5264 | | |
| Plugging cycles | 25 | | |
| Plugging force/pole, max. | 7 N | | |
| Pulling force/pole, max. | 5 N | | |
| Tightening torque | Torque type | Wire connection | |
| | Usage information | Tightening torque | min. 0.2 Nm max. 0.25 Nm |

BL 3.50/03/180 SN BK BX

Weidmüller Interface GmbH & Co. KG
 Klingenbergstraße 26
 D-32758 Detmold
 Germany

www.weidmueller.com

Technical data

Material data

| | | | |
|---------------------------------------|----------|---------------------------------------|----------------------------|
| Insulating material | PBT | Colour | black |
| Colour chart (similar) | RAL 9011 | Insulating material group | IIIa |
| Comparative Tracking Index (CTI) | ≥ 200 | Moisture Level (MSL) | |
| UL 94 flammability rating | V-0 | Contact material | Cu-alloy |
| Contact surface | tinned | Layer structure of plug contact | 4...8 µm Sn hot-dip tinned |
| Storage temperature, min. | -40 °C | Storage temperature, max. | 70 °C |
| Operating temperature, min. | -50 °C | Operating temperature, max. | 100 °C |
| Temperature range, installation, min. | -30 °C | Temperature range, installation, max. | 100 °C |

Conductors suitable for connection

| | |
|---|----------------------|
| Clamping range, min. | 0.08 mm ² |
| Clamping range, max. | 1.5 mm ² |
| Wire connection cross section AWG, min. | AWG 28 |
| Wire connection cross section AWG, max. | AWG 14 |
| Solid, min. H05(07) V-U | 0.2 mm ² |
| Solid, max. H05(07) V-U | 1.5 mm ² |
| Flexible, min. H05(07) V-K | 0.2 mm ² |
| Flexible, max. H05(07) V-K | 1.5 mm ² |
| w. plastic collar ferrule, DIN 46228 pt 4, 0.2 mm ² min. | |
| w. plastic collar ferrule, DIN 46228 pt 4, 1.5 mm ² max. | |
| w. wire end ferrule, DIN 46228 pt 1, min. | 0.2 mm ² |
| w. wire end ferrule, DIN 46228 pt 1, max. | 1.5 mm ² |
| Plug gauge in accordance with EN 60999 a x b; ø | 2.4 mm x 1.5 mm |

| | | | |
|--|--|------------------------------|----------------------------|
| Clampable conductor | Cross-section for conductor connection | Type | fine-wired |
| | | nominal | 0.5 mm ² |
| wire end ferrule | wire end ferrule | Stripping length | nominal 8 mm |
| | | Recommended wire-end ferrule | H0.5/12 OR |
| | | Stripping length | nominal 6 mm |
| | | Recommended wire-end ferrule | H0.5/6 |
| Cross-section for conductor connection | Cross-section for conductor connection | Type | fine-wired |
| | | nominal | 0.75 mm ² |
| wire end ferrule | wire end ferrule | Stripping length | nominal 8 mm |
| | | Recommended wire-end ferrule | H0.75/12 W |
| | | Stripping length | nominal 6 mm |
| | | Recommended wire-end ferrule | H0.75/6 |
| Cross-section for conductor connection | Cross-section for conductor connection | Type | fine-wired |
| | | nominal | 1 mm ² |
| wire end ferrule | wire end ferrule | Stripping length | nominal 8 mm |
| | | Recommended wire-end ferrule | H1.0/12 GE |
| | | Stripping length | nominal 6 mm |
| | | Recommended wire-end ferrule | H1.0/6 |
| Cross-section for conductor connection | Cross-section for conductor connection | Type | fine-wired |
| | | nominal | 0.25 mm ² |
| wire end ferrule | wire end ferrule | Stripping length | nominal 8 mm |

BL 3.50/03/180 SN BK BX

Weidmüller Interface GmbH & Co. KG
 Klingenbergstraße 26
 D-32758 Detmold
 Germany

www.weidmueller.com

Technical data

| | | | |
|----------------|--|------------------------------|------------------------------|
| | | Recommended wire-end ferrule | HO,25/10 HBL |
| | | Stripping length | nominal 5 mm |
| | | Recommended wire-end ferrule | HO,25/5 |
| | Cross-section for conductor connection | Type | fine-wired |
| | | nominal | 0.34 mm ² |
| | wire end ferrule | Stripping length | nominal 8 mm |
| | | Recommended wire-end ferrule | HO,34/10 TK |
| Reference text | The outside diameter of the plastic collar should not be larger than the pitch (P), Length of ferrules is to be chosen depending on the product and the rated voltage. | | |

Rated data acc. to IEC

| | | | |
|---|------------------------|---|-------------------|
| tested acc. to standard | IEC 60664-1, IEC 61984 | Rated current, min. number of poles (Tu=20°C) | 17 A |
| Rated current, max. number of poles (Tu=20°C) | 12 A | Rated current, min. number of poles (Tu=40°C) | 14.5 A |
| Rated current, max. number of poles (Tu=40°C) | 10 A | Rated voltage for surge voltage class / pollution degree II/2 | 320 V |
| Rated voltage for surge voltage class / pollution degree III/2 | 160 V | Rated voltage for surge voltage class / pollution degree III/3 | 160 V |
| Rated impulse voltage for surge voltage class/ pollution degree II/2 | 2.5 kV | Rated impulse voltage for surge voltage class/ pollution degree III/2 | 2.5 kV |
| Rated impulse voltage for surge voltage class/ contamination degree III/3 | 2.5 kV | Short-time withstand current resistance | 3 x 1s with 100 A |

Rated data acc. to CSA

| | | | |
|-----------------------------------|--|-----------------------------------|----------------|
| Institute (CSA) | CSA | Certificate No. (CSA) | 154685-1318353 |
| Rated voltage (Use group B / CSA) | 300 V | Rated voltage (Use group D / CSA) | 300 V |
| Rated current (Use group B / CSA) | 10 A | Rated current (Use group D / CSA) | 10 A |
| Wire cross-section, AWG, min. | AWG 28 | Wire cross-section, AWG, max. | AWG 14 |
| Reference to approval values | Specifications are maximum values, details - see approval certificate. | | |

Rated data acc. to UL 1059

| | | | |
|---------------------------------------|--|---------------------------------------|--------|
| Institute (UR) | UR | Certificate No. (UR) | E60693 |
| Rated voltage (Use group B / UL 1059) | 300 V | Rated voltage (Use group D / UL 1059) | 300 V |
| Rated current (Use group B / UL 1059) | 10 A | Rated current (Use group D / UL 1059) | 10 A |
| Wire cross-section, AWG, min. | AWG 28 | Wire cross-section, AWG, max. | AWG 14 |
| Reference to approval values | Specifications are maximum values, details - see approval certificate. | | |

Packing

| | | | |
|-----------|-----------|------------|-----------|
| Packaging | Box | VPE length | 353.00 mm |
| VPE width | 136.00 mm | VPE height | 24.00 mm |

Type tests

| | | |
|------------------------------|------------|--|
| Test: Durability of markings | Standard | DIN EN 61984 section 7.3.2 / 09.02 taking pattern from DIN EN 60068-2-70 / 07.96 |
| | Test | mark of origin, type identification, approval marking SEV, approval marking CSA |
| | Evaluation | available |

Technical data

| | | | |
|---|---|--|-------------------------------------|
| | Test | durability | |
| | Evaluation | passed | |
| Test: Misengagement (Non-interchangeability) | Standard | DIN EN 61984 section 6.3 and 6.9.1 / 09.02, DIN IEC 60512 part 7 section 5 / 05.94 | |
| | Test | 180° turned with coding elements | |
| | Evaluation | passed | |
| Test: Clampable cross section | Standard | DIN EN 60999-1 section 7 and 9.1 / 12.00, DIN EN 60947-1 section 8.2.4.5.1 / 12.99 | |
| | Conductor type | Type of conductor and conductor cross-section | solid 0.2 mm ² |
| | | Type of conductor and conductor cross-section | stranded 0.2 mm ² |
| | | Type of conductor and conductor cross-section | solid 1.5 mm ² |
| | | Type of conductor and conductor cross-section | stranded 1.5 mm ² |
| | | Type of conductor and conductor cross-section | AWG 28/1 |
| | | Type of conductor and conductor cross-section | AWG 28/19 |
| | | Type of conductor and conductor cross-section | AWG 16/1 |
| | | Type of conductor and conductor cross-section | AWG 16/19 |
| | Evaluation | passed | |
| Test for damage to and accidental loosening of conductors | Standard | DIN EN 60999-1 section 9.4 / 12.00 | |
| | Requirement | 0.2 kg | |
| | Conductor type | Type of conductor and conductor cross-section | AWG 28/1 |
| | | Type of conductor and conductor cross-section | AWG 28/19 |
| | Evaluation | passed | |
| | Requirement | 0.3 kg | |
| | Conductor type | Type of conductor and conductor cross-section | 2 × AWG 24/1 |
| | | Type of conductor and conductor cross-section | 2 × AWG 24/19 with wire end ferrule |
| | Evaluation | passed | |
| | Requirement | 0.4 kg | |
| Conductor type | Type of conductor and conductor cross-section | solid 1.5 mm ² | |
| | Type of conductor and conductor cross-section | stranded 1.5 mm ² | |
| | Type of conductor and conductor cross-section | AWG 16/7 | |
| Evaluation | passed | | |
| Pull-out test | Standard | DIN EN 60999-1 section 9.5 / 12.00 | |
| | Requirement | ≥5 N | |

Technical data

| | | |
|----------------|---|-------------------------------------|
| Conductor type | Type of conductor and conductor cross-section | AWG 28/1 |
| | Type of conductor and conductor cross-section | AWG 28/19 |
| Evaluation | passed | |
| Requirement | ≥10 N | |
| Conductor type | Type of conductor and conductor cross-section | 2 × AWG 24/1 |
| | Type of conductor and conductor cross-section | 2 × AWG 24/19 with wire end ferrule |
| Evaluation | passed | |
| Requirement | ≥40 N | |
| Conductor type | Type of conductor and conductor cross-section | H05V-U1.5 |
| | Type of conductor and conductor cross-section | H05V-K1.5 |
| | Type of conductor and conductor cross-section | AWG 16/7 |
| Evaluation | passed | |

Important note

IPC conformity Conformity: The products are developed, manufactured and delivered according international recognized standards and norms and comply with the assured properties in the data sheet resp. fulfill decorative properties in accordance with IPC-A-610 "Class 2". Further claims on the products can be evaluated on request.

- Notes**
- Additional variants on request
 - Gold-plated contact surfaces on request
 - Rated current related to rated cross-section & min. No. of poles.
 - Max. outer diameter of the conductor: 2.9 mm
 - Wire end ferrule without plastic collar to DIN 46228/1
 - Wire end ferrule with plastic collar to DIN 46228/4
 - P on drawing = pitch
 - Rated data refer only to the component itself. Clearance and creepage distances to other components are to be designed in accordance with the relevant application standards.
 - In accordance with IEC 61984, OMNIMATE-connectors are connectors without breaking capacity (COC). During designated use, connectors are not allowed to be engaged or disengaged when live or under load
 - Long term storage of the product with average temperature of 50 °C and maximum humidity 70%, 36 months

Classifications

| | | | |
|-------------|-------------|-------------|-------------|
| ETIM 8.0 | EC002638 | ETIM 9.0 | EC002638 |
| ETIM 10.0 | EC002638 | ECLASS 14.0 | 27-46-02-02 |
| ECLASS 15.0 | 27-46-02-02 | | |

BL 3.50/03/180 SN BK BX

Weidmüller Interface GmbH & Co. KG
 Klingenbergstraße 26
 D-32758 Detmold
 Germany

www.weidmueller.com

Drawings

Product image



Dimensional drawing



Graph

BL 3.50/.. /180 - SL-SMT 3.50/.. /90



Graph

BL 3.50/.. /180 - SLD 3.50/.. /90



Graph

BL 3.50/.. /180 - SLD 3.50V/.. /180



Graph

BL 3.50/.. /180 - SL 3.50/.. /90



BL 3.50/03/180 SN BK BX

Weidmüller Interface GmbH & Co. KG
 Klingenbergstraße 26
 D-32758 Detmold
 Germany

www.weidmueller.com

Accessories

Strain reliefs



For frequent load changes: the "trailer coupling" for plug-in connectors.

The strain relief can do more than just relieve the strain on conductors:

Simply clip onto the plug and

- bundle conductors
- guide cables
- use as a connection and disconnection aid

No damage to the connecting points, clear, tidy wiring and easy to handle.

User advantages: permanent heavy-duty connections for harsh industrial environments and convenient operation ensure improved system availability.

General ordering data

| | | |
|------------|----------------------------|--|
| Type | BL 3.50 ZE03 BK BX | Version |
| Order No. | 1627820000 | PCB plug-in connector, Accessories, Strain relief, black, Number of |
| GTIN (EAN) | 4008190202552 | poles: 3 |
| Qty. | 50 ST | |
| Type | BL 3.50 ZE03 OR BX | Version |
| Order No. | 1629680000 | PCB plug-in connector, Accessories, Strain relief, orange, Number of |
| GTIN (EAN) | 4008190202569 | poles: 3 |
| Qty. | 50 ST | |

Coding elements



Only connects what is supposed to be connected: the right connection at the right place.

Coding elements and locking devices clearly assign connecting elements during the manufacturing process and operation

The coding elements and locking devices are inserted prior to assembly or during the cable assembly phase.

The Weidmüller alternative: configure online using the variant configurator to precode prior to delivery.

Incorrect assembly on the circuit board and incorrect plugging of connecting elements is no longer possible.

The advantage: no troubleshooting during manufacture and no operational errors by the user.

General ordering data

| | | |
|------------|----------------------------|--|
| Type | BL SL 3.5 KO OR | Version |
| Order No. | 1693430000 | PCB plug-in connector, Accessories, Coding element, orange, Number |
| GTIN (EAN) | 4008190867447 | of poles: 1 |
| Qty. | 100 ST | |

BL 3.50/03/180 SN BK BX

Weidmüller Interface GmbH & Co. KG
 Klingenbergstraße 26
 D-32758 Detmold
 Germany

www.weidmueller.com

Accessories

Cover hoods



Effective protection, optimised ergonomics and closed design:
 From the strain relief on the connected conductors and the visual/contact protection and the disconnection aid: the optional retrofit hoods perform mechanical, visual and haptic functions.

The two half shells clip together securely, enclose the plug completely and offer the following functions:

- Cable ties or integrated cable clips provide strain relief.
- Marked with dekafix labels or adhesive strips
- Mounting side by side without losing poles or displacing the pitch
- Compatible: suitable for plugs with or without a flange or mounting bracket
- Flexible: 1-3 cable outlets leading in different directions available depending on the size

Weidmüller hoods offer added stability, better identification, complete compatibility and versatility. The result: maximum reliability and user-friendliness in any application.

General ordering data

| | | | |
|------------|----------------------------|---|--|
| Type | BL 3.50 AH03 BK BX | Version | |
| Order No. | 1745580000 | PCB plug-in connector, Accessories, Hood, black, Number of poles: 3 | |
| GTIN (EAN) | 4008190985141 | | |
| Qty. | 10 ST | | |

Coding elements



Only connects what is supposed to be connected: the right connection at the right place.

Coding elements and locking devices clearly assign connecting elements during the manufacturing process and operation

The coding elements and locking devices are inserted prior to assembly or during the cable assembly phase. The Weidmüller alternative: configure online using the variant configurator to precode prior to delivery.

Incorrect assembly on the circuit board and incorrect plugging of connecting elements is no longer possible. The advantage: no troubleshooting during manufacture and no operational errors by the user.

General ordering data

| | | | |
|------------|----------------------------|---|--|
| Type | BL SL 3.5 KO SW | Version | |
| Order No. | 1610100000 | PCB plug-in connector, Accessories, Coding element, black, Number of poles: 1 | |
| GTIN (EAN) | 4008190187637 | | |
| Qty. | 100 ST | | |

BL 3.50/03/180 SN BK BX

Weidmüller Interface GmbH & Co. KG
 Klingenbergstraße 26
 D-32758 Detmold
 Germany

www.weidmueller.com

Counterpart

SLD 3.50/90F



Two-tier pin header for wave soldering in 3.50 mm pitch. The connector is available in open, closed and flange versions. The male connectors provide space for labelling and can be coded. Packed in a cardboard box.

General ordering data

| | | |
|------------|----------------------------|--|
| Type | SLD 3.50/06/90F 3.2SN O... | Version |
| Order No. | 1633820000 | PCB plug-in connector, male header, Flange, THT solder connection, |
| GTIN (EAN) | 4008190258276 | 3.50 mm, Number of poles: 6, 90°, Solder pin length (l): 3.2 mm, |
| Qty. | 50 ST | tinned, orange, Box |

SL 3.50/135F



Pin headers for wave soldering in 3.50 mm pitch

- Plugging direction is parallel (90°), straight 180° or angled (135°) to the PCB
- Housing variant: screw flange (F)
- Packed in a cardboard box (BX)
- Pin header can be coded

General ordering data

| | | |
|------------|----------------------------|--|
| Type | SL 3.50/03/135F 3.2SN O... | Version |
| Order No. | 1643340000 | PCB plug-in connector, male header, Flange, THT solder connection, |
| GTIN (EAN) | 4008190282103 | 3.50 mm, Number of poles: 3, 135°, Solder pin length (l): 3.2 mm, |
| Qty. | 102 ST | tinned, orange, Box |

SL-SMT 3.5/180G Box



High-temperature-resistant male header, 3.50 mm pitch.

- Plugging direction parallel (90°), straight 180° or angled (135°) to PCB
- Housing variants: closed side (G), screw flange (F), solder flange (LF) or snap-on solder flange (RF)
- Optimised for the SMT process
- Pin length 3.2 mm universal for all soldering methods
- Pin length 1.5 mm optimised for reflow soldering methods
- Packed either in a box (BX) or tape-on-reel (RL)
- Male header can be coded

BL 3.50/03/180 SN BK BX

Weidmüller Interface GmbH & Co. KG
 Klingenbergstraße 26
 D-32758 Detmold
 Germany

Counterpart

www.weidmueller.com

General ordering data

| | | |
|------------|----------------------------|---|
| Type | SL-SMT 3.50/03/180G 1.5... | Version |
| Order No. | 1752992001 | PCB plug-in connector, male header, closed side, THT/THR solder |
| GTIN (EAN) | 4032248130917 | connection, 3.50 mm, Number of poles: 3, 180°, Solder pin length (l): |
| Qty. | 100 ST | 1.5 mm, tinned, black, Box |

SL-SMT 3.5/180F Box

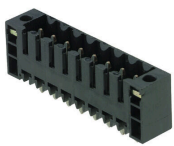

- High-temperature-resistant male header, 3.50 mm pitch.
- Plugging direction parallel (90°), straight 180° or angled (135°) to PCB
 - Housing variants: closed side (G), screw flange (F), solder flange (LF) or snap-on solder flange (RF)
 - Optimised for the SMT process
 - Pin length 3.2 mm universal for all soldering methods
 - Pin length 1.5 mm optimised for reflow soldering methods
 - Packed either in a box (BX) or tape-on-reel (RL)
 - Male header can be coded

General ordering data

| | | |
|------------|----------------------------|---|
| Type | SL-SMT 3.50/03/180F 1.5... | Version |
| Order No. | 1760972001 | PCB plug-in connector, male header, Flange, THT/THR solder |
| GTIN (EAN) | 4032248131549 | connection, 3.50 mm, Number of poles: 3, 180°, Solder pin length (l): |
| Qty. | 102 ST | 1.5 mm, tinned, black, Box |

SL-SMT 3.50/90F Tape

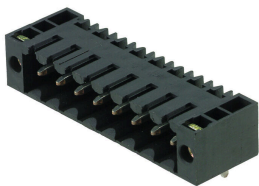

- High-temperature-resistant male header, 3.50 mm pitch.
- Plugging direction parallel (90°), straight 180° or angled (135°) to PCB
 - Housing variants: closed side (G), screw flange (F), solder flange (LF) or snap-on solder flange (RF)
 - Optimised for the SMT process
 - Pin length 3.2 mm universal for all soldering methods
 - Pin length 1.5 mm optimised for reflow soldering methods
 - Packed either in a box (BX) or tape-on-reel (RL)
 - Male header can be coded

General ordering data

| | | |
|------------|----------------------------|--|
| Type | SL-SMT 3.50/03/90F 1.5S... | Version |
| Order No. | 1762014001 | PCB plug-in connector, male header, Flange, THT/THR solder |
| GTIN (EAN) | 4032248136193 | connection, 3.50 mm, Number of poles: 3, 90°, Solder pin length (l): |
| Qty. | 385 ST | 1.5 mm, tinned, black, Tape |

BL 3.50/03/180 SN BK BX

Weidmüller Interface GmbH & Co. KG
 Klingenbergstraße 26
 D-32758 Detmold
 Germany

www.weidmueller.com

Counterpart

SL 3.50/90F



- Pin headers for wave soldering in 3.50 mm pitch
- Plugging direction is parallel (90°), straight 180° or angled (135°) to the PCB
 - Housing variant: screw flange (F)
 - Packed in a cardboard box (BX)
 - Pin header can be coded

General ordering data

| | | |
|------------|----------------------------|--|
| Type | SL 3.50/03/90F 3.2SN OR... | Version |
| Order No. | 1607050000 | PCB plug-in connector, male header, Flange, THT solder connection, |
| GTIN (EAN) | 4008190055257 | 3.50 mm, Number of poles: 3, 90°, Solder pin length (l): 3.2 mm, |
| Qty. | 100 ST | tinned, orange, Box |

SL 3.50/180F

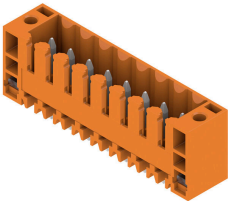

- Pin headers for wave soldering in 3.50 mm pitch
- Plugging direction is parallel (90°), straight 180° or angled (135°) to the PCB
 - Housing variant: screw flange (F)
 - Packed in a cardboard box (BX)
 - Pin header can be coded

General ordering data

| | | |
|------------|----------------------------|--|
| Type | SL 3.50/03/180F 3.2SN O... | Version |
| Order No. | 1607510000 | PCB plug-in connector, male header, Flange, THT solder connection, |
| GTIN (EAN) | 4008190163907 | 3.50 mm, Number of poles: 3, 180°, Solder pin length (l): 3.2 mm, |
| Qty. | 100 ST | tinned, orange, Box |

SL 3.50/90F

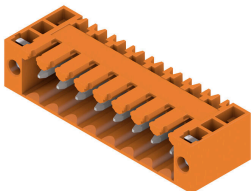

- Pin headers for wave soldering in 3.50 mm pitch
- Plugging direction is parallel (90°), straight 180° or angled (135°) to the PCB
 - Housing variant: screw flange (F)
 - Packed in a cardboard box (BX)
 - Pin header can be coded

General ordering data

| | | |
|------------|----------------------------|--|
| Type | SL 3.50/03/90F 4.5 SN B... | Version |
| Order No. | 1615540000 | PCB plug-in connector, male header, Flange, THT solder connection, |
| GTIN (EAN) | 4008190056667 | 3.50 mm, Number of poles: 3, 90°, Solder pin length (l): 4.5 mm, |
| Qty. | 100 ST | tinned, black, Box |

BL 3.50/03/180 SN BK BX

Weidmüller Interface GmbH & Co. KG
 Klingenbergstraße 26
 D-32758 Detmold
 Germany

www.weidmueller.com

Counterpart

SL 3.50/180F



- Pin headers for wave soldering in 3.50 mm pitch
- Plugging direction is parallel (90°), straight 180° or angled (135°) to the PCB
 - Housing variant: screw flange (F)
 - Packed in a cardboard box (BX)
 - Pin header can be coded

General ordering data

| | | |
|------------|----------------------------|--|
| Type | SL 3.50/03/180F 4.5 SN ... | Version |
| Order No. | 1616150000 | PCB plug-in connector, male header, Flange, THT solder connection, |
| GTIN (EAN) | 4008190068240 | 3.50 mm, Number of poles: 3, 180°, Solder pin length (l): 4.5 mm, |
| Qty. | 100 ST | tinned, black, Box |

SL 3.50/90F

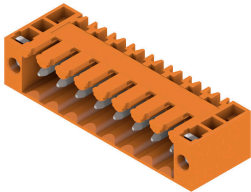

- Pin headers for wave soldering in 3.50 mm pitch
- Plugging direction is parallel (90°), straight 180° or angled (135°) to the PCB
 - Housing variant: screw flange (F)
 - Packed in a cardboard box (BX)
 - Pin header can be coded

General ordering data

| | | |
|------------|----------------------------|--|
| Type | SL 3.50/03/90F 4.5 SN O... | Version |
| Order No. | 1618070000 | PCB plug-in connector, male header, Flange, THT solder connection, |
| GTIN (EAN) | 4008190116194 | 3.50 mm, Number of poles: 3, 90°, Solder pin length (l): 4.5 mm, |
| Qty. | 100 ST | tinned, orange, Box |

SL-SMT 3.5/180F Box



- High-temperature-resistant male header, 3.50 mm pitch.
- Plugging direction parallel (90°), straight 180° or angled (135°) to PCB
 - Housing variants: closed side (G), screw flange (F), solder flange (LF) or snap-on solder flange (RF)
 - Optimised for the SMT process
 - Pin length 3.2 mm universal for all soldering methods
 - Pin length 1.5 mm optimised for reflow soldering methods
 - Packed either in a box (BX) or tape-on-reel (RL)
 - Male header can be coded

BL 3.50/03/180 SN BK BX

Weidmüller Interface GmbH & Co. KG
 Klingenbergstraße 26
 D-32758 Detmold
 Germany

Counterpart

www.weidmueller.com

General ordering data

| | | |
|------------|----------------------------|---|
| Type | SL-SMT 3.50/03/180F 3.2... | Version |
| Order No. | 1842780000 | PCB plug-in connector, male header, Flange, THT/THR solder |
| GTIN (EAN) | 4032248354146 | connection, 3.50 mm, Number of poles: 3, 180°, Solder pin length (l): |
| Qty. | 102 ST | 3.2 mm, tinned, black, Box |

SL-SMT 3.5/180G Box



- High-temperature-resistant male header, 3.50 mm pitch.
- Plugging direction parallel (90°), straight 180° or angled (135°) to PCB
 - Housing variants: closed side (G), screw flange (F), solder flange (LF) or snap-on solder flange (RF)
 - Optimised for the SMT process
 - Pin length 3.2 mm universal for all soldering methods
 - Pin length 1.5 mm optimised for reflow soldering methods
 - Packed either in a box (BX) or tape-on-reel (RL)
 - Male header can be coded

General ordering data

| | | |
|------------|----------------------------|---|
| Type | SL-SMT 3.50/03/180G 3.2... | Version |
| Order No. | 1842330000 | PCB plug-in connector, male header, closed side, THT/THR solder |
| GTIN (EAN) | 4032248353675 | connection, 3.50 mm, Number of poles: 3, 180°, Solder pin length (l): |
| Qty. | 100 ST | 3.2 mm, tinned, black, Box |

SL-SMT 3.5/90F Box



- High-temperature-resistant male header, 3.50 mm pitch.
- Plugging direction parallel (90°), straight 180° or angled (135°) to PCB
 - Housing variants: closed side (G), screw flange (F), solder flange (LF) or snap-on solder flange (RF)
 - Optimised for the SMT process
 - Pin length 3.2 mm universal for all soldering methods
 - Pin length 1.5 mm optimised for reflow soldering methods
 - Packed either in a box (BX) or tape-on-reel (RL)
 - Male header can be coded

General ordering data

| | | |
|------------|----------------------------|--|
| Type | SL-SMT 3.50/03/90F 3.2S... | Version |
| Order No. | 1842090000 | PCB plug-in connector, male header, Flange, THT/THR solder |
| GTIN (EAN) | 4032248353446 | connection, 3.50 mm, Number of poles: 3, 90°, Solder pin length (l): |
| Qty. | 102 ST | 3.2 mm, tinned, black, Box |

BL 3.50/03/180 SN BK BX

Weidmüller Interface GmbH & Co. KG
 Klingenbergstraße 26
 D-32758 Detmold
 Germany

www.weidmueller.com

Counterpart

SL-SMT 3.5/90LF Box



- High-temperature-resistant male header, 3.50 mm pitch.
- Plugging direction parallel (90°), straight 180° or angled (135°) to PCB
 - Housing variants: closed side (G), screw flange (F), solder flange (LF) or snap-on solder flange (RF)
 - Optimised for the SMT process
 - Pin length 3.2 mm universal for all soldering methods
 - Pin length 1.5 mm optimised for reflow soldering methods
 - Packed either in a box (BX) or tape-on-reel (RL)
 - Male header can be coded

General ordering data

| | | |
|------------|----------------------------|--|
| Type | SL-SMT 3.50/03/90LF 1.5... | Version |
| Order No. | 1804950000 | PCB plug-in connector, male header, Solder flange, THT/THR solder |
| GTIN (EAN) | 4032248268856 | connection, 3.50 mm, Number of poles: 3, 90°, Solder pin length (l): |
| Qty. | 102 ST | 1.5 mm, tinned, black, Box |

SL-SMT 3.5/180LF Box

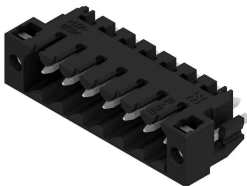

- High-temperature-resistant male header, 3.50 mm pitch.
- Plugging direction parallel (90°), straight 180° or angled (135°) to PCB
 - Housing variants: closed side (G), screw flange (F), solder flange (LF) or snap-on solder flange (RF)
 - Optimised for the SMT process
 - Pin length 3.2 mm universal for all soldering methods
 - Pin length 1.5 mm optimised for reflow soldering methods
 - Packed either in a box (BX) or tape-on-reel (RL)
 - Male header can be coded

General ordering data

| | | |
|------------|----------------------------|---|
| Type | SL-SMT 3.50/03/180LF 3.... | Version |
| Order No. | 1842550000 | PCB plug-in connector, male header, Solder flange, THT/THR solder |
| GTIN (EAN) | 4032248353910 | connection, 3.50 mm, Number of poles: 3, 180°, Solder pin length (l): |
| Qty. | 102 ST | 3.2 mm, tinned, black, Box |

SL-SMT 3.5/90LF Box



- High-temperature-resistant male header, 3.50 mm pitch.
- Plugging direction parallel (90°), straight 180° or angled (135°) to PCB
 - Housing variants: closed side (G), screw flange (F), solder flange (LF) or snap-on solder flange (RF)
 - Optimised for the SMT process
 - Pin length 3.2 mm universal for all soldering methods
 - Pin length 1.5 mm optimised for reflow soldering methods
 - Packed either in a box (BX) or tape-on-reel (RL)
 - Male header can be coded

BL 3.50/03/180 SN BK BX

Weidmüller Interface GmbH & Co. KG
 Klingenbergstraße 26
 D-32758 Detmold
 Germany

Counterpart

www.weidmueller.com

General ordering data

| | | |
|------------|----------------------------|--|
| Type | SL-SMT 3.50/03/90LF 3.2... | Version |
| Order No. | 1841870000 | PCB plug-in connector, male header, Solder flange, THT/THR solder |
| GTIN (EAN) | 4032248353224 | connection, 3.50 mm, Number of poles: 3, 90°, Solder pin length (l): |
| Qty. | 102 ST | 3.2 mm, tinned, black, Box |

SL-SMT 3.5/180LF Tape



- High-temperature-resistant male header, 3.50 mm pitch.
- Plugging direction parallel (90°), straight 180° or angled (135°) to PCB
 - Housing variants: closed side (G), screw flange (F), solder flange (LF) or snap-on solder flange (RF)
 - Optimised for the SMT process
 - Pin length 3.2 mm universal for all soldering methods
 - Pin length 1.5 mm optimised for reflow soldering methods
 - Packed either in a box (BX) or tape-on-reel (RL)
 - Male header can be coded

General ordering data

| | | |
|------------|----------------------------|---|
| Type | SL-SMT 3.50/03/180LF 1... | Version |
| Order No. | 1805230000 | PCB plug-in connector, male header, Solder flange, THT/THR solder |
| GTIN (EAN) | 4032248269105 | connection, 3.50 mm, Number of poles: 3, 180°, Solder pin length (l): |
| Qty. | 265 ST | 1.5 mm, tinned, black, Tape |

SL-SMT 3.5/180LF Box

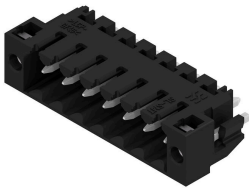

- High-temperature-resistant male header, 3.50 mm pitch.
- Plugging direction parallel (90°), straight 180° or angled (135°) to PCB
 - Housing variants: closed side (G), screw flange (F), solder flange (LF) or snap-on solder flange (RF)
 - Optimised for the SMT process
 - Pin length 3.2 mm universal for all soldering methods
 - Pin length 1.5 mm optimised for reflow soldering methods
 - Packed either in a box (BX) or tape-on-reel (RL)
 - Male header can be coded

General ordering data

| | | |
|------------|----------------------------|---|
| Type | SL-SMT 3.50/03/180LF 1... | Version |
| Order No. | 1804710000 | PCB plug-in connector, male header, Solder flange, THT/THR solder |
| GTIN (EAN) | 4032248268528 | connection, 3.50 mm, Number of poles: 3, 180°, Solder pin length (l): |
| Qty. | 102 ST | 1.5 mm, tinned, black, Box |

BL 3.50/03/180 SN BK BX

Weidmüller Interface GmbH & Co. KG
 Klingenbergstraße 26
 D-32758 Detmold
 Germany

Counterpart

www.weidmueller.com

SL-SMT 3.5/90LF Tape



High-temperature-resistant male header, 3.50 mm pitch.

- Plugging direction parallel (90°), straight 180° or angled (135°) to PCB
- Housing variants: closed side (G), screw flange (F), solder flange (LF) or snap-on solder flange (RF)
- Optimised for the SMT process
- Pin length 3.2 mm universal for all soldering methods
- Pin length 1.5 mm optimised for reflow soldering methods
- Packed either in a box (BX) or tape-on-reel (RL)
- Male header can be coded

General ordering data

| Type | SL-SMT 3.50/03/90LF 1.5... | Version |
|------------|----------------------------|--|
| Order No. | 1805320000 | PCB plug-in connector, male header, Solder flange, THT/THR solder |
| GTIN (EAN) | 4032248269570 | connection, 3.50 mm, Number of poles: 3, 90°, Solder pin length (l): |
| Qty. | 385 ST | 1.5 mm, tinned, black, Tape |

SLD 3.50/90

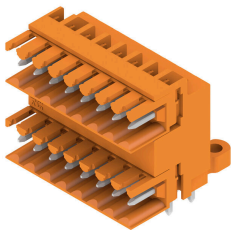

Two-tier pin header for wave soldering in 3.50 mm pitch. The connector is available in open, closed and flange versions. The male connectors provide space for labelling and can be coded. Packed in a cardboard box.

General ordering data

| Type | SLD 3.50/06/90 3.2SN OR... | Version |
|------------|----------------------------|--|
| Order No. | 1633360000 | PCB plug-in connector, male header, open side, THT solder |
| GTIN (EAN) | 4008190257811 | connection, 3.50 mm, Number of poles: 6, 90°, Solder pin length (l): |
| Qty. | 50 ST | 3.2 mm, tinned, orange, Box |

SLD 3.50/90G

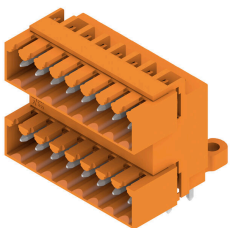

Two-tier pin header for wave soldering in 3.50 mm pitch. The connector is available in open, closed and flange versions. The male connectors provide space for labelling and can be coded. Packed in a cardboard box.

BL 3.50/03/180 SN BK BX

Weidmüller Interface GmbH & Co. KG
 Klingenbergstraße 26
 D-32758 Detmold
 Germany

Counterpart

www.weidmueller.com

General ordering data

| | | |
|------------|----------------------------|--|
| Type | SLD 3.50/06/90G 3.2SN O... | Version |
| Order No. | 1633590000 | PCB plug-in connector, male header, closed side, THT solder |
| GTIN (EAN) | 4008190258047 | connection, 3.50 mm, Number of poles: 6, 90°, Solder pin length (l): |
| Qty. | 50 ST | 3.2 mm, tinned, orange, Box |
| Type | SLD 3.50/06/90G 4.5SN B... | Version |
| Order No. | 1634280000 | PCB plug-in connector, male header, closed side, THT solder |
| GTIN (EAN) | 4008190258733 | connection, 3.50 mm, Number of poles: 6, 90°, Solder pin length (l): |
| Qty. | 50 ST | 4.5 mm, tinned, black, Box |

SL 3.50/90G

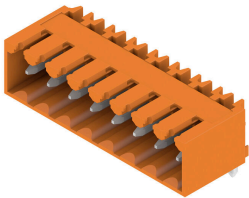

Pin headers for wave soldering in 3.50 mm pitch

- Plugging direction is parallel (90°), straight 180° or angled (135°) to the PCB
- Housing variant: screw flange (F)
- Packed in a cardboard box (BX)
- Pin header can be coded

General ordering data

| | | |
|------------|----------------------------|--|
| Type | SL 3.50/03/90G 3.2SN BK... | Version |
| Order No. | 1683230000 | PCB plug-in connector, male header, closed side, THT solder |
| GTIN (EAN) | 4008190475338 | connection, 3.50 mm, Number of poles: 3, 90°, Solder pin length (l): |
| Qty. | 100 ST | 3.2 mm, tinned, black, Box |

SLD 3.50V/90G

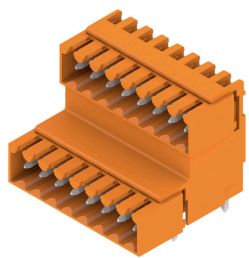

Double-level, staggered pin header for wave soldering at 3.50 mm pitch. They are available in closed and flanged versions. The male connectors provide space for labelling and can be coded.

General ordering data

| | | |
|------------|----------------------------|--|
| Type | SLD 3.50V/06/90G 4.5SN ... | Version |
| Order No. | 1699270000 | PCB plug-in connector, male header, closed side, THT solder |
| GTIN (EAN) | 4008190889104 | connection, 3.50 mm, Number of poles: 6, 90°, Solder pin length (l): |
| Qty. | 50 ST | 4.5 mm, tinned, black, Box |

BL 3.50/03/180 SN BK BX

Weidmüller Interface GmbH & Co. KG
 Klingenbergstraße 26
 D-32758 Detmold
 Germany

Counterpart

www.weidmueller.com

SL 3.50/90



Pin headers for wave soldering in 3.50 mm pitch

- Plugging direction is parallel (90°), straight 180° or angled (135°) to the PCB
- Housing variant: screw flange (F)
- Packed in a cardboard box (BX)
- Pin header can be coded

General ordering data

| | | |
|------------|----------------------------|--|
| Type | SL 3.50/03/90 3.2SN BK ... | Version |
| Order No. | 1723410000 | PCB plug-in connector, male header, open side, THT solder |
| GTIN (EAN) | 4008190365752 | connection, 3.50 mm, Number of poles: 3, 90°, Solder pin length (l): |
| Qty. | 100 ST | 3.2 mm, tinned, black, Box |

SL-SMT 3.5/90G Box



High-temperature-resistant male header, 3.50 mm pitch.

- Plugging direction parallel (90°), straight 180° or angled (135°) to PCB
- Housing variants: closed side (G), screw flange (F), solder flange (LF) or snap-on solder flange (RF)
- Optimised for the SMT process
- Pin length 3.2 mm universal for all soldering methods
- Pin length 1.5 mm optimised for reflow soldering methods
- Packed either in a box (BX) or tape-on-reel (RL)
- Male header can be coded

General ordering data

| | | |
|------------|----------------------------|--|
| Type | SL-SMT 3.50/03/90G 1.5S... | Version |
| Order No. | 1761552001 | PCB plug-in connector, male header, closed side, THT/THR solder |
| GTIN (EAN) | 4032248132041 | connection, 3.50 mm, Number of poles: 3, 90°, Solder pin length (l): |
| Qty. | 100 ST | 1.5 mm, tinned, black, Box |

SL-SMT 3.50/90 Tape

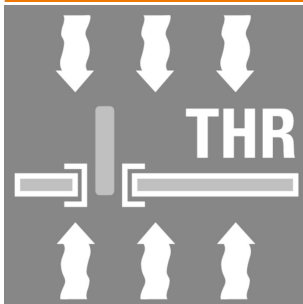

High-temperature-resistant male header, 3.50 mm pitch.

- Plugging direction parallel (90°), straight 180° or angled (135°) to PCB
- Housing variants: closed side (G), screw flange (F), solder flange (LF) or snap-on solder flange (RF)
- Optimised for the SMT process
- Pin length 3.2 mm universal for all soldering methods
- Pin length 1.5 mm optimised for reflow soldering methods
- Packed either in a box (BX) or tape-on-reel (RL)
- Male header can be coded

BL 3.50/03/180 SN BK BX

Weidmüller Interface GmbH & Co. KG
 Klingenbergstraße 26
 D-32758 Detmold
 Germany

Counterpart

www.weidmueller.com

General ordering data

| | | |
|------------|----------------------------|--|
| Type | SL-SMT 3.50/03/90 1.5SN... | Version |
| Order No. | 1761784001 | PCB plug-in connector, male header, open side, THT/THR solder |
| GTIN (EAN) | 4032248136094 | connection, 3.50 mm, Number of poles: 3, 90°, Solder pin length (l): |
| Qty. | 385 ST | 1.5 mm, tinned, black, Tape |

SL 3.50/90

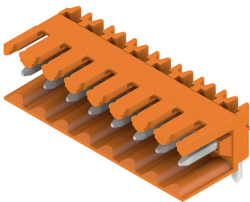

Pin headers for wave soldering in 3.50 mm pitch

- Plugging direction is parallel (90°), straight 180° or angled (135°) to the PCB
- Housing variant: screw flange (F)
- Packed in a cardboard box (BX)
- Pin header can be coded

General ordering data

| | | |
|------------|----------------------------|--|
| Type | SL 3.50/03/90 3.2SN OR ... | Version |
| Order No. | 1597220000 | PCB plug-in connector, male header, open side, THT solder |
| GTIN (EAN) | 4008190121792 | connection, 3.50 mm, Number of poles: 3, 90°, Solder pin length (l): |
| Qty. | 100 ST | 3.2 mm, tinned, orange, Box |

SL 3.50/180G

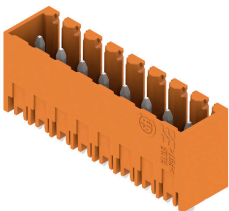

Pin headers for wave soldering in 3.50 mm pitch

- Plugging direction is parallel (90°), straight 180° or angled (135°) to the PCB
- Housing variant: screw flange (F)
- Packed in a cardboard box (BX)
- Pin header can be coded

General ordering data

| | | |
|------------|----------------------------|---|
| Type | SL 3.50/03/180G 3.2SN O... | Version |
| Order No. | 1604480000 | PCB plug-in connector, male header, closed side, THT solder |
| GTIN (EAN) | 4008190049621 | connection, 3.50 mm, Number of poles: 3, 180°, Solder pin length (l): |
| Qty. | 100 ST | 3.2 mm, tinned, orange, Box |
| Type | SL 3.50/03/180G 4.5SN O... | Version |
| Order No. | 1604630000 | PCB plug-in connector, male header, closed side, THT solder |
| GTIN (EAN) | 4008190075071 | connection, 3.50 mm, Number of poles: 3, 180°, Solder pin length (l): |
| Qty. | 100 ST | 4.5 mm, tinned, orange, Box |

BL 3.50/03/180 SN BK BX

Weidmüller Interface GmbH & Co. KG
 Klingenbergstraße 26
 D-32758 Detmold
 Germany

www.weidmueller.com

Counterpart

SL 3.50/180

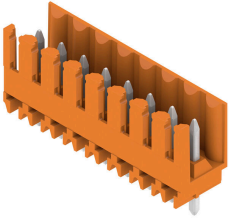

Pin headers for wave soldering in 3.50 mm pitch

- Plugging direction is parallel (90°), straight 180° or angled (135°) to the PCB
- Housing variant: screw flange (F)
- Packed in a cardboard box (BX)
- Pin header can be coded

General ordering data

| Type | SL 3.50/03/180 3.2SN OR... | Version |
|------------|----------------------------|---|
| Order No. | 1604780000 | PCB plug-in connector, male header, open side, THT solder |
| GTIN (EAN) | 4008190014322 | connection, 3.50 mm, Number of poles: 3, 180°, Solder pin length (l): |
| Qty. | 100 ST | 3.2 mm, tinned, orange, Box |

SL 3.50/90G

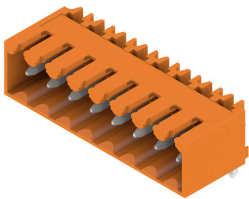

Pin headers for wave soldering in 3.50 mm pitch

- Plugging direction is parallel (90°), straight 180° or angled (135°) to the PCB
- Housing variant: screw flange (F)
- Packed in a cardboard box (BX)
- Pin header can be coded

General ordering data

| Type | SL 3.50/03/90G 3.2SN OR... | Version |
|------------|----------------------------|--|
| Order No. | 1605080000 | PCB plug-in connector, male header, closed side, THT solder |
| GTIN (EAN) | 4008190088538 | connection, 3.50 mm, Number of poles: 3, 90°, Solder pin length (l): |
| Qty. | 100 ST | 3.2 mm, tinned, orange, Box |

SL 3.50/180G

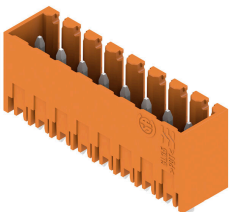

Pin headers for wave soldering in 3.50 mm pitch

- Plugging direction is parallel (90°), straight 180° or angled (135°) to the PCB
- Housing variant: screw flange (F)
- Packed in a cardboard box (BX)
- Pin header can be coded

General ordering data

| Type | SL 3.50/03/180G 3.2SN D... | Version |
|------------|----------------------------|---|
| Order No. | 1607360000 | PCB plug-in connector, male header, closed side, THT solder |
| GTIN (EAN) | 4008190064501 | connection, 3.50 mm, Number of poles: 3, 180°, Solder pin length (l): |
| Qty. | 100 ST | 3.2 mm, tinned, Signal green, Box |

BL 3.50/03/180 SN BK BX

Weidmüller Interface GmbH & Co. KG
Klingenbergstraße 26
D-32758 Detmold
Germany

www.weidmueller.com

Counterpart

SL 3.50/90



Pin headers for wave soldering in 3.50 mm pitch

- Plugging direction is parallel (90°), straight 180° or angled (135°) to the PCB
- Housing variant: screw flange (F)
- Packed in a cardboard box (BX)
- Pin header can be coded

General ordering data

| | | |
|------------|----------------------------|--|
| Type | SL 3.50/03/90 4.5SN BK ... | Version |
| Order No. | 1615300000 | PCB plug-in connector, male header, open side, THT solder |
| GTIN (EAN) | 4008190052126 | connection, 3.50 mm, Number of poles: 3, 90°, Solder pin length (l): |
| Qty. | 100 ST | 4.5 mm, tinned, black, Box |

SL 3.50/90G

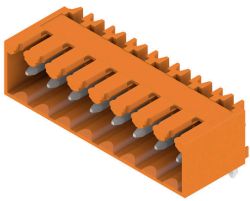

Pin headers for wave soldering in 3.50 mm pitch

- Plugging direction is parallel (90°), straight 180° or angled (135°) to the PCB
- Housing variant: screw flange (F)
- Packed in a cardboard box (BX)
- Pin header can be coded

General ordering data

| | | |
|------------|----------------------------|--|
| Type | SL 3.50/03/90G 4.5SN BK... | Version |
| Order No. | 1615420000 | PCB plug-in connector, male header, closed side, THT solder |
| GTIN (EAN) | 4008190054458 | connection, 3.50 mm, Number of poles: 3, 90°, Solder pin length (l): |
| Qty. | 100 ST | 4.5 mm, tinned, black, Box |

SL 3.50/180G

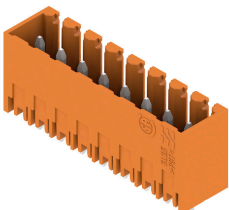

Pin headers for wave soldering in 3.50 mm pitch

- Plugging direction is parallel (90°), straight 180° or angled (135°) to the PCB
- Housing variant: screw flange (F)
- Packed in a cardboard box (BX)
- Pin header can be coded

General ordering data

| | | |
|------------|----------------------------|---|
| Type | SL 3.50/03/180G 4.5SN B... | Version |
| Order No. | 1616020000 | PCB plug-in connector, male header, closed side, THT solder |
| GTIN (EAN) | 4008190065324 | connection, 3.50 mm, Number of poles: 3, 180°, Solder pin length (l): |
| Qty. | 100 ST | 4.5 mm, tinned, black, Box |

BL 3.50/03/180 SN BK BX

Weidmüller Interface GmbH & Co. KG
 Klingenbergstraße 26
 D-32758 Detmold
 Germany

Counterpart

www.weidmueller.com

SL-SMT 3.5/90G Box



- High-temperature-resistant male header, 3.50 mm pitch.
- Plugging direction parallel (90°), straight 180° or angled (135°) to PCB
 - Housing variants: closed side (G), screw flange (F), solder flange (LF) or snap-on solder flange (RF)
 - Optimised for the SMT process
 - Pin length 3.2 mm universal for all soldering methods
 - Pin length 1.5 mm optimised for reflow soldering methods
 - Packed either in a box (BX) or tape-on-reel (RL)
 - Male header can be coded

General ordering data

| | | |
|------------|----------------------------|--|
| Type | SL-SMT 3.50/03/90G 3.2S... | Version |
| Order No. | 1841640000 | PCB plug-in connector, male header, closed side, THT/THR solder |
| GTIN (EAN) | 4032248352791 | connection, 3.50 mm, Number of poles: 3, 90°, Solder pin length (l): |
| Qty. | 100 ST | 3.2 mm, tinned, black, Box |

SL-SMT 3.5/180G Tape

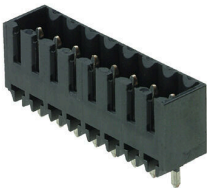

- High-temperature-resistant male header, 3.50 mm pitch.
- Plugging direction parallel (90°), straight 180° or angled (135°) to PCB
 - Housing variants: closed side (G), screw flange (F), solder flange (LF) or snap-on solder flange (RF)
 - Optimised for the SMT process
 - Pin length 3.2 mm universal for all soldering methods
 - Pin length 1.5 mm optimised for reflow soldering methods
 - Packed either in a box (BX) or tape-on-reel (RL)
 - Male header can be coded

General ordering data

| | | |
|------------|----------------------------|---|
| Type | SL-SMT 3.50/03/180G 1.5... | Version |
| Order No. | 1752994002 | PCB plug-in connector, male header, closed side, THT/THR solder |
| GTIN (EAN) | 4032248193103 | connection, 3.50 mm, Number of poles: 3, 180°, Solder pin length (l): |
| Qty. | 265 ST | 1.5 mm, tinned, black, Tape |

SL-SMT 3.5/90G Tape



- High-temperature-resistant male header, 3.50 mm pitch.
- Plugging direction parallel (90°), straight 180° or angled (135°) to PCB
 - Housing variants: closed side (G), screw flange (F), solder flange (LF) or snap-on solder flange (RF)
 - Optimised for the SMT process
 - Pin length 3.2 mm universal for all soldering methods
 - Pin length 1.5 mm optimised for reflow soldering methods
 - Packed either in a box (BX) or tape-on-reel (RL)
 - Male header can be coded

BL 3.50/03/180 SN BK BX

Weidmüller Interface GmbH & Co. KG
 Klingenbergstraße 26
 D-32758 Detmold
 Germany

Counterpart

www.weidmueller.com

General ordering data

| | | |
|------------|----------------------------|--|
| Type | SL-SMT 3.50/03/90G 1.5S... | Version |
| Order No. | 1761554002 | PCB plug-in connector, male header, closed side, THT/THR solder |
| GTIN (EAN) | 4032248193332 | connection, 3.50 mm, Number of poles: 3, 90°, Solder pin length (l): |
| Qty. | 385 ST | 1.5 mm, tinned, black, Tape |

SL-THR 3.5/135F

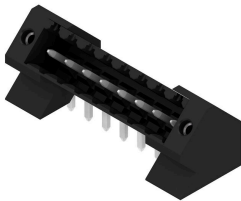

High-temperature-resistant male header, 3.50 mm pitch.

- Plugging direction parallel (90°), straight 180° or angled (135°) to PCB
- Housing variants: closed side (G), screw flange (F), solder flange (LF) or snap-on solder flange (RF)
- Optimised for the SMT process
- Pin length 3.2 mm universal for all soldering methods
- Pin length 1.5 mm optimised for reflow soldering methods
- Packed either in a box (BX) or tape-on-reel (RL)
- Male header can be coded

General ordering data

| | | |
|------------|----------------------------|---|
| Type | SL-SMT 3.50/03/135F 3.2... | Version |
| Order No. | 1003520000 | PCB plug-in connector, male header, Flange, THT/THR solder |
| GTIN (EAN) | 4032248700158 | connection, 3.50 mm, Number of poles: 3, 135°, Solder pin length (l): |
| Qty. | 102 ST | 3.2 mm, tinned, black, Box |