

## RJ45G1 R1V 3.3N4YG/YG TY

Weidmüller Interface GmbH & Co. KG

Klingenbergstraße 26

D-32758 Detmold

Germany

www.weidmueller.com



RJ45 transmitter sockets (magnetics) for gigabit applications (1000 base-T) with integrated compensation actively counteracts inductive and capacitive couplings and saves space on the PCB.

The product range encompasses the following designs:

- 90°, lying (horizontal) and 180°, standing (vertical)
- latch up / latch down
- THT, THR or SMD soldering processes
- Wide range of different design types, also with integrated LEDs and shield contact tabs
- Transmission rates of up to 1 Gbps
- Packed either in a tray (TY) or on a roll (tape-on-reel, RL)
- Compatible with modular RJ45 connector according to ANSI / TIA-1096-A and IEC 60603
- Dielectric strength  $\geq 1500$  V AC RMS (2250 V AC peak value) according to IEEE 802.3
- Dielectric strength  $\geq 1500$  V AC (peak value) or  $\geq 1500$  V DC according to IEC 60603
- Compliance with IEEE 802.3 requirements (1000Base-T, 1 Gbps, IEEE 802.3ab or 100Base-Tx, 100 Mbps, IEEE 802.3u) Properties and advantages:
  - Extended temperature range of  $-40$  °C to  $+85$  °C for maximum performance
  - Reinforced gold layer ( $30\mu\text{m}$ ) for improved corrosion protection
  - At least 0.3mm stand-off ensures a perfect soldering result

### General ordering data

Version	OMNIMATE Data - RJ45 transformer jack, PCB plug-in connector, THT/THR solder connection, 180°, none, Yes, Plugging cycles: 750, Number of poles: 10, PA 9T, 30...80 $\mu\text{m}$ Ni / $\geq 30$ $\mu\text{m}$ Au , Tray (manual assembly)
Order No.	<a href="#">1534760000</a>
Type	RJ45G1 R1V 3.3N4YG/YG TY
GTIN (EAN)	4050118338423
Qty.	120 items
Packaging	Tray (manual assembly)

## RJ45G1 R1V 3.3N4YG/YG TY

Weidmüller Interface GmbH & Co. KG  
Klingenbergstraße 26  
D-32758 Detmold  
Germany

www.weidmueller.com

## Technical data

## Approvals

Approvals



ROHS	Conform
UL File Number Search	<a href="#">UL Website</a>
Certificate No. (cURus)	E471884

## Dimensions and weights

Depth	16.8 mm	Depth (inches)	0.6614 inch
Height	20.3 mm	Height (inches)	0.7992 inch
Height of lowest version	17 mm	Width	16 mm
Width (inches)	0.6299 inch	Net weight	3.78 g

## Environmental Product Compliance

RoHS Compliance Status	Compliant without exemption
REACH SVHC	No SVHC above 0.1 wt%

## System specifications

Number of poles	10	LED	Yes
Solder pin length (l)	3.2 mm	Mounting onto the PCB	THT/THR solder connection
Pitch in inches (P)	0.050 "	Shielding material	Brass
Shielding	Yes	Side termination, characteristic	Solder flange
Solder eyelet hole diameter tolerance (D) ± 0.1 mm		Transmission rate	1000 Mbps
Number of solder pins per pole	1	Type of connection	Solder connection
Solder eyelet hole diameter (D)	0.9 mm	Product family	OMNIMATE Data - RJ45 transformer jack
Pitch in mm (P)	1.27 mm	Protection degree	IP20
Plugging cycles	750	Wiring	10-wire
Outgoing elbow	180°	Forward current	20 mA
Forward voltage, max.	2.5 V	Shield surface	nickel-plated
Colour of right LED	Green/yellow	Shield tabs	none
Performance-Category	1000 Mbps	Soldering process	Reflow soldering, Manual soldering, Wave soldering
Solder pin dimensions	0.40 x 0.30 mm, LED pins = 0.50 x 0.50 mm	Tolerance of solder pin position	± 0.15 mm
Forward voltage, min.	1.8 V	Colour of left LED	Green/yellow

## Electrical properties

Dielectric strength, contact / shield	1500 V DC	Dielectric strength, contact / contact	1000 V DC
Insulation resistance	≥ 500 MΩ	Nominal voltage	125 V
Rated current	1.5 A		

## Standards

Connector standard	IEC 60603-7-5 1, IEC 60603-7
--------------------	------------------------------

## Material data

Insulating material	PA 9T	Colour	black
Colour chart (similar)	RAL 9011	Insulating material group	II

Creation date 04.03.2026 06:41:56 MEZ

Catalogue status / Drawings

## RJ45G1 R1V 3.3N4YG/YG TY

**Weidmüller Interface GmbH & Co. KG**  
 Klingenbergstraße 26  
 D-32758 Detmold  
 Germany

[www.weidmueller.com](http://www.weidmueller.com)

### Technical data

Comparative Tracking Index (CTI)	≥ 500	Insulation resistance	≥ 500 MΩ
Moisture Level (MSL)	1	UL 94 flammability rating	V-0
Contact base material	Phosphorus bronze	Contact material	Cu-alloy
Contact surface	Gold over nickel	Layer structure of plug contact	30...80 μ" Ni / ≥ 30 μ" Au
Storage temperature, min.	-40 °C	Storage temperature, max.	85 °C
Operating temperature, min.	-40 °C	Operating temperature, max.	85 °C

### Packing

Packaging	Tray (manual assembly)	VPE length	314.00 mm
VPE width	190.00 mm	VPE height	68.00 mm

### Important note

Notes

### Classifications

ETIM 8.0	EC002637	ETIM 9.0	EC002637
ETIM 10.0	EC002637	ECLASS 14.0	27-46-02-01
ECLASS 15.0	27-46-02-01		

RJ45G1 R1V 3.3N4YG/YG TY

Weidmüller Interface GmbH & Co. KG  
 Klingenbergstraße 26  
 D-32758 Detmold  
 Germany

www.weidmueller.com

Drawings

Dimensioned drawing

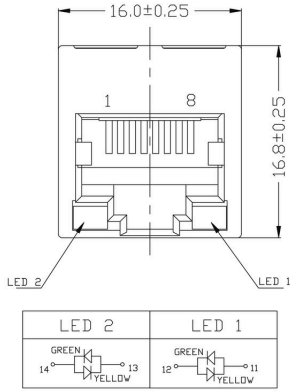

Dimensioned drawing

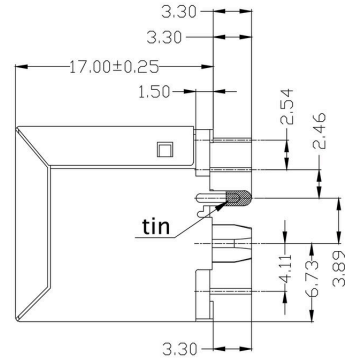

Dimensioned drawing

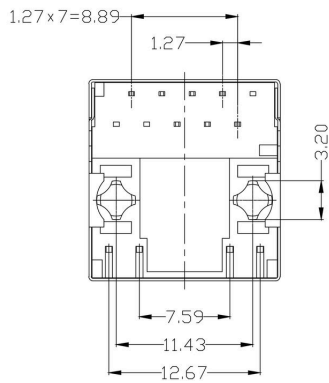

Dimensioned drawing

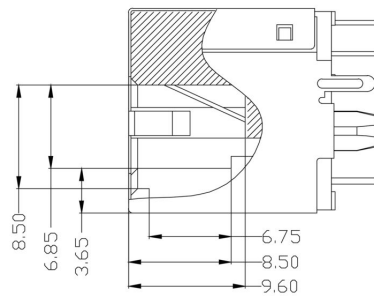

Dimensioned drawing

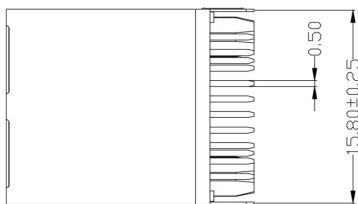

Wiring diagram

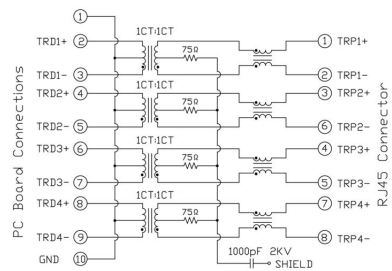

RJ45G1 R1V 3.3N4YG/YG TY

Weidmüller Interface GmbH & Co. KG  
 Klingenbergstraße 26  
 D-32758 Detmold  
 Germany

Drawings

www.weidmueller.com

PCB design

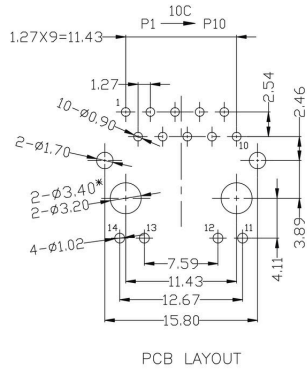

Code	Description	Value	Notes
<b>RJ45</b>	Connector Type	RJ45	
<b>G1</b>	Performance Category	G1	10/100/1000 Mbit
<b>R1</b>	Assembly on PCB	R1	Through Hole Reflow - THR
<b>1U</b>	Direction, latch style	1U	Horizontal (90°, side entry), latch up
<b>3.2E4</b>	Solder Pin length	3.2E4	3.2 mm
<b>GY/GY</b>	LED	GY/GY	Green-Yellow/Green-Yellow
<b>TY</b>	Packaging	TY	Tray in box (manual assembly)
		RL	Tape on Reel (automated assembly)
		Y/G	Yellow/Green
		G/Y	Green/Yellow (standard)
		GY/GY	Green-Yellow/Green-Yellow
		O/G	Orange/Green
		R/O	Red/Orange
		...	... (further combinations possible)
		N	without LED
	Contact surface thickness	4	1 = 3µ", 2 = 6µ", 3 = 15µ", 4 = 30µ", 5 = 50µ"
	EMI tabs (ground fingers)	E	E = with EMI tabs
		N	N = without EMI tabs
	Solder Pin length	3.2	3.2 mm
		1.6	1.6 mm
		D	SMD
	Direction, latch style	U	Horizontal (90°, side entry), latch up
		D	Horizontal (90°, side entry), latch down
		V	Vertical (180°, top entry)
		Y	Diagonal (45°), latch up
	Number of Ports	1	1 Port
		12; 14; ...	multi ports side by side, Multiport
		21; 41; ...	multi ports about each other, Multilevel
	Assembly on PCB	R	Through Hole Reflow - THR
		S	Soldering process: Wave or Reflow soldering
		T	Surface Mount Technology - SMT
			Soldering process: Reflow soldering
			Through Hole Technology - THT
			Soldering process: Wave
	Performance Category	C5	Category 5
		C6	Category 6
		C6A	Category 6A
		C6e	Category 6e
		M	10/100 Mbit
		G1	10/100/1000 Mbit
		G10	10 Gbit
		U	Unshielded
		MP	10/100 Mbit with POE
		MP+	10/100 Mbit with POE+

Type codes

## RJ45G1 R1V 3.3N4YG/YG TY

**Weidmüller Interface GmbH & Co. KG**  
 Klingenbergstraße 26  
 D-32758 Detmold  
 Germany

www.weidmueller.com

## Counterpart

### RJ45 crimp

RJ45 crimp plug-in connector according to IEC 60603-7-51 for wire outer diameters up to 1.05 mm



### General ordering data

Type	IE-P	Version
Order No.	<a href="#">8813100000</a>	RJ45 plug-in connector, without kink protection; 5.5 - 7.1 mm,
GTIN (EAN)	4032248512850	Cat.6A / Class EA (ISO/IEC 11801 2010), IP20
Qty.	100 ST	
Type	IE-P63	Version
Order No.	<a href="#">8813110000</a>	RJ45 plug-in connector, with kink protection; 5.5 - 6.2 mm, Cat.6A /
GTIN (EAN)	4032248512867	Class EA (ISO/IEC 11801 2010), IP20
Qty.	10 ST	
Type	IE-P70	Version
Order No.	<a href="#">8813120000</a>	RJ45 plug-in connector, with kink protection; 6.2 - 7.1 mm, Cat.6A /
GTIN (EAN)	4032248512874	Class EA (ISO/IEC 11801 2010), IP20
Qty.	10 ST	
Type	IE-PM-RJ45-TH	Version
Order No.	<a href="#">1963580000</a>	RJ45 crimp plug, Plug without bending protection sleeve, Cat.6A /
GTIN (EAN)	4032248645688	Class EA (ISO/IEC 11801 2010)
Qty.	100 ST	
Type	IE-PS-RJ45-TH-BK	Version
Order No.	<a href="#">1963590000</a>	RJ45 crimp plug, Plug with bending protection sleeve in black,
GTIN (EAN)	4032248645695	Cat.6A / Class EA (ISO/IEC 11801 2010)
Qty.	10 ST	
Type	IE-PS-RJ45-TH-BK-P	Version
Order No.	<a href="#">2584980000</a>	RJ45 crimp plug, with kink protection; 6.5 - 7.5 mm, Cat.5 (ISO/IEC
GTIN (EAN)	4050118593556	11801)
Qty.	10 ST	

### straight

RJ45 plug-in connector (no tools required) according to IEC 60603-7-51.



## RJ45G1 R1V 3.3N4YG/YG TY

**Weidmüller Interface GmbH & Co. KG**  
 Klingenbergstraße 26  
 D-32758 Detmold  
 Germany

www.weidmueller.com

## Counterpart

## General ordering data

Type	IE-PS-RJ45-FH-180-A-1.1	Version
Order No.	<a href="#">1992850000</a>	RJ45 plug with piercing contacts, straight, Cat.6A / Class EA (ISO/
GTIN (EAN)	4050118378115	IEC 11801 2010), EIA/TIA T568 A
Qty.	1 ST	
Type	IE-PS-RJ45-FH-180-A-1.6	Version
Order No.	<a href="#">1992820000</a>	RJ45 plug with piercing contacts, straight, Cat.6A / Class EA (ISO/
GTIN (EAN)	4050118377897	IEC 11801 2010), EIA/TIA T568 A
Qty.	1 ST	
Type	IE-PS-RJ45-FH-180-B-1.1	Version
Order No.	<a href="#">1992860000</a>	RJ45 plug with piercing contacts, straight, Cat.6A / Class EA (ISO/
GTIN (EAN)	4050118378108	IEC 11801 2010), EIA/TIA T568 B
Qty.	1 ST	
Type	IE-PS-RJ45-FH-180-B-1.6	Version
Order No.	<a href="#">1992830000</a>	RJ45 plug with piercing contacts, straight, Cat.6A / Class EA (ISO/
GTIN (EAN)	4050118377972	IEC 11801 2010), EIA/TIA T568 B
Qty.	1 ST	
Type	IE-PS-RJ45-FH-180-P-1.6	Version
Order No.	<a href="#">1992840000</a>	RJ45 plug with piercing contacts, straight, Cat.5 (ISO/IEC 11801),
GTIN (EAN)	4050118378023	PROFINET
Qty.	1 ST	

## angled with cable gland

RJ45 plug-in connector (no tools required) according to IEC 60603-7-51.



## General ordering data

Type	IE-PS-RJ45-FH-90-A-1.1	Version
Order No.	<a href="#">1518080000</a>	RJ45 plug with piercing contacts, angled, 4x90°, Cat.6A / Class EA
GTIN (EAN)	4050118324969	(ISO/IEC 11801 2010), EIA/TIA T568 A
Qty.	1 ST	
Type	IE-PS-RJ45-FH-90-A-1.6	Version
Order No.	<a href="#">1992870000</a>	RJ45 plug with piercing contacts, angled, 4x90°, Cat.6A / Class EA
GTIN (EAN)	4050118378054	(ISO/IEC 11801 2010), EIA/TIA T568 A
Qty.	1 ST	
Type	IE-PS-RJ45-FH-90-B-1.1	Version
Order No.	<a href="#">1518090000</a>	RJ45 plug with piercing contacts, angled, 4x90°, Cat.6A / Class EA
GTIN (EAN)	4050118325300	(ISO/IEC 11801 2010), EIA/TIA T568 B
Qty.	1 ST	
Type	IE-PS-RJ45-FH-90-B-1.6	Version
Order No.	<a href="#">1992890000</a>	RJ45 plug with piercing contacts, angled, 4x90°, Cat.6A / Class EA
GTIN (EAN)	4050118378122	(ISO/IEC 11801 2010), EIA/TIA T568 B
Qty.	1 ST	

## RJ45G1 R1V 3.3N4YG/YG TY

**Weidmüller Interface GmbH & Co. KG**  
 Klingenbergstraße 26  
 D-32758 Detmold  
 Germany

[www.weidmueller.com](http://www.weidmueller.com)

## Counterpart

Type	IE-PS-RJ45-FH-90-P-1.6	Version
Order No.	<a href="#">1518100000</a>	RJ45 plug with piercing contacts, angled, 4x90°, Cat.5 (ISO/IEC 11801), PROFINET
GTIN (EAN)	4050118325232	
Qty.	1 ST	

## RJ45 tool-free



RJ45 plug-in connector (tool-less) according to IEC 60603-7-51 for wire outer diameters up to 1.6 mm

## General ordering data

Type	IE-PS-RJ45-FH-BK	Version
Order No.	<a href="#">1963600000</a>	RJ45 IDC plug, Cat.6A / Class EA (ISO/IEC 11801 2010), 8-core, 4-core, EIA/TIA T568 A, EIA/TIA T568 B, PROFINET
GTIN (EAN)	4032248645725	
Qty.	10 ST	
Type	IE-PS-RJ45-FH-BK-A	Version
Order No.	<a href="#">1132040000</a>	RJ45 IDC plug, Cat.6A / Class EA (ISO/IEC 11801 2010), 8-core, EIA/TIA T568 A
GTIN (EAN)	4032248912155	
Qty.	10 ST	
Type	IE-PS-RJ45-FH-BK-B	Version
Order No.	<a href="#">1132050000</a>	RJ45 IDC plug, Cat.6A / Class EA (ISO/IEC 11801 2010), 8-core, EIA/TIA T568 B
GTIN (EAN)	4032248912148	
Qty.	10 ST	
Type	IE-PS-RJ45-FH-BK-P	Version
Order No.	<a href="#">1132060000</a>	RJ45 IDC plug, Cat.5 (ISO/IEC 11801), 4-core, PROFINET
GTIN (EAN)	4032248912162	
Qty.	10 ST	