

TIAL F20

Weidmüller Interface GmbH & Co. KG

Klingenbergstraße 26

D-32758 Detmold

Germany

www.weidmueller.com

Product image



Similar to illustration

Faster signal wiring with less space

To reduce wiring times, pre-assembled cables are used between the control system and the interface level and are simply connected to the TERMSERIES adapter. This enables throughput times in electrical cabinet building to be significantly reduced. The adapter has a universal fit and offers a genuine space advantage in interaction with the TERMSERIES products with identical contours.

- Reduced wiring time due to plug-and-play concept with pre-assembled cables
- Can be applied to the input and output sides of the TERMSERIES
- Ready for plus and minus switching logic
- High space-saving due to universal fit to other TERMSERIES products

General ordering data

Version	TERMSERIES, Adapter, 20-pole plug according to DIN EN 60603-13, long locking lever, Number of signal paths: 16, Rated voltage DC : 24 V, Rated current (per signal path): 60 mA
Order No.	1463550000
Type	TIAL F20
GTIN (EAN)	4050118331783
Qty.	1 items

TIAL F20

Weidmüller Interface GmbH & Co. KG

Klingenbergstraße 26

D-32758 Detmold

Germany

www.weidmueller.com

Technical data

Approvals

Approvals



ROHS Conform

UL File Number Search [UL Website](#)

Certificate no. (cULus) E141197

Dimensions and weights

Depth	62 mm	Depth (inches)	2.4409 inch
Height	43 mm	Height (inches)	1.6929 inch
Width	102 mm	Width (inches)	4.0157 inch
Net weight	88.4 g		

Temperatures

Storage temperature	-40 °C...85 °C	Ambient temperature	-40 °C...60 °C
Operating temperature		Humidity	5...95% (indoor), Tu = 40°C, without condensation

Environmental Product Compliance

RoHS Compliance Status Compliant with exemption

RoHS Exemption (if applicable/known) 7cl

REACH SVHC No SVHC above 0.1 wt%

Supply

Supply voltage 24 V DC \pm 20 % Status display Green LED

Signals

Rated voltage DC	24 V	DC Voltage, max.	30 V
Rated current (per signal path)	60 mA	Current (per signal path), max.	1 A
Total current of all signals, max.	1 A	Number of signal paths	16

General data

Colour	black		
UL94 flammability rating component	Component	Housing	
	UL94 flammability rating	V-0	

Insulation coordination

Rated voltage	32 V	Pollution severity	2
Surge voltage category	III	Impulse withstand voltage	1.5 kV
Protection degree	IP20 in installed state		

Further details of approvals / standards

Certificate No. (DNV) TAA00001E5 Certificate no. (cULus) E141197

TIAL F20

Weidmüller Interface GmbH & Co. KG

Klingenbergstraße 26
D-32758 Detmold
Germany

www.weidmueller.com

Technical data

Connection data (supply)

Wire connection method	PUSH IN	Number of terminals	4 (+,+, -,-)
Clamping range, rated connection, min.	0.13 mm ²	Clamping range, rated connection, max.	1.5 mm ²
Blade size (supply)	0.6 x 3.5 mm		

Connection data (signal)

Plug type	20-pole plug according to DIN EN 60603-13, long locking lever
-----------	---

Classifications

ETIM 8.0	EC002780	ETIM 9.0	EC002780
ETIM 10.0	EC002780	ECLASS 14.0	27-14-11-52
ECLASS 15.0	27-14-11-52		

TIAL F20

Weidmüller Interface GmbH & Co. KG
 Klingenbergstraße 26
 D-32758 Detmold
 Germany

Drawings

www.weidmueller.com

Wiring diagram

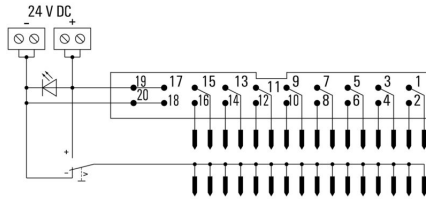

Example of use

Function of potential switch

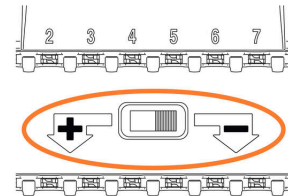

The potential switch, located between contact rows of TERMSERIES adapter, is used to switch the potential of the lower contact row to "+" or "-" potential of supply voltage.

Example of use

Installation note for adapter on input

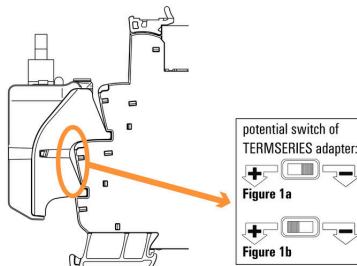
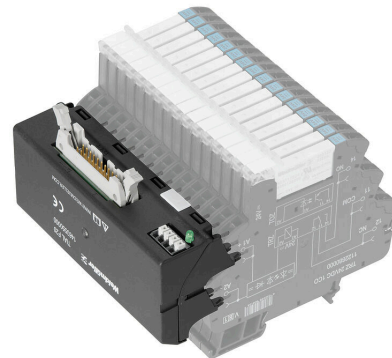

Figure 1a: Using adapter with positive-switching logic: switch potential switch at adapter to "-" position, installation recommended on **24 V DC** input (A1/A2).

Figure 1b: Using adapter with negative-switching logic: switch potential switch at adapter to "+" position, **must** be installed on **24 V UC** input (A1/A2).

Example of use



Dimensional drawing

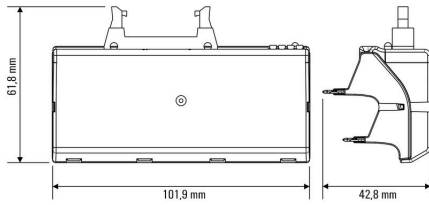

Dimensional drawing

Mounting adapter on input of TERMSERIES socket

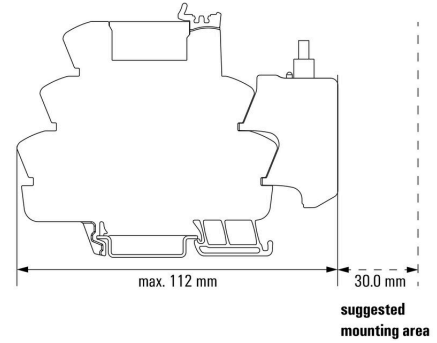

Mounting of the adapter on the input side of the TERMSERIES socket

Dimensional drawing

Mounting adapter on output of TERMSERIES socket

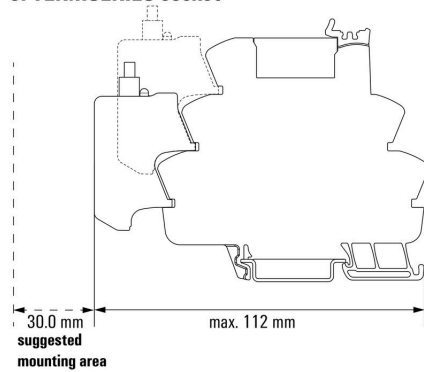

Mounting of the adapter on the output side of the TERMSERIES socket

Miscellaneous

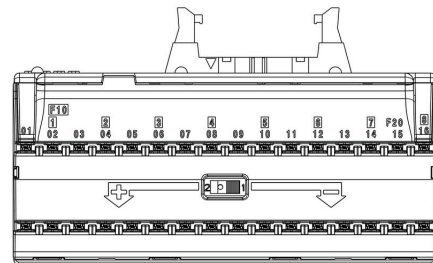

Front view

TIAL F20

Weidmüller Interface GmbH & Co. KG
Klingenbergstraße 26
D-32758 Detmold
Germany

Drawings

www.weidmueller.com

Miscellaneous

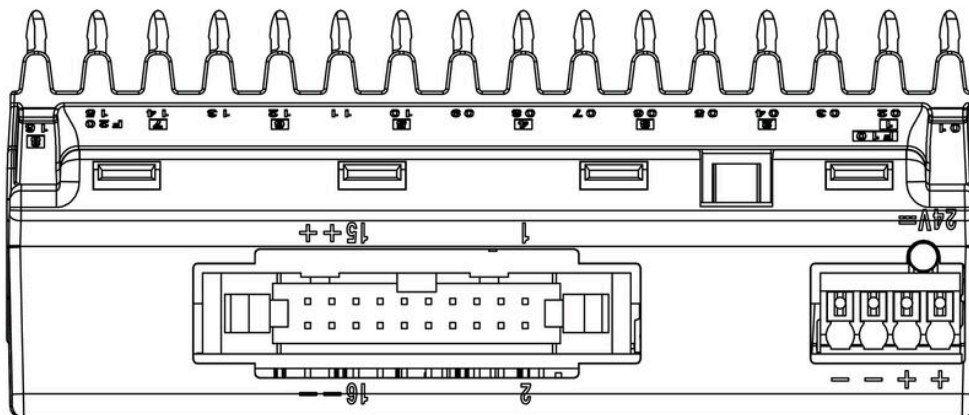

Top view

Miscellaneous

Type code TERMSERIES accessories

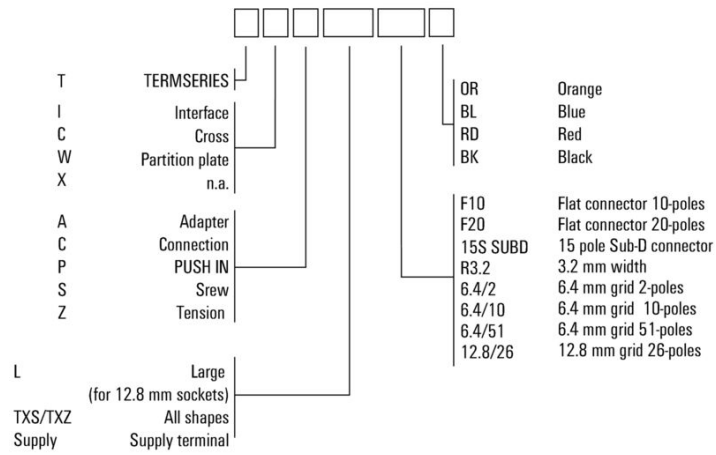

Type codes

TIAL F20

Weidmüller Interface GmbH & Co. KG

Klingenbergstraße 26

D-32758 Detmold

Germany

Accessories

www.weidmueller.com

Blank

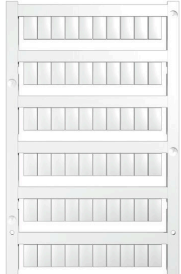

WS markers are the perfect match for the W-series connectors. Thanks to their system compatibility, the WS tags can also be used with the I-series and the Z-series. The large marking surfaces do not only permit long character strings but also multi-line text. WS markers are ideal for labels with long, customised character strings. Thanks to the proven MultiCard format, printing with PrintJet CONNECT oder/or Plotter is possible.

- Can be fitted in strips or individually
- Markers in proven MultiCard format

For custom printing: Please send us a file of our labeling software M-Print PRO or M-Print PRO Online (without installation) for your labeling specifications.

General ordering data

Type	WS 10/6 MC M NE GE	Version
Order No.	1917430000	WS, Terminal marker, 10 x 6 mm, Pitch in mm (P): 6.00 Weidmueller,
GTIN (EAN)	4032248551637	Allen-Bradley, yellow
Qty.	600 ST	
Type	WS 10/6 MC M NE GN	Version
Order No.	1917420000	WS, Terminal marker, 10 x 6 mm, Pitch in mm (P): 6.00 Weidmueller,
GTIN (EAN)	4032248551620	Allen-Bradley, green
Qty.	600 ST	
Type	WS 10/6 M MC NE WS	Version
Order No.	1818400000	WS, Terminal marker, 10 x 6 mm, Pitch in mm (P): 6.00 Weidmueller,
GTIN (EAN)	4032248310876	Allen-Bradley, white
Qty.	600 ST	
Type	WS 10/6 MC NE WS	Version
Order No.	1828450000	WS, Terminal marker, 10 x 6 mm, Pitch in mm (P): 6.00 Weidmueller,
GTIN (EAN)	4032248350513	Allen-Bradley, white
Qty.	600 ST	
Type	WS 12/6 MC NE BL	Version
Order No.	1773551693	WS, Terminal marker, 12 x 6 mm, Pitch in mm (P): 6.00 Weidmueller,
GTIN (EAN)	4032248143269	Allen-Bradley, blue
Qty.	600 ST	
Type	WS 12/6 MC NE GE	Version
Order No.	1773551687	WS, Terminal marker, 12 x 6 mm, Pitch in mm (P): 6.00 Weidmueller,
GTIN (EAN)	4032248141937	Allen-Bradley, yellow
Qty.	600 ST	
Type	WS 12/6 MC NE RT	Version
Order No.	1773551686	WS, Terminal marker, 12 x 6 mm, Pitch in mm (P): 6.00 Weidmueller,
GTIN (EAN)	4032248141920	Allen-Bradley, red
Qty.	600 ST	
Type	WS 12/6 MC NE WS	Version
Order No.	1609900000	WS, Terminal marker, 12 x 6 mm, Pitch in mm (P): 6.00 Weidmueller,
GTIN (EAN)	4008190203467	Allen-Bradley, white
Qty.	600 ST	

TIAL F20**Weidmüller Interface GmbH & Co. KG**Klingenbergstraße 26
D-32758 Detmold
Germany**Accessories**

www.weidmueller.com

WS 12/6**WS/ DEK**

MultiMark terminal markers use an innovative composite material made from two components. The hard base contour of the marker snaps securely into the connector. The elastic surface finish makes the marker easy to mount. This specially punched material enables the strips to be stretched to accommodate the slight variations in spacing that tend to add up, especially with long terminal blocks. Another advantage: the excellent printability of the surface material guarantees durable and wear-resistant labelling. A print resolution of 300 dpi also produces a very legible script.

Your benefits with MultiMark

- Firm hold and durable printing
- Continuous strips save installation time
- Easy mounting thanks to an innovative composite material
- Large label field for optimal legibility
- High flexibility thanks to manufacturer independence

General ordering data

Type	WS 12/6 MM WS	Version	
Order No.	2007200000		WS, Terminal marker, 12 x 6 mm, Weidmueller, white
GTIN (EAN)	4050118391886		
Qty.	600 ST		