

LMF 5.08/12/180 3.5SN BK BX

Weidmüller Interface GmbH & Co. KG
 Klingenbergstraße 26
 D-32758 Detmold
 Germany

www.weidmueller.com

Product image

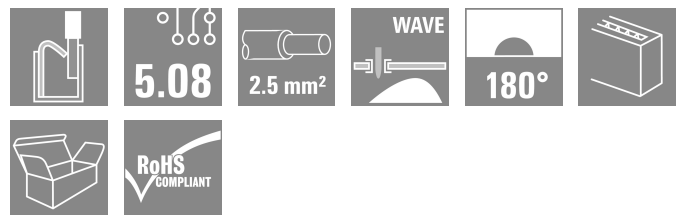
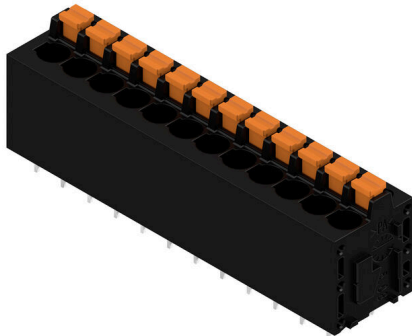

The new LMF allows us to meet the current market requirements for a PCB terminal with PUSH IN connection system for wire cross-sections up to 2.5 mm²

- PUSH IN connection system
- LMF with pusher for opening the terminal point
- LMFS without pusher, the terminal point is opened with a screwdriver
- Integrated test point
- 90° and 180° wire outlet direction

General ordering data

Version	Printed circuit board terminals, 5.08 mm, Number of poles: 12, 180°, Solder pin length (l): 3.5 mm, tinned, black, PUSH IN with push button, Clamping range, max. : 2.5 mm ² , Box
Order No.	1426170000
Type	LMF 5.08/12/180 3.5SN BK BX
GTIN (EAN)	4050118230215
Qty.	25 items
Product data	IEC: 400 V / 24 A / 0.5 - 2.5 mm ² UL: 300 V / 20 A / AWG 24 - AWG 12
Packaging	Box

LMF 5.08/12/180 3.5SN BK BX

Weidmüller Interface GmbH & Co. KG
Klingenbergstraße 26
D-32758 Detmold
Germany

www.weidmueller.com

Technical data

Approvals

ROHS	Conform
------	---------

Dimensions and weights

Depth	14.8 mm	Depth (inches)	0.5827 inch
Height	22.7 mm	Height (inches)	0.8937 inch
Height of lowest version	19.2 mm	Width	63.58 mm
Width (inches)	2.5031 inch	Net weight	18.22 g

Environmental Product Compliance

RoHS Compliance Status	Compliant without exemption
REACH SVHC	No SVHC above 0.1 wt%

System parameters

Product family	OMNIMATE Signal - series LMF	Wire connection method	PUSH IN with push button
Mounting onto the PCB	THT solder connection	Conductor outlet direction	180°
Pitch in mm (P)	5.08 mm	Pitch in inches (P)	0.200 "
Number of poles	12	Pin series quantity	2
Fitted by customer	No	Number of rows	1
Max. adjacent poles per row	24	Solder pin length (l)	3.5 mm
Solder pin dimensions	d = 0.8 mm	Solder eyelet hole diameter (D)	1.1 mm
Solder eyelet hole diameter tolerance (D)+	0, 1 mm	Number of solder pins per pole	2
Screwdriver blade	0.6 x 3.5	Screwdriver blade standard	DIN 5264
Stripping length	10 mm	L1 in mm	55.88 mm
L1 in inches	2.200 "	Touch-safe protection acc. to DIN VDE 0470	IP 20
Touch-safe protection acc. to DIN VDE 57 106	Safe from finger touch	Protection degree	IP20

Material data

Insulating material	Wemid (PA)	Colour	black
Colour of operational elements	orange	Colour chart (similar)	RAL 9011
Comparative Tracking Index (CTI)	≥ 600	Moisture Level (MSL)	
UL 94 flammability rating	V-0	Contact material	Cu-alloy
Contact surface	tinned	Coating	4-6 µm SN
Tinning type	matt	Layer structure of solder connection	4...6 mm Sn matt
Storage temperature, min.	-40 °C	Storage temperature, max.	70 °C
Operating temperature, min.	-50 °C	Operating temperature, max.	120 °C
Temperature range, installation, min.	-25 °C	Temperature range, installation, max.	120 °C

Conductors suitable for connection

Clamping range, min.	0.12 mm ²
Clamping range, max.	2.5 mm ²
Wire connection cross section AWG, min.	AWG 24
Wire connection cross section AWG, max.	AWG 12
Solid, min. H05(07) V-U	0.5 mm ²
Solid, max. H05(07) V-U	2.5 mm ²
Flexible, min. H05(07) V-K	0.25 mm ²
Flexible, max. H05(07) V-K	2.5 mm ²

LMF 5.08/12/180 3.5SN BK BX

Weidmüller Interface GmbH & Co. KG
 Klingenbergstraße 26
 D-32758 Detmold
 Germany

www.weidmueller.com

Technical data

w. plastic collar ferrule, DIN 46228 pt 4, 0.25 mm²
 min.

w. plastic collar ferrule, DIN 46228 pt 4, 2.5 mm²
 max.

w. wire end ferrule, DIN 46228 pt 1, 0.25 mm²
 min.

w. wire end ferrule, DIN 46228 pt 1, 2.5 mm²
 max.

Plug gauge in accordance with EN 60999 a x b; ø 2.4 mm x 1.5 mm

Clampable conductor	Cross-section for conductor connection	Type	fine-wired
		nominal	0.5 mm ²
wire end ferrule	wire end ferrule	Stripping length	nominal 12 mm
		Recommended wire-end ferrule	H0.5/16 OR
		Stripping length	nominal 10 mm
		Recommended wire-end ferrule	H0.5/10
Cross-section for conductor connection	Type	fine-wired	
	nominal	0.75 mm ²	
wire end ferrule	wire end ferrule	Stripping length	nominal 12 mm
		Recommended wire-end ferrule	H0.75/16 W
		Stripping length	nominal 10 mm
		Recommended wire-end ferrule	H0.75/10
Cross-section for conductor connection	Type	fine-wired	
	nominal	1 mm ²	
wire end ferrule	wire end ferrule	Stripping length	nominal 12 mm
		Recommended wire-end ferrule	H1.0/16D R
		Stripping length	nominal 10 mm
		Recommended wire-end ferrule	H1.0/10
Cross-section for conductor connection	Type	fine-wired	
	nominal	1.5 mm ²	
wire end ferrule	wire end ferrule	Stripping length	nominal 10 mm
		Recommended wire-end ferrule	H1.5/10
		Stripping length	nominal 12 mm
		Recommended wire-end ferrule	H1.5/16 R
Cross-section for conductor connection	Type	fine-wired	
	nominal	2.5 mm ²	
wire end ferrule	wire end ferrule	Stripping length	nominal 10 mm
		Recommended wire-end ferrule	H2.5/10

Reference text Length of ferrules is to be chosen depending on the product and the rated voltage., The outside diameter of the plastic collar should not be larger than the pitch (P)

Rated data acc. to IEC

tested acc. to standard	IEC 60664-1, IEC 60947-7-4	Rated current, min. number of poles (Tu=20°C)	24 A
Rated current, max. number of poles (Tu=20°C)	24 A	Rated current, min. number of poles (Tu=40°C)	24 A
Rated current, max. number of poles (Tu=40°C)	24 A	Rated voltage for surge voltage class / pollution degree II/2	400 V
Rated voltage for surge voltage class / pollution degree III/2	320 V	Rated voltage for surge voltage class / pollution degree III/3	250 V

LMF 5.08/12/180 3.5SN BK BX

Weidmüller Interface GmbH & Co. KG
 Klingenbergstraße 26
 D-32758 Detmold
 Germany

www.weidmueller.com

Technical data

Rated impulse voltage for surge voltage class/ pollution degree II/2 4 kV

Rated impulse voltage for surge voltage class/ contamination degree III/3 4 kV

Rated impulse voltage for surge voltage class/ pollution degree III/2 4 kV

Short-time withstand current resistance 3 x 1s with 120 A

Rated data acc. to CSA

Rated voltage (Use group B / CSA) 300 V

Rated current (Use group B / CSA) 20 A

Wire cross-section, AWG, min. AWG 24

Rated voltage (Use group D / CSA) 300 V

Rated current (Use group D / CSA) 10 A

Wire cross-section, AWG, max. AWG 12

Rated data acc. to UL 1059

Rated voltage (Use group B / UL 1059) 300 V

Rated current (Use group B / UL 1059) 20 A

Wire cross-section, AWG, min. AWG 24

Rated voltage (Use group D / UL 1059) 300 V

Rated current (Use group D / UL 1059) 10 A

Wire cross-section, AWG, max. AWG 12

Packing

Packaging Box VPE length 348.00 mm

VPE width 138.00 mm VPE height 31.00 mm

Type tests

Test: Durability of markings	Standard	IEC 61984 section 6.2 and 7.3.2 / 10.11		
	Test	mark of origin, type identification, type of material, approval marking UL, approval marking CSA, durability, pitch, date clock		
	Evaluation	available		
Test: Clampable cross section	Standard	IEC 60999-1 section 7 and 9.1 / 11.99, IEC 60947-1 section 8.2.4.5.1 / 03.11		
	Conductor type	Type of conductor and conductor cross-section	solid 0,12 mm ²	
		Type of conductor and conductor cross-section	flexible 0,12 mm ²	
		Type of conductor and conductor cross-section	solid 2.5 mm ²	
		Type of conductor and conductor cross-section	stranded 2.5 mm ²	
		Type of conductor and conductor cross-section	AWG 26/1	
		Type of conductor and conductor cross-section	AWG 26/19	
		Type of conductor and conductor cross-section	AWG 14/1	
		Type of conductor and conductor cross-section	AWG 12/19	
Evaluation	passed			
Test for damage to and accidental loosening of conductors	Standard	IEC 60999-1 section 9.4 / 11.99		
	Requirement	0.2 kg		
	Conductor type	Type of conductor and conductor cross-section	stranded 0.25 mm ²	

LMF 5.08/12/180 3.5SN BK BX

Weidmüller Interface GmbH & Co. KG
 Klingenbergstraße 26
 D-32758 Detmold
 Germany

www.weidmueller.com

Technical data

	Type of conductor and conductor cross-section	AWG 26/1
	Type of conductor and conductor cross-section	AWG26/19
Evaluation	passed	
Requirement	0.3 kg	
Conductor type	Type of conductor and conductor cross-section	H05V-U0.5
	Type of conductor and conductor cross-section	H05V-K0.5
Evaluation	passed	
Requirement	0.7 kg	
Conductor type	Type of conductor and conductor cross-section	H07V-U2.5
	Type of conductor and conductor cross-section	H07V-K2.5
	Type of conductor and conductor cross-section	AWG 14/1
Evaluation	passed	
Requirement	0.9 kg	
Conductor type	Type of conductor and conductor cross-section	AWG 12/19
Evaluation	passed	
Standard	IEC 60999-1 section 9.5 / 11.99	
Requirement	≥10 N	
Conductor type	Type of conductor and conductor cross-section	AWG 26/1
	Type of conductor and conductor cross-section	AWG 26/19
Evaluation	passed	
Requirement	≥15 N	
Conductor type	Type of conductor and conductor cross-section	stranded 0.25 mm ²
Evaluation	passed	
Requirement	≥20 N	
Conductor type	Type of conductor and conductor cross-section	H05V-U0.5
	Type of conductor and conductor cross-section	H05V-K0.5
Evaluation	passed	
Requirement	≥50 N	
Conductor type	Type of conductor and conductor cross-section	H07V-U2.5
	Type of conductor and conductor cross-section	H07V-K2.5
	Type of conductor and conductor cross-section	AWG 14/1

Pull-out test

LMF 5.08/12/180 3.5SN BK BX

Weidmüller Interface GmbH & Co. KG
 Klingenbergstraße 26
 D-32758 Detmold
 Germany

www.weidmueller.com

Technical data

Evaluation	passed
Requirement	≥60 N
Conductor type	Type of conductor and conductor cross-section AWG 12/19
Evaluation	passed

Important note

IPC conformity	Conformity: The products are developed, manufactured and delivered according international recognized standards and norms and comply with the assured properties in the data sheet resp. fulfill decorative properties in accordance with IPC-A-610 "Class 2". Further claims on the products can be evaluated on request.
Notes	<ul style="list-style-type: none"> • Additional variants on request • Rated current related to rated cross-section & min. No. of poles. • Wire end ferrule without plastic collar to DIN 46228/1 • Wire end ferrule with plastic collar to DIN 46228/4 • P on drawing = pitch • Rated data refer only to the component itself. Clearance and creepage distances to other components are to be designed in accordance with the relevant application standards. • The test point can only be used as potential-pickup point. • Long term storage of the product with average temperature of 50 °C and maximum humidity 70%, 36 months

Classifications

ETIM 8.0	EC002643	ETIM 9.0	EC002643
ETIM 10.0	EC002643	ECLASS 14.0	27-46-01-01
ECLASS 15.0	27-46-01-01		

LMF 5.08/12/180 3.5SN BK BX

Weidmüller Interface GmbH & Co. KG
 Klingenbergstraße 26
 D-32758 Detmold
 Germany

www.weidmueller.com

Drawings

Product image

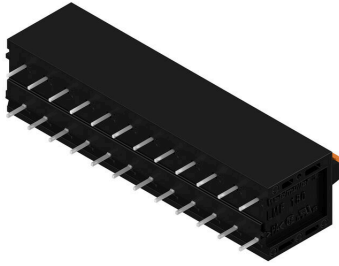

Dimensional drawing

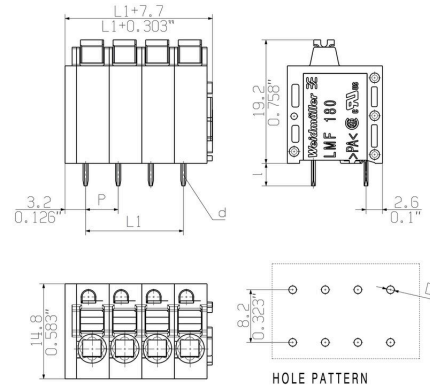

Graph

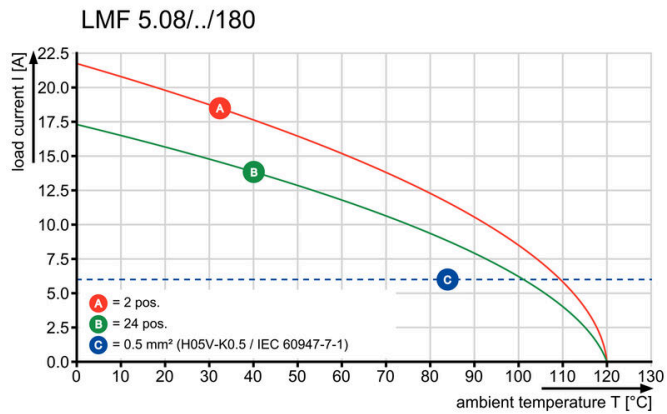

Graph

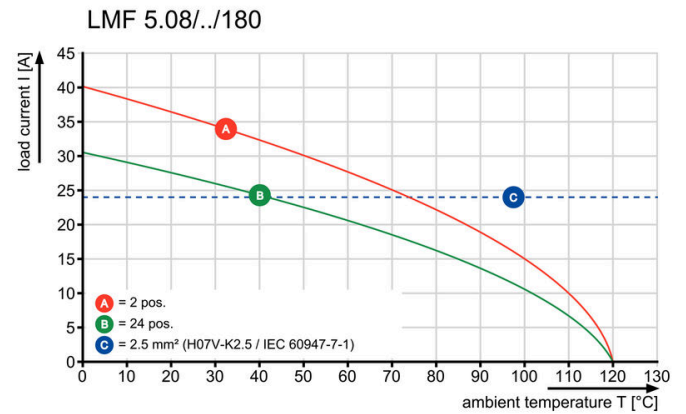

Drawings

Product benefits

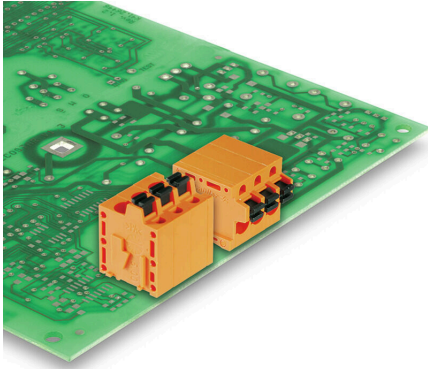

Optional conductor outlet
directionStable mechanical design

Product benefits

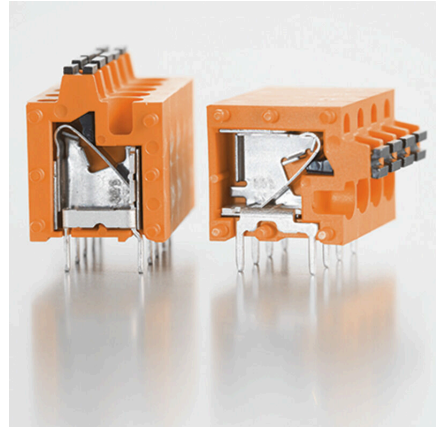

High reliability of the current capacity

Product benefits

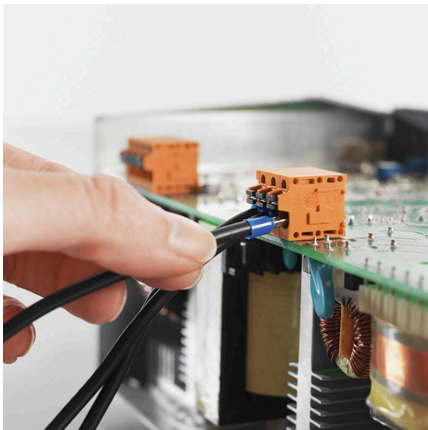

Direct conductor entryCross section up to 2.5 mm²

Product benefits

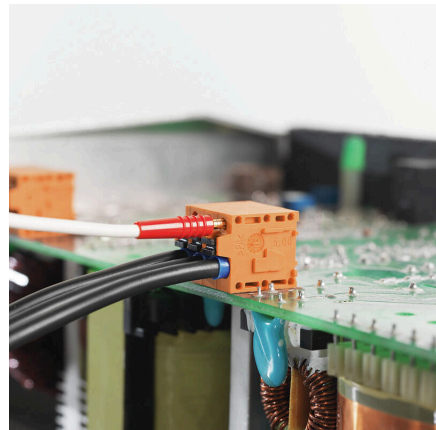

Maintenance through test point