

IE-AD-M12XRJ45-180

Weidmüller Interface GmbH & Co. KG
Klingenbergstraße 26
D-32758 Detmold
Germany

www.weidmueller.com



General ordering data

Version	Adapter, RJ45, M12, Cat.6A / Class EA (ISO/IEC 11801 2010), IP67, M12 socket to RJ45 socket
Order No.	1400620000
Type	IE-AD-M12XRJ45-180
GTIN (EAN)	4050118202526
Qty.	1 items

IE-AD-M12XRJ45-180

Weidmüller Interface GmbH & Co. KG
Klingenbergstraße 26
D-32758 Detmold
Germany

www.weidmueller.com

Technical data

Approvals

Approvals



ROHS Conform

UL File Number Search [UL Website](#)

Certificate no. (cULus) E471884

Dimensions and weights

Wall thickness, min.	0.9 mm	Wall thickness, max.	3 mm
Net weight	40.48 g		

Temperatures

Storage temperature	Operating temperature	-25 °C...85 °C
Installation temperature		

Environmental Product Compliance

RoHS Compliance Status	Compliant with exemption
RoHS Exemption (if applicable/known)	6c
REACH SVHC	Lead 7439-92-1
SCIP	67cf1078-beca-4687-860b-dc475a6ec24a

Technical data customisable plug-in connectors

Number of poles	8	Coding	X-coded
Contact surface	Gold-plated	Housing main material	Zinc diecast
Insulation resistance	100 MΩ	Category	Cat.6A / Class EA (ISO/IEC 11801 2010)
Contact material	Copper alloy	Nominal voltage	50 V
Protection degree	IP67	Plugging cycles	≥ 100 (M12), 750 (RJ45)

General Info

Number of poles	8	Connection 1	RJ45
Connection 2	M12	Description of article	Adapter, straight
Composition	M12 socket to RJ45 socket	Housing main material	Zinc diecast
Category	Cat.6A / Class EA (ISO/IEC 11801 2010)	Connection thread	M12
Contact material	Copper alloy	Contact surface	Gold-plated
Shielding	360° shield contact	Protection degree	IP67
Plugging cycles	≥ 100 (M12), 750 (RJ45)		

Electrical properties

Insulation resistance	100 MΩ	Nominal voltage	50 V
-----------------------	--------	-----------------	------

Standards

Connector standard	IEC 61076-2-109, IEC 60603-7-51
--------------------	---------------------------------

IE-AD-M12XRJ45-180

Weidmüller Interface GmbH & Co. KG
Klingenbergstraße 26
D-32758 Detmold
Germany

www.weidmueller.com

Technical data**General technical specifications**

Number of poles	8	Coding	X-coded
Connection thread	M12	Contact surface	Gold-plated
Housing main material	Zinc diecast	Insulation resistance	100 MΩ
Contact material	Copper alloy	Nominal voltage	50 V
Protection degree	IP67	Plugging cycles	≥ 100 (M12), 750 (RJ45)

Classifications

ETIM 8.0	EC000313	ETIM 9.0	EC000313
ETIM 10.0	EC000313	ECLASS 14.0	27-44-03-20
ECLASS 15.0	27-44-03-20		

Dimensioned drawing

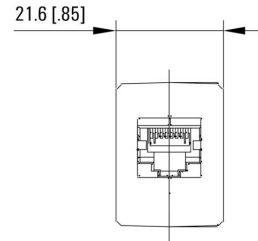

Dimensioned drawing

Dimensioned drawing

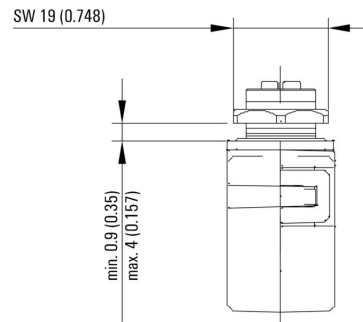
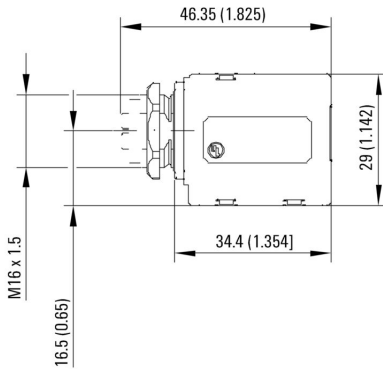

Installation cut-out

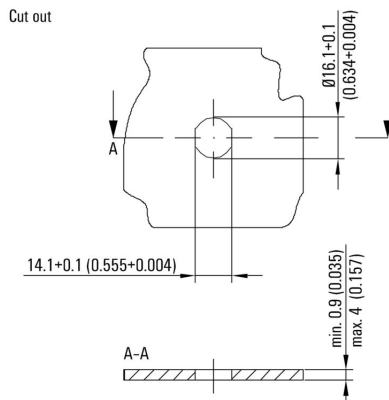

IE-AD-M12XRJ45-180

Weidmüller Interface GmbH & Co. KG
Klingenbergstraße 26
D-32758 Detmold
Germany

Drawings

www.weidmueller.com

Wiring



IE-AD-M12XRJ45-180

Weidmüller Interface GmbH & Co. KG
 Klingenbergstraße 26
 D-32758 Detmold
 Germany

www.weidmueller.com

Accessories

Screwty® cable gland tool



The ideal tool for any application
 Screwty® is the ideal, all-purpose tool for tightening all common sensor and actuator cables. Even difficult-to-reach round plugs are accessible using the Screwty®. A simple turning movement tightens and loosens the connectors without the need for excessive force. The Screwty® is a unique and global solution since it fits with most cables and plugs from other vendors (over 90 %). The Screwty® consists of a handle with a conventional 1/4" adapter. Thus it can be used for all sizes: for M12 and M8 round plug-in connectors, and for M12F and M8F customisable plugs and sockets, as well as for all M23 plugs and sockets.

General ordering data

Type	SCREWTY SET	Version	
Order No.	1910000000		Cable gland tool for M8, M12 lines and connectors
GTIN (EAN)	4032248436842		
Qty.	1 ST		

Screwty® cable gland tool with torque function



The ideal tool for any application
 Screwty® is the ideal, all-purpose tool for tightening all common sensor and actuator cables. Even difficult-to-reach round plugs are accessible using the Screwty®. A simple turning movement tightens and loosens the connectors without the need for excessive force. The Screwty® is a unique and global solution since it fits with most cables and plugs from other vendors (over 90 %). The Screwty® consists of a handle with a conventional 1/4" adapter. Thus it can be used for all sizes: for M12 and M8 round plug-in connectors, and for M12F and M8F customisable plugs and sockets, as well as for all M23 plugs and sockets.

General ordering data

Type	SCREWTY SET -DM	Version	
Order No.	1920000000		Cable gland tool for M8, M12 lines and connectors
GTIN (EAN)	4032248436859		
Qty.	1 ST		

IE-AD-M12XRJ45-180

Weidmüller Interface GmbH & Co. KG
 Klingenbergstraße 26
 D-32758 Detmold
 Germany

www.weidmueller.com

Accessories

Screwty® cable gland tool



The ideal tool for any application
 Screwty® is the ideal, all-purpose tool for tightening all common sensor and actuator cables. Even difficult-to-reach round plugs are accessible using the Screwty®. A simple turning movement tightens and loosens the connectors without the need for excessive force. The Screwty® is a unique and global solution since it fits with most cables and plugs from other vendors (over 90 %). The Screwty® consists of a handle with a conventional 1/4" adapter. Thus it can be used for all sizes: for M12 and M8 round plug-in connectors, and for M12F and M8F customisable plugs and sockets, as well as for all M23 plugs and sockets.

General ordering data

Type	SCREWTY- M12 F	Version	
Order No.	1900020000		Cable gland tool for M12 connectors
GTIN (EAN)	4032248375851		
Qty.	1 ST		

Screwty® cable gland tool with torque function



The ideal tool for any application
 Screwty® is the ideal, all-purpose tool for tightening all common sensor and actuator cables. Even difficult-to-reach round plugs are accessible using the Screwty®. A simple turning movement tightens and loosens the connectors without the need for excessive force. The Screwty® is a unique and global solution since it fits with most cables and plugs from other vendors (over 90 %). The Screwty® consists of a handle with a conventional 1/4" adapter. Thus it can be used for all sizes: for M12 and M8 round plug-in connectors, and for M12F and M8F customisable plugs and sockets, as well as for all M23 plugs and sockets.

General ordering data

Type	SCREWTY-M12 F-DM	Version	
Order No.	1900021000		Cable gland tool for M12 connectors
GTIN (EAN)	4032248436828		
Qty.	1 ST		