

SAI-WDF-4P-M8

Weidmüller Interface GmbH & Co. KG
Klingenbergstraße 26
D-32758 Detmold
Germany

www.weidmueller.com



General ordering data

Order No.	1392400000
Type	SAI-WDF-4P-M8
GTIN (EAN)	4050118192773
Qty.	1 items

SAI-WDF-4P-M8

Weidmüller Interface GmbH & Co. KG
 Klingenbergstraße 26
 D-32758 Detmold
 Germany

www.weidmueller.com

Technical data

Approvals

Approvals



ROHS Conform

Dimensions and weights

Net weight 23 g

Environmental Product Compliance

RoHS Compliance Status	Compliant with exemption
RoHS Exemption (if applicable/known)	6c
REACH SVHC	Lead 7439-92-1
SCIP	ebf89fc8-a87f-4691-b87a-dfb9921774b4

Technical data customisable plug-in connectors

Number of poles	4	Coding	M8 = none
Contact surface	Gold-plated	Housing main material	CuZn
Contact material	CuZn	Nominal voltage	30 V
Nominal current	4 A	Protection degree	IP67
Temperature range of housing	-40 ... +85 °C		

General technical specifications

Number of poles	4	Coding	M8 = none
Connection thread	M8 socket, M8 pin	Contact surface	Gold-plated
Housing main material	CuZn	Contact material	CuZn
Nominal voltage	30 V	Nominal current	4 A
Protection degree	IP67	Temperature range of housing	-40 ... +85 °C

Classifications

ETIM 8.0	EC002925	ETIM 9.0	EC002925
ETIM 10.0	EC002925	ECLASS 14.0	27-44-01-06
ECLASS 15.0	27-44-01-06		

SAI-WDF-4P-M8

Weidmüller Interface GmbH & Co. KG
 Klingenbergstraße 26
 D-32758 Detmold
 Germany

www.weidmueller.com

Drawings

Dimensioned drawing

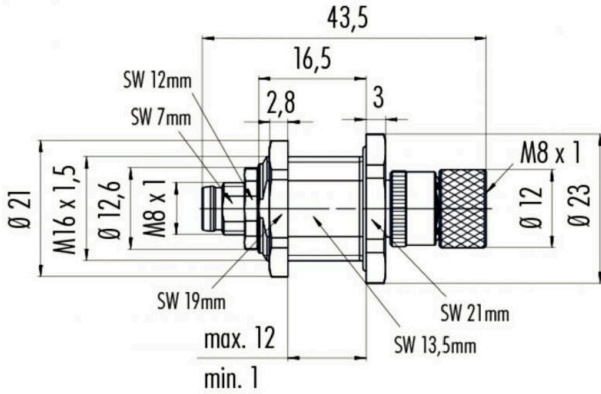

Wiring diagram

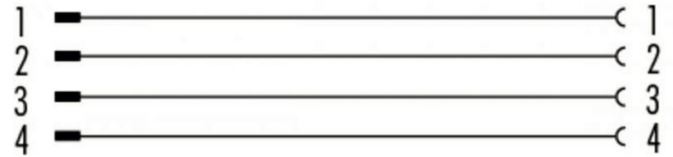

Pole scheme

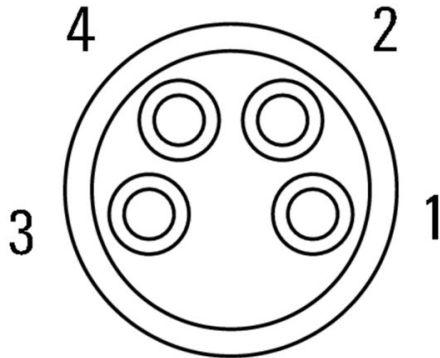

Pole scheme

