

## LXXX 15.00/08/90 4.5SN BK BX

**Weidmüller Interface GmbH & Co. KG**  
 Klingenbergstraße 26  
 D-32758 Detmold  
 Germany

www.weidmueller.com

### Product image

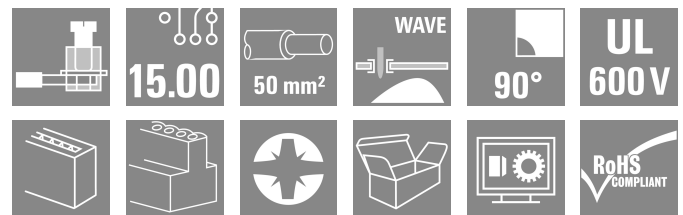

The high-current PCB connection for more power on board: 150 A / 1000 V with wires up to 50 mm<sup>2</sup>, transmitted right to the PCB!

The LXXX 15.0 – with its proven steel clamping-yoke technology in a compact standard housing – integrates the latest market requirements for security, power density and miniaturization in power electronics. It connects these requirements into an efficient solution for the entire value-creation chain – including development, production, installation and maintenance.

The function and form of the application's connection method plays a key role. It influences the application's design, reliability, usability and costs. With the Substitution of

For example, with the replacement of complex constructions involving bolts or bus bars, the PCB can be transformed into a system platform that is both consistent and sustainable into the future – even for high-current applications.

The LXXX 15.0 reduces size and complexity while at the same time improving application integration. In so doing, it fulfils the requirements of power electronics better than the established mechanisms and connection elements.

### General ordering data

|              |   |
|--------------|---|
| Version      | Printed circuit board terminals, 15.00 mm, Number of poles: 8, 90°, Solder pin length (l): 4.5 mm, tinned, black, Clamping yoke connection, Clamping range, max. : 50 mm <sup>2</sup> , Box |
| Order No.    | <a href="#">1386700000</a>  |
| Type         | LXXX 15.00/08/90 4.5SN BK BX  |
| GTIN (EAN)   | 4050118187212   |
| Qty.         | 10 items  |
| Product data | IEC: 1000 V / 150 A / 0.5 - 50 mm <sup>2</sup><br>UL: 600 V / 126 A / AWG 20 - AWG 1  |
| Packaging    | Box   |

## LXXX 15.00/08/90 4.5SN BK BX

Weidmüller Interface GmbH & Co. KG  
Klingenbergstraße 26  
D-32758 Detmold  
Germany

www.weidmueller.com

## Technical data

## Approvals

Approvals



|                       |                            |
|-----------------------|----------------------------|
| ROHS                  | Conform                    |
| UL File Number Search | <a href="#">UL Website</a> |
| Certificate No. (UR)  | E60693                     |

## Dimensions and weights

|                          |             |                 |             |
|--------------------------|-------------|-----------------|-------------|
| Depth                    | 31 mm       | Depth (inches)  | 1.2205 inch |
| Height                   | 56 mm       | Height (inches) | 2.2047 inch |
| Height of lowest version | 51.5 mm     | Width           | 121 mm      |
| Width (inches)           | 4.7638 inch | Net weight      | 238.82 g    |

## Environmental Product Compliance

|                        |                             |
|------------------------|-----------------------------|
| RoHS Compliance Status | Compliant without exemption |
| REACH SVHC             | No SVHC above 0.1 wt%       |

## System parameters

|                                 |                                 |   |                          |
|---------------------------------|---------------------------------|---|--------------------------|
| Product family                  | OMNIMATE Power - series<br>LXXX | Wire connection method                        | Clamping yoke connection |
| Mounting onto the PCB           | THT solder connection           | Conductor outlet direction                    | 90°                      |
| Pitch in mm (P)                 | 15.00 mm                        | Pitch in inches (P)                           | 0.591 "                  |
| Number of poles                 | 8                               | Pin series quantity                           | 1                        |
| Fitted by customer              | No                              | Number of rows                                | 1                        |
| Solder pin length (l)           | 4.5 mm                          | Solder pin dimensions                         | 1.2 x 1.2 mm             |
| Solder eyelet hole diameter (D) | 1.6 mm                          | Solder eyelet hole diameter tolerance (D)+    | 0,1 mm                   |
| Number of solder pins per pole  | 4                               | Screwdriver blade                             | 1.2 x 6.5                |
| Screwdriver blade standard      | DIN 5264                        | Tightening torque, min.                       | 2.5 Nm                   |
| Tightening torque, max.         | 4 Nm                            | Clamping screw                                | M 6                      |
| Stripping length                | 18 mm                           | L1 in mm                                      | 105.00 mm                |
| L1 in inches                    | 4.136 "                         | Touch-safe protection acc. to DIN VDE<br>0470 | IP 20                    |
| Protection degree               | IP20                            |   |                          |

## Material data

|                                       |                                     |                                       |           |
|---------------------------------------|-------------------------------------|---------------------------------------|-----------|
| Insulating material                   | Wemid (PA)                          | Colour                                | black     |
| Colour chart (similar)                | RAL 9011                            | Insulating material group             | I         |
| Comparative Tracking Index (CTI)      | ≥ 600                               | Moisture Level (MSL)                  |           |
| UL 94 flammability rating             | V-0                                 | Contact material                      | Cu-alloy  |
| Contact surface                       | tinned                              | Coating                               | 4-6 µm SN |
| Layer structure of solder connection  | 1.5...3 µm Ni / 4...6 µm Sn<br>matt | Storage temperature, min.             | -40 °C    |
| Storage temperature, max.             | 70 °C                               | Operating temperature, min.           | -50 °C    |
| Operating temperature, max.           | 120 °C                              | Temperature range, installation, min. | -25 °C    |
| Temperature range, installation, max. | 120 °C                              |                                       |           |

## Conductors suitable for connection

|                      |                     |
|----------------------|---------------------|
| Clamping range, min. | 0.5 mm <sup>2</sup> |
| Clamping range, max. | 50 mm <sup>2</sup>  |

## LXXX 15.00/08/90 4.5SN BK BX

**Weidmüller Interface GmbH & Co. KG**  
 Klingenbergstraße 26  
 D-32758 Detmold  
 Germany

www.weidmueller.com

### Technical data

|   |                     |
|---|---------------------|
| Wire connection cross section AWG, min.         | AWG 20              |
| Wire connection cross section AWG, max.         | AWG 1               |
| Solid, min. H05(07) V-U                         | 0.5 mm <sup>2</sup> |
| Solid, max. H05(07) V-U                         | 16 mm <sup>2</sup>  |
| Stranded, min. H07V-R                           | 6 mm <sup>2</sup>   |
| Stranded, max. H07V-R                           | 50 mm <sup>2</sup>  |
| Flexible, min. H05(07) V-K                      | 0.5 mm <sup>2</sup> |
| Flexible, max. H05(07) V-K                      | 35 mm <sup>2</sup>  |
| w. plastic collar ferrule, DIN 46228 pt 4, min. | 0.5 mm <sup>2</sup> |
| w. plastic collar ferrule, DIN 46228 pt 4, max. | 35 mm <sup>2</sup>  |
| w. wire end ferrule, DIN 46228 pt 1, min.       | 0.5 mm <sup>2</sup> |
| w. wire end ferrule, DIN 46228 pt 1, max.       | 35 mm <sup>2</sup>  |

| Clampable conductor                    | Cross-section for conductor connection | Type                                   | fine-wired                  |       |  |
|--|--|--|-----------------------------|-------|--|
|  |  | nominal                                | 2.5 mm <sup>2</sup>         |       |  |
| wire end ferrule                       |  | Stripping length                       | nominal                     | 20 mm |  |
|  |  | Recommended wire-end ferrule           | <a href="#">H2.5/25D BL</a> |       |  |
|  |  | Stripping length                       | nominal                     | 18 mm |  |
|  |  | Recommended wire-end ferrule           | <a href="#">H2.5/18</a>     |       |  |
| Cross-section for conductor connection |  | Type                                   | fine-wired                  |       |  |
|  |  | nominal                                | 4 mm <sup>2</sup>           |       |  |
|  |  | Stripping length                       | nominal                     | 20 mm |  |
|  |  | Recommended wire-end ferrule           | <a href="#">H4.0/26D GR</a> |       |  |
| wire end ferrule                       |  | Stripping length                       | nominal                     | 18 mm |  |
|  |  | Recommended wire-end ferrule           | <a href="#">H4.0/18</a>     |       |  |
|  |  | Cross-section for conductor connection |                             |       |  |
|  |  | Type                                   | fine-wired                  |       |  |
| wire end ferrule                       |  | nominal                                | 6 mm <sup>2</sup>           |       |  |
|  |  | Stripping length                       | nominal                     | 20 mm |  |
|  |  | Recommended wire-end ferrule           | <a href="#">H6.0/26 SW</a>  |       |  |
|  |  | Stripping length                       | nominal                     | 18 mm |  |
| Recommended wire-end ferrule           |  | Recommended wire-end ferrule           | <a href="#">H6.0/18</a>     |       |  |
|  |  | Cross-section for conductor connection |                             |       |  |
|  |  | Type                                   | fine-wired                  |       |  |
|  |  | nominal                                | 10 mm <sup>2</sup>          |       |  |
| wire end ferrule                       |  | Stripping length                       | nominal                     | 21 mm |  |
|  |  | Recommended wire-end ferrule           | <a href="#">H10.0/28 EB</a> |       |  |
|  |  | Stripping length                       | nominal                     | 18 mm |  |
|  |  | Recommended wire-end ferrule           | <a href="#">H10.0/18</a>    |       |  |
| Cross-section for conductor connection |  | Type                                   | fine-wired                  |       |  |
|  |  | nominal                                | 16 mm <sup>2</sup>          |       |  |
|  |  | Stripping length                       | nominal                     | 21 mm |  |
|  |  | Recommended wire-end ferrule           | <a href="#">H16.0/28 GN</a> |       |  |
| wire end ferrule                       |  | Stripping length                       | nominal                     | 18 mm |  |
|  |  | Recommended wire-end ferrule           | <a href="#">H16.0/18</a>    |       |  |
|  |  | Cross-section for conductor connection |                             |       |  |
|  |  | Type                                   | fine-wired                  |       |  |
| nominal                                | 1.5 mm <sup>2</sup>                    |  |                             |       |  |

## LXXX 15.00/08/90 4.5SN BK BX

**Weidmüller Interface GmbH & Co. KG**  
 Klingenbergstraße 26  
 D-32758 Detmold  
 Germany

www.weidmueller.com

## Technical data

|  |                              |                             |       |
|--|------------------------------|-----------------------------|-------|
| wire end ferrule                       | Stripping length             | nominal                     | 20 mm |
|  | Recommended wire-end ferrule | <a href="#">H1,5/24 R</a>   |       |
|  | Stripping length             | nominal                     | 18 mm |
|  | Recommended wire-end ferrule | <a href="#">H1,5/18</a>     |       |
| Cross-section for conductor connection | Type                         | fine-wired                  |       |
|  | nominal                      | 35 mm <sup>2</sup>          |       |
| wire end ferrule                       | Stripping length             | nominal                     | 19 mm |
|  | Recommended wire-end ferrule | <a href="#">H35,0/32D R</a> |       |
|  | Stripping length             | nominal                     | 18 mm |
|  | Recommended wire-end ferrule | <a href="#">H35,0/18</a>    |       |
| Cross-section for conductor connection | Type                         | fine-wired                  |       |
|  | nominal                      | 50 mm <sup>2</sup>          |       |
| wire end ferrule                       | Stripping length             | nominal                     | 18 mm |
|  | Recommended wire-end ferrule | <a href="#">H50,0/18</a>    |       |

Reference text Length of ferrules is to be chosen depending on the product and the rated voltage., The outside diameter of the plastic collar should not be larger than the pitch (P)

## Rated data acc. to IEC

|   |        |   |        |
|---|--------|---|--------|
| Rated current, min. number of poles (Tu=20°C)                         | 150 A  | Rated current, min. number of poles (Tu=40°C)                             | 150 A  |
| Rated voltage for surge voltage class / pollution degree II/2         | 1000 V | Rated voltage for surge voltage class / pollution degree III/2            | 1000 V |
| Rated voltage for surge voltage class / pollution degree III/3        | 1000 V | Rated impulse voltage for surge voltage class/ pollution degree II/2      | 8 kV   |
| Rated impulse voltage for surge voltage class/ pollution degree III/2 | 8 kV   | Rated impulse voltage for surge voltage class/ contamination degree III/3 | 8 kV   |

## Rated data acc. to CSA

|                                   |        |                                   |       |
|-----------------------------------|--------|-----------------------------------|-------|
| Rated voltage (Use group B / CSA) | 600 V  | Rated voltage (Use group C / CSA) | 600 V |
| Rated voltage (Use group D / CSA) | 600 V  | Rated current (Use group B / CSA) | 127 A |
| Rated current (Use group C / CSA) | 127 A  | Rated current (Use group D / CSA) | 5 A   |
| Wire cross-section, AWG, min.     | AWG 20 | Wire cross-section, AWG, max.     | AWG 1 |

## Rated data acc. to UL 1059

|                                       |        |                                       |        |
|---------------------------------------|--------|---------------------------------------|--------|
| Institute (UR)                        | UR     | Certificate No. (UR)                  | E60693 |
| Rated voltage (Use group B / UL 1059) | 600 V  | Rated voltage (Use group C / UL 1059) | 600 V  |
| Rated current (Use group B / UL 1059) | 126 A  | Rated current (Use group C / UL 1059) | 126 A  |
| Wire cross-section, AWG, min.         | AWG 20 | Wire cross-section, AWG, max.         | AWG 1  |

Reference to approval values Specifications are maximum values, details - see approval certificate.

## Packing

|           |           |            |           |
|-----------|-----------|------------|-----------|
| Packaging | Box       | VPE length | 338.00 mm |
| VPE width | 130.00 mm | VPE height | 54.00 mm  |

## Type tests

|                              |          |                          |
|------------------------------|----------|--------------------------|
| Test: Durability of markings | Standard | DIN EN 60512-1-1 / 01.03 |
|------------------------------|----------|--------------------------|

**Technical data**

|   |   |   |                              |
|---|---|---|------------------------------|
|   | Test  | mark of origin, type identification, type of material, pitch, date clock, approval marking CSA, approval marking UL, durability |                              |
|   | Evaluation                                    | available   |                              |
| Test: Clampable cross section                             | Standard                                      | DIN EN 60999-1 section 7 and 9.1 / 12.00, DIN EN 60947-1 section 8.2.4.5.1 / 12.02  |                              |
|   | Conductor type                                | Type of conductor and conductor cross-section   | solid 0.5 mm <sup>2</sup>    |
|   |   | Type of conductor and conductor cross-section   | stranded 0.5 mm <sup>2</sup> |
|   |   | Type of conductor and conductor cross-section   | solid 16 mm <sup>2</sup>     |
|   |   | Type of conductor and conductor cross-section   | flexible 35 mm <sup>2</sup>  |
|   |   | Type of conductor and conductor cross-section   | AWG 20/1                     |
|   |   | Type of conductor and conductor cross-section   | AWG 20/19                    |
|   |   | Type of conductor and conductor cross-section   | AWG 10/1                     |
|   |   | Type of conductor and conductor cross-section   | AWG 1/19                     |
|   |   | Type of conductor and conductor cross-section   | H07V-R50                     |
| Type of conductor and conductor cross-section             | H07V-K35                                      |   |                              |
|   | Evaluation                                    | passed  |                              |
| Test for damage to and accidental loosening of conductors | Standard                                      | DIN EN 60999-1 section 9.5 / 12.00  |                              |
|   | Requirement                                   | 0.3 kg  |                              |
|   | Conductor type                                | Type of conductor and conductor cross-section   | solid 0.5 mm <sup>2</sup>    |
|   |   | Type of conductor and conductor cross-section   | stranded 0.5 mm <sup>2</sup> |
|   |   | Type of conductor and conductor cross-section   | AWG 20/1                     |
|   |   | Type of conductor and conductor cross-section   | AWG 20/19                    |
|   |   | Evaluation  | passed                       |
|   | Requirement                                   | 1.4 kg  |                              |
|   | Conductor type                                | Type of conductor and conductor cross-section   | AWG 10/1                     |
|   |   | Evaluation  | passed                       |
| Requirement   | 2.0 kg  |   |                              |
| Conductor type  | Type of conductor and conductor cross-section | stranded 10 mm <sup>2</sup>   |                              |
|   | Evaluation                                    | passed  |                              |
| Requirement   | 8,6 kg  |   |                              |

**LXXX 15.00/08/90 4.5SN BK BX**

**Weidmüller Interface GmbH & Co. KG**  
 Klingenbergstraße 26  
 D-32758 Detmold  
 Germany

www.weidmueller.com

**Technical data**

|                |   |   |                              |  |
|----------------|---|---|------------------------------|--|
| Pull-out test  | Conductor type                                | Type of conductor and conductor cross-section | AWG 1/19                     |  |
|                | Evaluation                                    | not checked                                   |                              |  |
|                | Requirement                                   | 8,6 kg  |                              |  |
|                | Conductor type                                | Type of conductor and conductor cross-section | flexible 35 mm <sup>2</sup>  |  |
|                | Evaluation                                    | passed  |                              |  |
|                | Standard                                      | DIN EN 60999 section 8.5 / 04.94              |                              |  |
|                | Requirement                                   | ≥20 N   |                              |  |
|                | Conductor type                                | Type of conductor and conductor cross-section | solid 0.5 mm <sup>2</sup>    |  |
|                |   | Type of conductor and conductor cross-section | stranded 0.5 mm <sup>2</sup> |  |
|                |   | Type of conductor and conductor cross-section | AWG 20/1                     |  |
|                |   | Type of conductor and conductor cross-section | AWG 20/19                    |  |
|                | Evaluation                                    | passed  |                              |  |
|                | Requirement                                   | ≥80 N   |                              |  |
|                | Conductor type                                | Type of conductor and conductor cross-section | AWG 10/1                     |  |
|                | Evaluation                                    | passed  |                              |  |
|                | Requirement                                   | ≥ 90N   |                              |  |
|                | Conductor type                                | Type of conductor and conductor cross-section | stranded 10 mm <sup>2</sup>  |  |
|                | Evaluation                                    | passed  |                              |  |
| Requirement    | > 236 N                                       |   |                              |  |
| Conductor type | Type of conductor and conductor cross-section | AWG 1/19                                      |                              |  |
| Evaluation     | not checked                                   |   |                              |  |
| Requirement    | > 190 N                                       |   |                              |  |
| Conductor type | Type of conductor and conductor cross-section | flexible 35 mm <sup>2</sup>                   |                              |  |
| Evaluation     | passed  |   |                              |  |

**Important note**

**IPC conformity** Conformity: The products are developed, manufactured and delivered according international recognized standards and norms and comply with the assured properties in the data sheet resp. fulfill decorative properties in accordance with IPC-A-610 "Class 2". Further claims on the products can be evaluated on request.

- Notes**
- Additional variants on request
  - Rated current related to rated cross-section & min. No. of poles.
  - Wire end ferrule without plastic collar to DIN 46228/1
  - Wire end ferrule with plastic collar to DIN 46228/4
  - P on drawing = pitch
  - Rated data refer only to the component itself. Clearance and creepage distances to other components are to be designed in accordance with the relevant application standards.
  - IP 20 from 16 mm<sup>2</sup> to 50 mm<sup>2</sup>
  - The test point can only be used as potential-pickup point.
  - Wire-end ferrules are mandatory for stranded wires with more than 19 strands.
  - Long term storage of the product with average temperature of 50 °C and maximum humidity 70%, 36 months

**LXXX 15.00/08/90 4.5SN BK BX**

**Weidmüller Interface GmbH & Co. KG**  
Klingenbergstraße 26  
D-32758 Detmold  
Germany

[www.weidmueller.com](http://www.weidmueller.com)

**Technical data**

**Classifications**

|             |             |             |             |
|-------------|-------------|-------------|-------------|
| ETIM 8.0    | EC002643    | ETIM 9.0    | EC002643    |
| ETIM 10.0   | EC002643    | ECLASS 14.0 | 27-46-01-01 |
| ECLASS 15.0 | 27-46-01-01 |             |             |

**LXXX 15.00/08/90 4.5SN BK BX**

Weidmüller Interface GmbH & Co. KG  
 Klingenbergstraße 26  
 D-32758 Detmold  
 Germany

www.weidmueller.com

Drawings

Product image

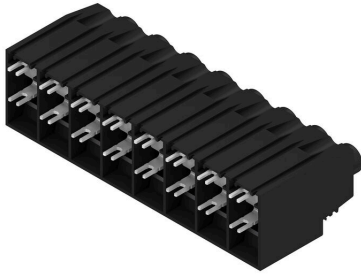

Dimensional drawing

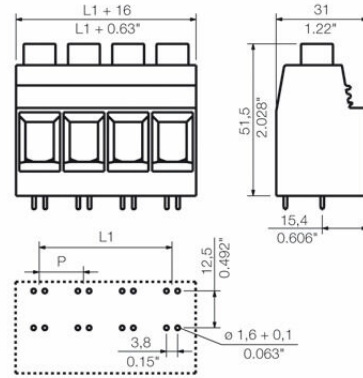

Graph

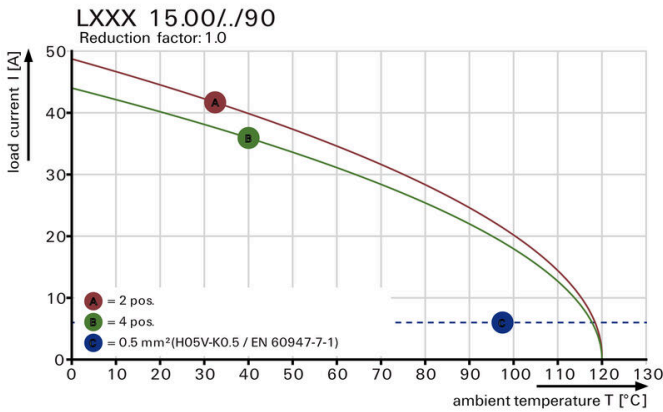

Graph

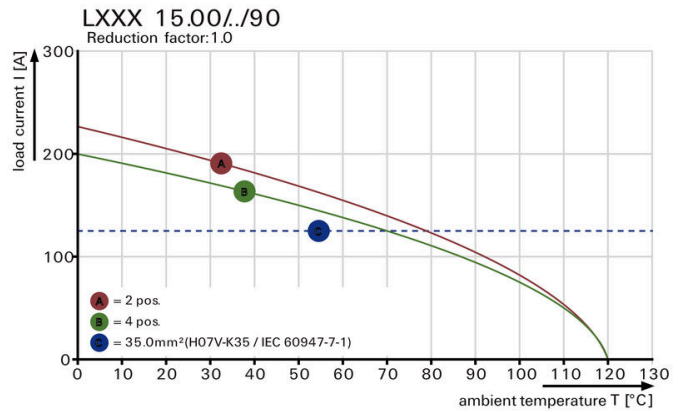

Graph

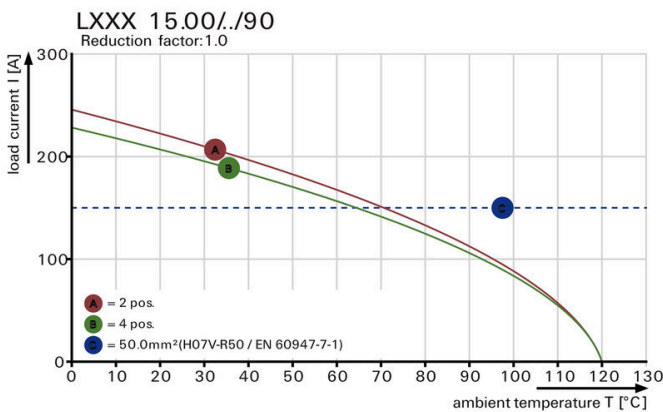

Product benefits

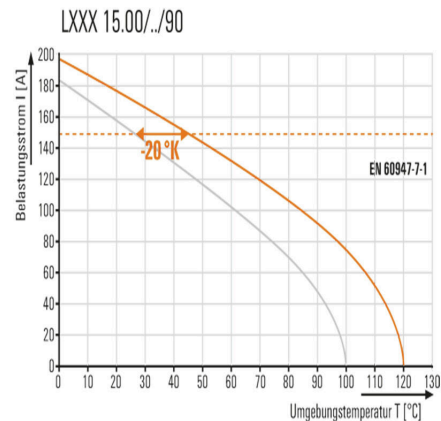

Increased power reserves Optimised application safety

**Drawings**



Standard-compliant integration