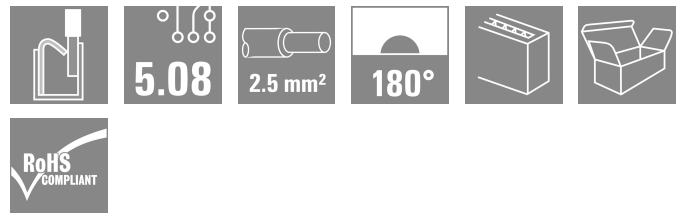
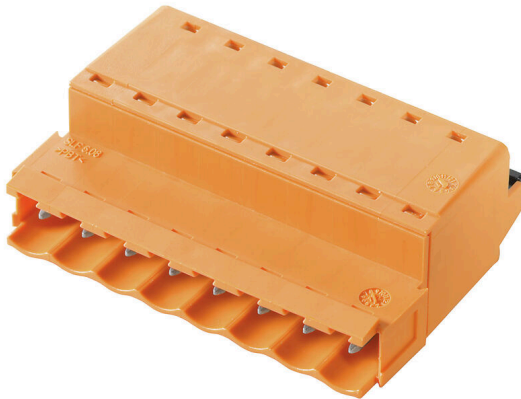

SLF 5.08/08/180B SN OR BX
Weidmüller Interface GmbH & Co. KG

 Klingenbergstraße 26
 D-32758 Detmold
 Germany

www.weidmueller.com

Male plug with PUSH IN wire connection and straight outlet direction, when used with BLF 5.08HC as wire-to-wire application for panel feed-through. The male plugs provide space for labelling and can be coded.

General ordering data

Version	PCB plug-in connector, male plug, 5.08 mm, Number of poles: 8, 180°, PUSH IN with actuator, Clamping range, max. : 3.31 mm², Box
Order No.	1335510000
Type	SLF 5.08/08/180B SN OR BX
GTIN (EAN)	4050118140125
Qty.	42 items
Product data	IEC: 400 V / 25.9 A / 0.2 - 2.5 mm² UL: 300 V / 14 A / AWG 26 - AWG 12
Packaging	Box

SLF 5.08/08/180B SN OR BX

Weidmüller Interface GmbH & Co. KG
Klingenbergstraße 26
D-32758 Detmold
Germany

www.weidmueller.com

Technical data

Approvals

Approvals



ROHS	Conform
UL File Number Search	UL Website
Certificate No. (cURus)	E60693

Dimensions and weights

Depth	30 mm	Depth (inches)	1.1811 inch
Height	14.2 mm	Height (inches)	0.5591 inch
Net weight	13.87 g		

Environmental Product Compliance

RoHS Compliance Status	Compliant without exemption
REACH SVHC	No SVHC above 0.1 wt%

System Parameters

Product family	OMNIMATE Signal - series BL/SL 5.08	Type of connection	Field connection
Wire connection method	PUSH IN with actuator	Pitch in mm (P)	5.08 mm
Pitch in inches (P)	0.200 "	Conductor outlet direction	180°
Number of poles	8	L1 in mm	35.56 mm
L1 in inches	1.400 "	Number of rows	1
Pin series quantity	1	Rated cross-section	2.5 mm ²
Touch-safe protection acc. to DIN VDE 0470	IP20 plugged/ IP10 unplugged	Protection degree	IP20
Volume resistance	≤5 mΩ	Can be coded	Yes
Stripping length	10 mm	Screwdriver blade	0.6 x 3.5
Screwdriver blade standard	DIN 5264	Plugging cycles	25
Plugging force/pole, max.	7 N	Pulling force/pole, max.	5.5 N

Material data

Insulating material	PBT	Colour	orange
Colour of operational elements	black	Colour chart (similar)	RAL 2000
Moisture Level (MSL)		UL 94 flammability rating	V-0
Contact material	Copper alloy	Contact surface	tinned
Layer structure of plug contact	4...8 μm Sn hot-dip tinned	Storage temperature, min.	-40 °C
Storage temperature, max.	70 °C	Operating temperature, min.	-50 °C
Operating temperature, max.	100 °C	Temperature range, installation, min.	-25 °C
Temperature range, installation, max.	100 °C		

Conductors suitable for connection

Clamping range, min.	0.13 mm ²
Clamping range, max.	3.31 mm ²
Wire connection cross section AWG, min.	AWG 26
Wire connection cross section AWG, max.	AWG 12
Solid, min. H05(07) V-U	0.2 mm ²

SLF 5.08/08/180B SN OR BX

Weidmüller Interface GmbH & Co. KG
 Klingenbergstraße 26
 D-32758 Detmold
 Germany

www.weidmueller.com

Technical data

Solid, max. H05(07) V-U	2.5 mm ²
Flexible, min. H05(07) V-K	0.2 mm ²
Flexible, max. H05(07) V-K	2.5 mm ²
w. plastic collar ferrule, DIN 46228 pt 4, 0.2 mm ² min.	
w. plastic collar ferrule, DIN 46228 pt 4, 2.5 mm ² max.	
w. wire end ferrule, DIN 46228 pt 1, min.	0.2 mm ²
w. wire end ferrule, DIN 46228 pt 1, max.	2.5 mm ²
Plug gauge in accordance with EN 60999 a x b; ø	2.8 mm x 2.0 mm

Clampable conductor	Cross-section for conductor connection	Type	fine-wired
		nominal	0.5 mm ²
wire end ferrule	Stripping length	nominal	12 mm
		Recommended wire-end ferrule	H0,5/16 OR
		nominal	10 mm
		Recommended wire-end ferrule	H0,5/10
Cross-section for conductor connection	Type	fine-wired	
	nominal	0.75 mm ²	
wire end ferrule	Stripping length	nominal	12 mm
		Recommended wire-end ferrule	H0,75/16 W
		nominal	10 mm
		Recommended wire-end ferrule	H0,75/10
Cross-section for conductor connection	Type	fine-wired	
	nominal	1 mm ²	
wire end ferrule	Stripping length	nominal	12 mm
		Recommended wire-end ferrule	H1,0/16D R
		nominal	10 mm
		Recommended wire-end ferrule	H1,0/10
Cross-section for conductor connection	Type	fine-wired	
	nominal	1.5 mm ²	
wire end ferrule	Stripping length	nominal	10 mm
		Recommended wire-end ferrule	H1,5/10
		nominal	12 mm
		Recommended wire-end ferrule	H1,5/16 R
Cross-section for conductor connection	Type	fine-wired	
	nominal	2.5 mm ²	
wire end ferrule	Stripping length	nominal	10 mm
		Recommended wire-end ferrule	H2,5/14DS BL

Reference text The outside diameter of the plastic collar should not be larger than the pitch (P). Length of ferrules is to be chosen depending on the product and the rated voltage.

Rated data acc. to IEC

tested acc. to standard	IEC 60664-1, IEC 61984	Rated current, min. number of poles (Tu=20°C)	25.9 A
Rated current, max. number of poles (Tu=20°C)	21.7 A	Rated current, min. number of poles (Tu=40°C)	22.5 A

SLF 5.08/08/180B SN OR BX

Weidmüller Interface GmbH & Co. KG
 Klingenbergstraße 26
 D-32758 Detmold
 Germany

www.weidmueller.com

Technical data

Rated current, max. number of poles (Tu=40°C)	18.5 A	Rated voltage for surge voltage class / pollution degree II/2	400 V
Rated voltage for surge voltage class / pollution degree III/2	320 V	Rated voltage for surge voltage class / pollution degree III/3	250 V
Rated impulse voltage for surge voltage class/ pollution degree II/2	4000 V	Rated impulse voltage for surge voltage class/ pollution degree III/2	4 kV
Rated impulse voltage for surge voltage class/ contamination degree III/3	4 kV	Short-time withstand current resistance	3 x 1s with 120 A

Rated data acc. to CSA

Institute (CSA)	CSA	Certificate No. (CSA)	200039-1121690
Rated voltage (Use group B / CSA)	300 V	Rated voltage (Use group D / CSA)	300 V
Rated current (Use group B / CSA)	10 A	Rated current (Use group D / CSA)	10 A
Wire cross-section, AWG, min.	AWG 26	Wire cross-section, AWG, max.	AWG 12
Reference to approval values	Specifications are maximum values, details - see approval certificate.		

Rated data acc. to UL 1059

Institute (cURus)	CURUS	Certificate No. (cURus)	E60693
Rated voltage (Use group B / UL 1059)	300 V	Rated voltage (Use group D / UL 1059)	300 V
Rated current (Use group B / UL 1059)	14 A	Rated current (Use group D / UL 1059)	10 A
Wire cross-section, AWG, min.	AWG 26	Wire cross-section, AWG, max.	AWG 12
Reference to approval values	Specifications are maximum values, details - see approval certificate.		

Packing

Packaging	Box	VPE length	351.00 mm
VPE width	137.00 mm	VPE height	38.00 mm

Type tests

Test: Durability of markings	Standard	IEC 61984 section 6.2 and 7.3.2 / 10.11, IEC 60068-2-70 / 12.95	
	Test	mark of origin, type identification, pitch, date clock, type of material	
	Evaluation	available	
	Test	durability	
Test: Misengagement (Non-interchangeability)	Evaluation	passed	
	Standard	IEC 61984 section 6.3 and 6.9.1 / 10.11, IEC 60512-13-5 / 02.06	
	Test	180° turned with coding elements	
	Evaluation	passed	
Test: Clampable cross section	Test	visual examination	
	Evaluation	passed	
	Standard	IEC 60999-1 section 7 and 9.1 / 11.99, IEC 60947-1 section 8.2.4.5.1 / 03.11	
	Conductor type	Type of conductor and conductor cross-section	solid 0.5 mm ²
Type of conductor and conductor cross-section		stranded 0.5 mm ²	
Type of conductor and conductor cross-section		stranded 1.0 mm ²	

Technical data

		Type of conductor and conductor cross-section	solid 2.5 mm ²
		Type of conductor and conductor cross-section	AWG 26/1
		Type of conductor and conductor cross-section	AWG 26/19
		Type of conductor and conductor cross-section	AWG 14/1
		Type of conductor and conductor cross-section	AWG 14/19
	Evaluation	passed	
Test for damage to and accidental loosening of conductors	Standard	IEC 60999-1 section 9.4 / 11.99	
	Requirement	0.2 kg	
	Conductor type	Type of conductor and conductor cross-section	AWG 26/1
		Type of conductor and conductor cross-section	AWG 26/19
	Evaluation	passed	
	Requirement	0.3 kg	
	Conductor type	Type of conductor and conductor cross-section	H05V-U0.5
		Type of conductor and conductor cross-section	H05V-K0.5
	Evaluation	passed	
	Requirement	0.7 kg	
Pull-out test	Conductor type	Type of conductor and conductor cross-section	H07V-K2.5
		Type of conductor and conductor cross-section	H07V-U2.5
		Type of conductor and conductor cross-section	AWG 14/1
		Type of conductor and conductor cross-section	AWG 14/19
	Evaluation	passed	
	Standard	IEC 60999-1 section 9.5 / 11.99	
Requirement	≥10 N		
Conductor type	Type of conductor and conductor cross-section	AWG 26/1	
	Type of conductor and conductor cross-section	AWG 26/19	
Evaluation	passed		
Requirement	≥20 N		
Conductor type	Type of conductor and conductor cross-section	H05V-U0.5	
	Type of conductor and conductor cross-section	H05V-K0.5	

Technical data

Evaluation	passed	
Requirement	≥50 N	
Conductor type	Type of conductor and conductor cross-section	H07V-K2.5
	Type of conductor and conductor cross-section	H07V-U2.5
	Type of conductor and conductor cross-section	AWG 14/1
	Type of conductor and conductor cross-section	AWG 14/19
Evaluation	passed	

Important note

IPC conformity Conformity: The products are developed, manufactured and delivered according international recognized standards and norms and comply with the assured properties in the data sheet resp. fulfill decorative properties in accordance with IPC-A-610 "Class 2". Further claims on the products can be evaluated on request.

- Notes**
- Additional variants on request
 - Gold-plated contact surfaces on request
 - Rated current related to rated cross-section & min. No. of poles.
 - Wire end ferrule without plastic collar to DIN 46228/1
 - Wire end ferrule with plastic collar to DIN 46228/4
 - P on drawing = pitch
 - Crimping shape "A" for wire end ferrules with PZ 6/5 crimping tool recommended.
 - The test point can only be used as potential-pickup point.
 - In accordance with IEC 61984, OMNIMATE-connectors are connectors without breaking capacity (COC). During designated use, connectors are not allowed to be engaged or disengaged when live or under load
 - Long term storage of the product with average temperature of 50 °C and maximum humidity 70%, 36 months

Classifications

ETIM 8.0	EC002638	ETIM 9.0	EC002638
ETIM 10.0	EC002638	ECLASS 14.0	27-46-02-02
ECLASS 15.0	27-46-02-02		

SLF 5.08/08/180B SN OR BX

Weidmüller Interface GmbH & Co. KG
 Klingenbergstraße 26
 D-32758 Detmold
 Germany

www.weidmueller.com

Drawings

Product image

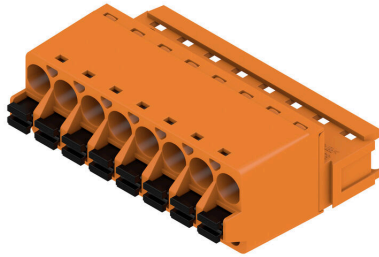

Dimensional drawing

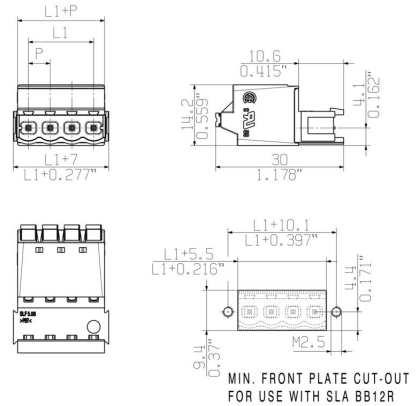

Graph

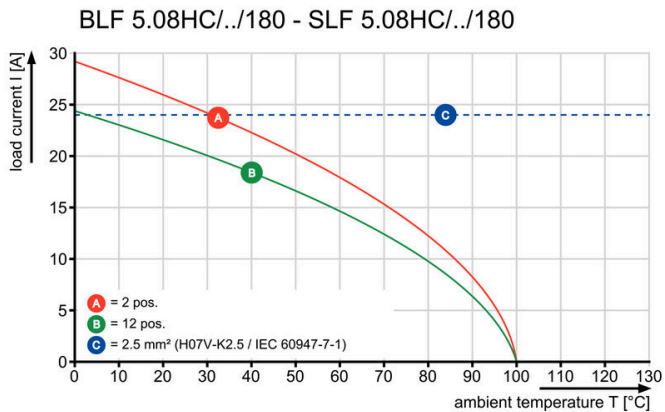

Graph

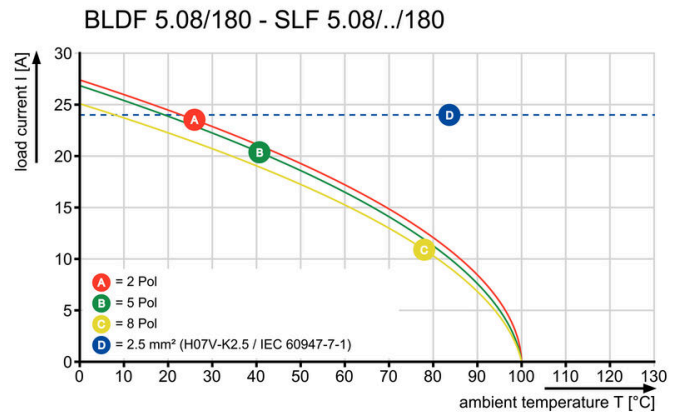

Product benefits



Uncompromising functionality High vibration resistance

Product benefits

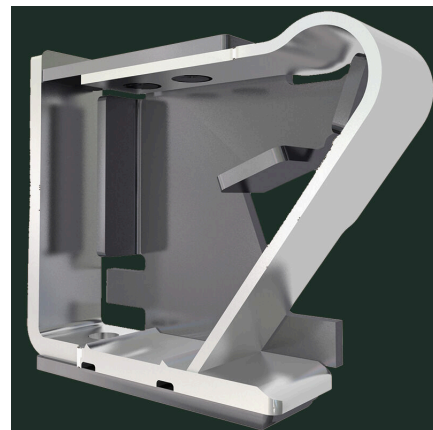

Solid PUSH IN contact Safe and durable

Drawings

Product benefits



Lower assembly costs
Secure in a matter of seconds

Product benefits

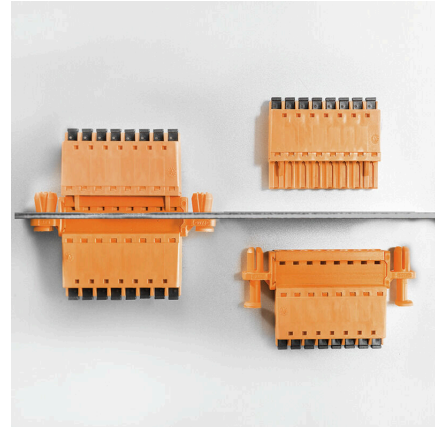

Easy handling
No implementation framework necessary

SLF 5.08/08/180B SN OR BX

Weidmüller Interface GmbH & Co. KG
 Klingenbergstraße 26
 D-32758 Detmold
 Germany

www.weidmueller.com

Accessories

Strain reliefs



For frequent load changes: the "trailer coupling" for plug-in connectors.

The strain relief can do more than just relieve the strain on conductors:

Simply clip onto the plug and

- bundle conductors
- guide cables
- use as a connection and disconnection aid

No damage to the connecting points, clear, tidy wiring and easy to handle.

User advantages: permanent heavy-duty connections for harsh industrial environments and convenient operation ensure improved system availability.

General ordering data

Type	BLF/SLF 5.08 ZE06 BK	Version
Order No.	2525850000	PCB plug-in connector, Accessories, Strain relief, black, Number of
GTIN (EAN)	4050118537116	poles: 6
Qty.	50 ST	
Type	BLF/SLF 5.08 ZE06 OR	Version
Order No.	2525780000	PCB plug-in connector, Accessories, Strain relief, orange, Number of
GTIN (EAN)	4050118536881	poles: 6
Qty.	50 ST	