

LMFS 5.08/10/180 3.5SN OR BX

Weidmüller Interface GmbH & Co. KG
 Klingenbergstraße 26
 D-32758 Detmold
 Germany

www.weidmueller.com

Product image

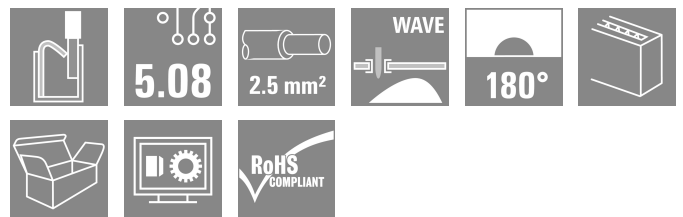
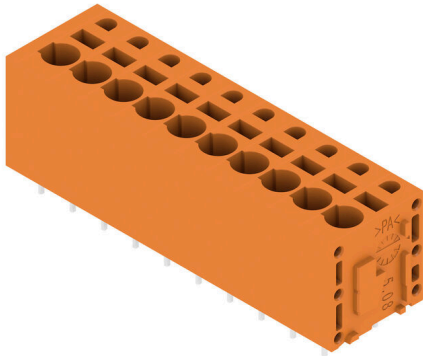

The new LMF allows us to meet the current market requirements for a PCB terminal with PUSH IN connection system for wire cross-sections up to 2.5 mm²

- PUSH IN connection system
- LMF with pusher for opening the terminal point
- LMFS without pusher, the terminal point is opened with a screwdriver
- Integrated test point
- 90° and 180° wire outlet direction

General ordering data

Version	Printed circuit board terminals, 5.08 mm, Number of poles: 10, 180°, Solder pin length (l): 3.5 mm, tinned, orange, PUSH IN, Clamping range, max. : 2.5 mm ² , Box
Order No.	1331520000
Type	LMFS 5.08/10/180 3.5SN OR BX
GTIN (EAN)	4050118135268
Qty.	25 items
Product data	IEC: 400 V / 24 A / 0.2 - 2.5 mm ² UL: 300 V / 20 A / AWG 24 - AWG 12
Packaging	Box

LMFS 5.08/10/180 3.5SN OR BX

Weidmüller Interface GmbH & Co. KG
Klingenbergstraße 26
D-32758 Detmold
Germany

www.weidmueller.com

Technical data

Approvals

Approvals



ROHS Conform

UL File Number Search [UL Website](#)

Certificate No. (cURus) E60693

Dimensions and weights

Depth	14.8 mm	Depth (inches)	0.5827 inch
Height	18.7 mm	Height (inches)	0.7362 inch
Height of lowest version	15.2 mm	Width	53.42 mm
Width (inches)	2.1031 inch	Net weight	14.47 g

Environmental Product Compliance

RoHS Compliance Status	Compliant without exemption
REACH SVHC	No SVHC above 0.1 wt%

System parameters

Product family	OMNIMATE Signal - series LMF	Wire connection method	PUSH IN
Mounting onto the PCB	THT solder connection	Conductor outlet direction	180°
Pitch in mm (P)	5.08 mm	Pitch in inches (P)	0.200 "
Number of poles	10	Pin series quantity	1
Fitted by customer	No	Number of rows	1
Max. adjacent poles per row	24	Solder pin length (l)	3.5 mm
Solder pin dimensions	d = 0.8 mm, 0.6 x 0.8 mm	Solder eyelet hole diameter (D)	1.1 mm
Solder eyelet hole diameter tolerance (D)+	0,1 mm	Number of solder pins per pole	2
Screwdriver blade	0.6 x 3.5	Screwdriver blade standard	DIN 5264
Stripping length	10 mm	L1 in mm	45.72 mm
L1 in inches	1.800 "	Touch-safe protection acc. to DIN VDE 0470	IP 20
Touch-safe protection acc. to DIN VDE 57 106	Safe from finger touch	Protection degree	IP20

Material data

Insulating material	Wemid (PA)	Colour	orange
Colour chart (similar)	RAL 2000	Comparative Tracking Index (CTI)	≥ 600
Moisture Level (MSL)		UL 94 flammability rating	V-0
Contact material	Cu-alloy	Contact surface	tinned
Coating	4-6 µm SN	Tinning type	matt
Layer structure of solder connection	4...8 µm Sn matt	Storage temperature, min.	-40 °C
Storage temperature, max.	70 °C	Operating temperature, min.	-50 °C
Operating temperature, max.	120 °C	Temperature range, installation, min.	-25 °C
Temperature range, installation, max.	120 °C		

Conductors suitable for connection

Clamping range, min.	0.12 mm ²
Clamping range, max.	2.5 mm ²
Wire connection cross section AWG, min.	AWG 24

LMFS 5.08/10/180 3.5SN OR BX

Weidmüller Interface GmbH & Co. KG
 Klingenbergstraße 26
 D-32758 Detmold
 Germany

www.weidmueller.com

Technical data

Wire connection cross section AWG, max.	AWG 12			
Solid, min. H05(07) V-U	0.2 mm ²			
Solid, max. H05(07) V-U	2.5 mm ²			
Flexible, min. H05(07) V-K	0.2 mm ²			
Flexible, max. H05(07) V-K	2.5 mm ²			
w. plastic collar ferrule, DIN 46228 pt 4, min.	0.25 mm ²			
w. plastic collar ferrule, DIN 46228 pt 4, max.	2.5 mm ²			
w. wire end ferrule, DIN 46228 pt 1, min.	0.25 mm ²			
w. wire end ferrule, DIN 46228 pt 1, max.	2.5 mm ²			
Plug gauge in accordance with EN 60999 a x b; ø	2.4 mm x 1.5 mm			
Clampable conductor	Cross-section for conductor connection	Type	fine-wired	
		nominal	0.5 mm ²	
	wire end ferrule	Stripping length	nominal	12 mm
		Recommended wire-end ferrule	H0.5/16 OR	
		Stripping length	nominal	10 mm
		Recommended wire-end ferrule	H0.5/10	
	Cross-section for conductor connection	Type	fine-wired	
		nominal	0.75 mm ²	
	wire end ferrule	Stripping length	nominal	12 mm
		Recommended wire-end ferrule	H0.75/16 W	
		Stripping length	nominal	10 mm
		Recommended wire-end ferrule	H0.75/10	
	Cross-section for conductor connection	Type	fine-wired	
		nominal	1 mm ²	
	wire end ferrule	Stripping length	nominal	12 mm
		Recommended wire-end ferrule	H1.0/16D R	
		Stripping length	nominal	10 mm
		Recommended wire-end ferrule	H1.0/10	
	Cross-section for conductor connection	Type	fine-wired	
		nominal	1.5 mm ²	
	wire end ferrule	Stripping length	nominal	10 mm
		Recommended wire-end ferrule	H1.5/10	
		Stripping length	nominal	12 mm
		Recommended wire-end ferrule	H1.5/16 R	
Cross-section for conductor connection	Type	fine-wired		
	nominal	2.5 mm ²		
wire end ferrule	Stripping length	nominal	10 mm	
	Recommended wire-end ferrule	H2.5/10		

Reference text Length of ferrules is to be chosen depending on the product and the rated voltage. The outside diameter of the plastic collar should not be larger than the pitch (P)

LMFS 5.08/10/180 3.5SN OR BX

Weidmüller Interface GmbH & Co. KG
 Klingenbergstraße 26
 D-32758 Detmold
 Germany

www.weidmueller.com

Technical data

Rated data acc. to IEC

tested acc. to standard	IEC 60664-1, IEC 60947-7-4	Rated current, min. number of poles (Tu=20°C)	24 A
Rated current, max. number of poles (Tu=20°C)	24 A	Rated current, min. number of poles (Tu=40°C)	24 A
Rated current, max. number of poles (Tu=40°C)	24 A	Rated voltage for surge voltage class / pollution degree II/2	400 V
Rated voltage for surge voltage class / pollution degree III/2	320 V	Rated voltage for surge voltage class / pollution degree III/3	250 V
Rated impulse voltage for surge voltage class/ pollution degree II/2	4 kV	Rated impulse voltage for surge voltage class/ pollution degree III/2	4 kV
Rated impulse voltage for surge voltage class/ contamination degree III/3	4 kV	Short-time withstand current resistance	3 x 1s with 120 A

Rated data acc. to CSA

Rated voltage (Use group B / CSA)	300 V	Rated voltage (Use group D / CSA)	300 V
Rated current (Use group B / CSA)	20 A	Rated current (Use group D / CSA)	10 A
Wire cross-section, AWG, min.	AWG 24	Wire cross-section, AWG, max.	AWG 12

Rated data acc. to UL 1059

Institute (cURus)	CURUS	Certificate No. (cURus)	E60693
Rated voltage (Use group B / UL 1059)	300 V	Rated voltage (Use group D / UL 1059)	300 V
Rated current (Use group B / UL 1059)	20 A	Rated current (Use group D / UL 1059)	10 A
Wire cross-section, AWG, min.	AWG 24	Wire cross-section, AWG, max.	AWG 12
Reference to approval values	Specifications are maximum values, details - see approval certificate.		

Packing

Packaging	Box	VPE length	350.00 mm
VPE width	138.00 mm	VPE height	32.00 mm

Type tests

Test: Durability of markings	Standard	IEC 61984 section 6.2 and 7.3.2 / 10.11	
	Test	mark of origin, type identification, type of material, approval marking UL, approval marking CSA, durability, pitch, date clock	
	Evaluation	available	
Test: Clampable cross section	Standard	IEC 60999-1 section 7 and 9.1 / 11.99, IEC 60947-1 section 8.2.4.5.1 / 03.11	
	Conductor type	Type of conductor and conductor cross-section	solid 0.14 mm ²
		Type of conductor and conductor cross-section	stranded 0.14 mm ²
		Type of conductor and conductor cross-section	solid 2.5 mm ²
		Type of conductor and conductor cross-section	stranded 2.5 mm ²
		Type of conductor and conductor cross-section	AWG 26/1

LMFS 5.08/10/180 3.5SN OR BX

Weidmüller Interface GmbH & Co. KG
 Klingenbergstraße 26
 D-32758 Detmold
 Germany

www.weidmueller.com

Technical data

Test for damage to and accidental loosening of conductors		Type of conductor and conductor cross-section	AWG26/19	
		Type of conductor and conductor cross-section	AWG 14/1	
		Type of conductor and conductor cross-section	AWG 12/19	
	Evaluation	passed		
	Standard	IEC 60999-1 section 9.4 / 11.99		
	Requirement	0.3 kg		
	Conductor type	Type of conductor and conductor cross-section	H05V-U0.5	
		Type of conductor and conductor cross-section	H05V-K0.5	
	Evaluation	passed		
	Requirement	0.7 kg		
Pull-out test	Conductor type	Type of conductor and conductor cross-section	H07V-U2.5	
		Type of conductor and conductor cross-section	H07V-K2.5	
	Evaluation	passed		
	Standard	IEC 60999-1 section 9.5 / 11.99		
	Requirement	≥20 N		
	Conductor type	Type of conductor and conductor cross-section	H05V-U0.5	
		Type of conductor and conductor cross-section	H05V-K0.5	
	Evaluation	passed		
	Requirement	≥50 N		
	Conductor type	Type of conductor and conductor cross-section	H07V-U2.5	
Type of conductor and conductor cross-section		H07V-K2.5		
Evaluation	passed			

Important note

IPC conformity Conformity: The products are developed, manufactured and delivered according international recognized standards and norms and comply with the assured properties in the data sheet resp. fulfill decorative properties in accordance with IPC-A-610 "Class 2". Further claims on the products can be evaluated on request.

- Notes
- Additional variants on request
 - Rated current related to rated cross-section & min. No. of poles.
 - Wire end ferrule without plastic collar to DIN 46228/1
 - Wire end ferrule with plastic collar to DIN 46228/4
 - P on drawing = pitch
 - Rated data refer only to the component itself. Clearance and creepage distances to other components are to be designed in accordance with the relevant application standards.
 - The test point can only be used as potential-pickup point.
 - Long term storage of the product with average temperature of 50 °C and maximum humidity 70%, 36 months

Technical data

Classifications

ETIM 8.0	EC002643	ETIM 9.0	EC002643
ETIM 10.0	EC002643	ECLASS 14.0	27-46-01-01
ECLASS 15.0	27-46-01-01		

LMFS 5.08/10/180 3.5SN OR BX

Weidmüller Interface GmbH & Co. KG
 Klingenbergstraße 26
 D-32758 Detmold
 Germany

www.weidmueller.com

Drawings

Product image

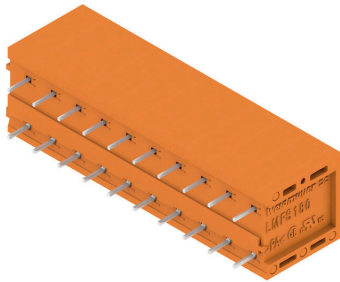

Dimensional drawing

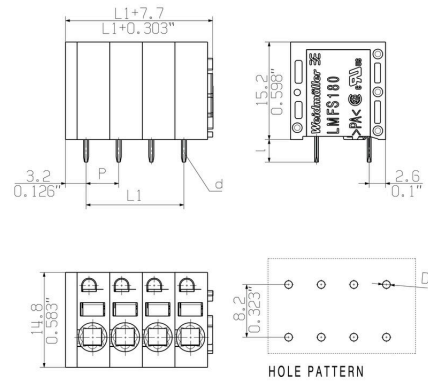

Graph

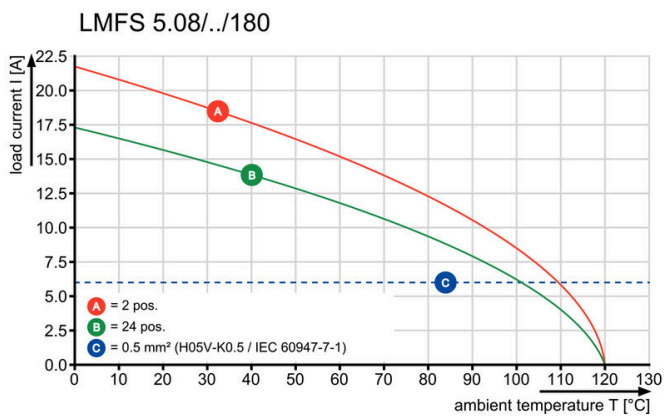

Graph

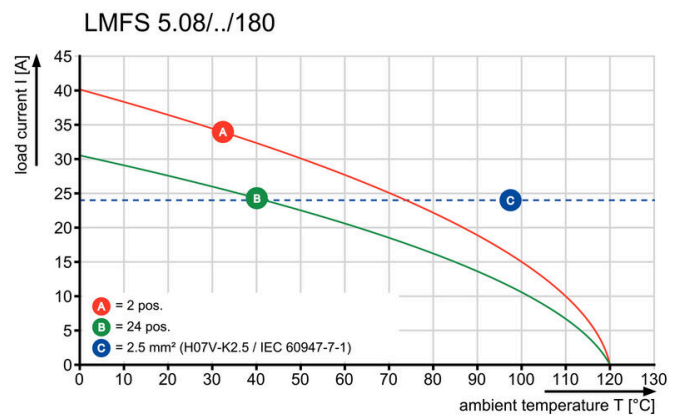

Drawings

Product benefits

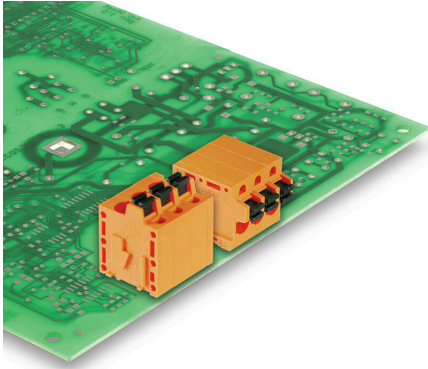

Optional conductor outlet
directionStable mechanical design

Product benefits

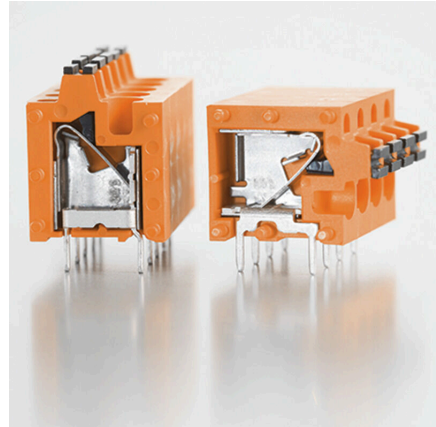

High reliability of the current capacity

Product benefits

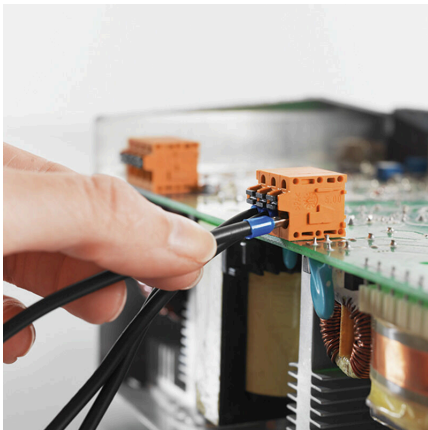

Direct conductor entryCross section up to 2.5 mm²

Product benefits

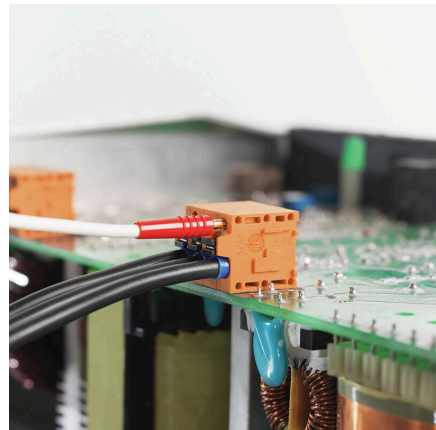

Maintenance through test point

LMFS 5.08/10/180 3.5SN OR BX

Weidmüller Interface GmbH & Co. KG
 Klingenbergstraße 26
 D-32758 Detmold
 Germany

www.weidmueller.com

Accessories

Slotted screwdriver



VDE insulated slot-head screwdriver, SDI DIN 7437, ISO 2380/2, drive output acc. to DIN 5264, ISO 2380/1.
 SoftFinish grip

General ordering data

Type	SDIS 0.6X3.5X100	Version	
Order No.	9008390000	Screwdriver, Screwdriver	
GTIN (EAN)	4032248056354		
Qty.	1 ST		

Additional accessories



No task is too small when creating the perfect solution. Connections form just one part of the overall process. Small details are often the key to the perfect solution in applications where potentials are tested, grouped or even isolated.

A system is not a system without small but essential details:

- Test plugs ensure reliable pick-up from diagnostic sockets

In tandem with the manufacturing process and application.

General ordering data

Type	PS 2.0 MC	Version	
Order No.	0310000000	PCB plug-in connector, Accessories, Test plug, red, Number of poles:	
GTIN (EAN)	4008190000059		
Qty.	20 ST		1