

LMF 5.00/13/180 3.5SN OR BX

Weidmüller Interface GmbH & Co. KG

Klingenbergstraße 26

D-32758 Detmold

Germany

www.weidmueller.com

Product image

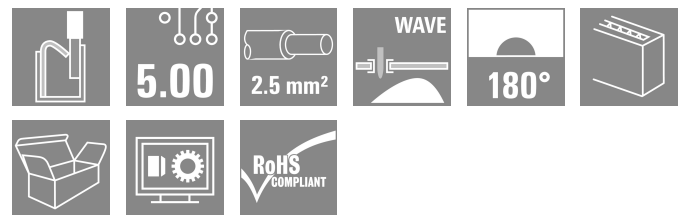
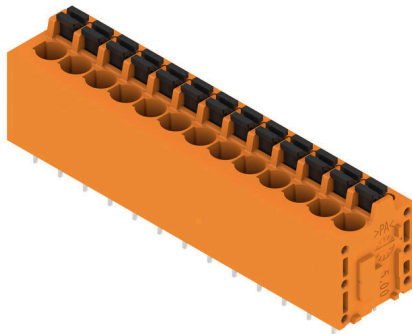

The new LMF allows us to meet the current market requirements for a PCB terminal with PUSH IN connection system for wire cross-sections up to 2.5 mm²

- PUSH IN connection system
- LMF with pusher for opening the terminal point
- LMFS without pusher, the terminal point is opened with a screwdriver
- Integrated test point
- 90° and 180° wire outlet direction

General ordering data

| | |
|--------------|---|
| Version | Printed circuit board terminals, 5.00 mm, Number of poles: 13, 180°, Solder pin length (l): 3.5 mm, tinned, orange, PUSH IN with actuator, Clamping range, max. : 2.5 mm ² , Box |
| Order No. | 1330300000 |
| Type | LMF 5.00/13/180 3.5SN OR BX |
| GTIN (EAN) | 4050118134186 |
| Qty. | 20 items |
| Product data | IEC: 400 V / 24 A / 0.5 - 2.5 mm ² UL: 300 V / 20 A / AWG 24 - AWG 12 |
| Packaging | Box |

LMF 5.00/13/180 3.5SN OR BX

Weidmüller Interface GmbH & Co. KG
Klingenbergstraße 26
D-32758 Detmold
Germany

www.weidmueller.com

Technical data

Approvals

Approvals



| | |
|-------------------------|----------------------------|
| ROHS | Conform |
| UL File Number Search | UL Website |
| Certificate No. (cURus) | E60693 |

Dimensions and weights

| | | | |
|--------------------------|-------------|-----------------|-------------|
| Depth | 14.8 mm | Depth (inches) | 0.5827 inch |
| Height | 22.7 mm | Height (inches) | 0.8937 inch |
| Height of lowest version | 19.2 mm | Width | 67.7 mm |
| Width (inches) | 2.6653 inch | Net weight | 19.36 g |

Environmental Product Compliance

| | |
|------------------------|-----------------------------|
| RoHS Compliance Status | Compliant without exemption |
| REACH SVHC | No SVHC above 0.1 wt% |

System parameters

| | | | |
|--|------------------------------|--|-----------------------|
| Product family | OMNIMATE Signal - series LMF | Wire connection method | PUSH IN with actuator |
| Mounting onto the PCB | THT solder connection | Conductor outlet direction | 180° |
| Pitch in mm (P) | 5.00 mm | Pitch in inches (P) | 0.197 " |
| Number of poles | 13 | Pin series quantity | 1 |
| Fitted by customer | No | Number of rows | 1 |
| Max. adjacent poles per row | 24 | Solder pin length (l) | 3.5 mm |
| Solder pin dimensions | d = 0.8 mm | Solder eyelet hole diameter (D) | 1.1 mm |
| Solder eyelet hole diameter tolerance (D) | + 0,1 mm | Number of solder pins per pole | 2 |
| Screwdriver blade | 0.6 x 3.5 | Screwdriver blade standard | DIN 5264 |
| Stripping length | 10 mm | L1 in mm | 60.00 mm |
| L1 in inches | 2.362 " | Touch-safe protection acc. to DIN VDE 0470 | IP 20 |
| Touch-safe protection acc. to DIN VDE 57 106 | Safe from finger touch | Protection degree | IP20 |

Material data

| | | | |
|---------------------------------------|------------------|---------------------------------------|--------|
| Insulating material | Wemid (PA) | Colour | orange |
| Colour chart (similar) | RAL 2000 | Comparative Tracking Index (CTI) | ≥ 600 |
| Moisture Level (MSL) | | UL 94 flammability rating | V-0 |
| Contact material | Cu-alloy | Contact surface | tinned |
| Coating | 4-6 µm SN | Tinning type | matt |
| Layer structure of solder connection | 4...6 µm Sn matt | Storage temperature, min. | -40 °C |
| Storage temperature, max. | 70 °C | Operating temperature, min. | -50 °C |
| Operating temperature, max. | 120 °C | Temperature range, installation, min. | -25 °C |
| Temperature range, installation, max. | 120 °C | | |

Conductors suitable for connection

| | |
|----------------------|----------------------|
| Clamping range, min. | 0.12 mm ² |
| Clamping range, max. | 2.5 mm ² |

LMF 5.00/13/180 3.5SN OR BX

Weidmüller Interface GmbH & Co. KG
 Klingenbergstraße 26
 D-32758 Detmold
 Germany

www.weidmueller.com

Technical data

| | |
|---|----------------------|
| Wire connection cross section AWG, min. | AWG 24 |
| Wire connection cross section AWG, max. | AWG 12 |
| Solid, min. H05(07) V-U | 0.5 mm ² |
| Solid, max. H05(07) V-U | 2.5 mm ² |
| Flexible, min. H05(07) V-K | 0.25 mm ² |
| Flexible, max. H05(07) V-K | 2.5 mm ² |
| w. plastic collar ferrule, DIN 46228 pt 4, min. | 0.25 mm ² |
| w. plastic collar ferrule, DIN 46228 pt 4, max. | 2.5 mm ² |
| w. wire end ferrule, DIN 46228 pt 1, min. | 0.25 mm ² |
| w. wire end ferrule, DIN 46228 pt 1, max. | 2.5 mm ² |
| Plug gauge in accordance with EN 60999 a x b; ø | 2.4 mm x 1.5 mm |

| Clampable conductor | Cross-section for conductor connection | Type | fine-wired | |
|--|--|------------------------------|-----------------------------|-------|
| | | nominal | 0.5 mm ² | |
| wire end ferrule | | Stripping length | nominal | 12 mm |
| | | Recommended wire-end ferrule | H0.5/16 OR | |
| | | Stripping length | nominal | 10 mm |
| | | Recommended wire-end ferrule | H0.5/10 | |
| Cross-section for conductor connection | | Type | fine-wired | |
| | | nominal | 0.75 mm ² | |
| | | Stripping length | nominal | 12 mm |
| | | Recommended wire-end ferrule | H0.75/16 W | |
| wire end ferrule | | Stripping length | nominal | 10 mm |
| | | Recommended wire-end ferrule | H0.75/10 | |
| | | Stripping length | nominal | 12 mm |
| | | Recommended wire-end ferrule | H1.0/16 D R | |
| Cross-section for conductor connection | | Type | fine-wired | |
| | | nominal | 1 mm ² | |
| | | Stripping length | nominal | 12 mm |
| | | Recommended wire-end ferrule | H1.0/16 D R | |
| wire end ferrule | | Stripping length | nominal | 10 mm |
| | | Recommended wire-end ferrule | H1.0/10 | |
| | | Stripping length | nominal | 12 mm |
| | | Recommended wire-end ferrule | H1.5/16 R | |
| Cross-section for conductor connection | | Type | fine-wired | |
| | | nominal | 1.5 mm ² | |
| | | Stripping length | nominal | 10 mm |
| | | Recommended wire-end ferrule | H1.5/10 | |
| wire end ferrule | | Stripping length | nominal | 12 mm |
| | | Recommended wire-end ferrule | H1.5/16 R | |
| | | Stripping length | nominal | 10 mm |
| | | Recommended wire-end ferrule | H2.5/10 | |

Reference text Length of ferrules is to be chosen depending on the product and the rated voltage., The outside diameter of the plastic collar should not be larger than the pitch (P)

LMF 5.00/13/180 3.5SN OR BX

Weidmüller Interface GmbH & Co. KG
 Klingenbergstraße 26
 D-32758 Detmold
 Germany

www.weidmueller.com

Technical data

Rated data acc. to IEC

| | | | |
|---|------------------------|---|-------------------|
| tested acc. to standard | IEC 60664-1, IEC 61984 | Rated current, min. number of poles (Tu=20°C) | 24 A |
| Rated current, max. number of poles (Tu=20°C) | 24 A | Rated current, min. number of poles (Tu=40°C) | 24 A |
| Rated current, max. number of poles (Tu=40°C) | 24 A | Rated voltage for surge voltage class / pollution degree II/2 | 400 V |
| Rated voltage for surge voltage class / pollution degree III/2 | 320 V | Rated voltage for surge voltage class / pollution degree III/3 | 250 V |
| Rated impulse voltage for surge voltage class/ pollution degree II/2 | 4 kV | Rated impulse voltage for surge voltage class/ pollution degree III/2 | 4 kV |
| Rated impulse voltage for surge voltage class/ contamination degree III/3 | 4 kV | Short-time withstand current resistance | 3 x 1s with 120 A |

Rated data acc. to CSA

| | | | |
|-----------------------------------|--|-----------------------------------|----------------|
| Institute (CSA) | CSA | Certificate No. (CSA) | 200039-1815154 |
| Rated voltage (Use group B / CSA) | 300 V | Rated voltage (Use group D / CSA) | 300 V |
| Rated current (Use group B / CSA) | 20 A | Rated current (Use group D / CSA) | 10 A |
| Wire cross-section, AWG, min. | AWG 24 | Wire cross-section, AWG, max. | AWG 12 |
| Reference to approval values | Specifications are maximum values, details - see approval certificate. | | |

Rated data acc. to UL 1059

| | | | |
|---------------------------------------|--|---------------------------------------|--------|
| Institute (cURus) | CURUS | Certificate No. (cURus) | E60693 |
| Rated voltage (Use group B / UL 1059) | 300 V | Rated voltage (Use group D / UL 1059) | 300 V |
| Rated current (Use group B / UL 1059) | 20 A | Rated current (Use group D / UL 1059) | 10 A |
| Wire cross-section, AWG, min. | AWG 24 | Wire cross-section, AWG, max. | AWG 12 |
| Reference to approval values | Specifications are maximum values, details - see approval certificate. | | |

Packing

| | | | |
|-----------|-----------|------------|-----------|
| Packaging | Box | VPE length | 338.00 mm |
| VPE width | 130.00 mm | VPE height | 27.00 mm |

Type tests

| | | | |
|-------------------------------|----------------|--|-------------------------------|
| Test: Durability of markings | Standard | DIN EN 60512-1-1 / 01.03 | |
| | Test | mark of origin, type identification, pitch, approval marking UL, durability | |
| | Evaluation | available | |
| Test: Clampable cross section | Standard | DIN EN 60999-1 section 7 and 9.1 / 12.00, DIN EN 60947-1 section 8.2.4.5.1 / 12.02 | |
| | Conductor type | Type of conductor and conductor cross-section | solid 0.14 mm ² |
| | | Type of conductor and conductor cross-section | stranded 0.14 mm ² |
| | | Type of conductor and conductor cross-section | solid 1.5 mm ² |
| | | Type of conductor and conductor cross-section | stranded 1.5 mm ² |

LMF 5.00/13/180 3.5SN OR BX

Weidmüller Interface GmbH & Co. KG
 Klingenbergstraße 26
 D-32758 Detmold
 Germany

www.weidmueller.com

Technical data

| | | |
|----------------|---|-----------|
| Conductor type | Type of conductor and conductor cross-section | H07V-U1.5 |
| | Type of conductor and conductor cross-section | H07V-K1.5 |
| | Type of conductor and conductor cross-section | AWG 16/1 |
| | Type of conductor and conductor cross-section | AWG 16/19 |
| Evaluation | passed | |

Important note

| | |
|----------------|---|
| IPC conformity | Conformity: The products are developed, manufactured and delivered according international recognized standards and norms and comply with the assured properties in the data sheet resp. fulfill decorative properties in accordance with IPC-A-610 "Class 2". Further claims on the products can be evaluated on request. |
| Notes | <ul style="list-style-type: none"> • Additional variants on request • Rated current related to rated cross-section & min. No. of poles. • Wire end ferrule without plastic collar to DIN 46228/1 • Wire end ferrule with plastic collar to DIN 46228/4 • P on drawing = pitch • Rated data refer only to the component itself. Clearance and creepage distances to other components are to be designed in accordance with the relevant application standards. • The test point can only be used as potential-pickup point. • Long term storage of the product with average temperature of 50 °C and maximum humidity 70%, 36 months |

Classifications

| | | | |
|-------------|-------------|-------------|-------------|
| ETIM 8.0 | EC002643 | ETIM 9.0 | EC002643 |
| ETIM 10.0 | EC002643 | ECLASS 14.0 | 27-46-01-01 |
| ECLASS 15.0 | 27-46-01-01 | | |

LMF 5.00/13/180 3.5SN OR BX

Weidmüller Interface GmbH & Co. KG
 Klingenbergstraße 26
 D-32758 Detmold
 Germany

www.weidmueller.com

Drawings

Product image

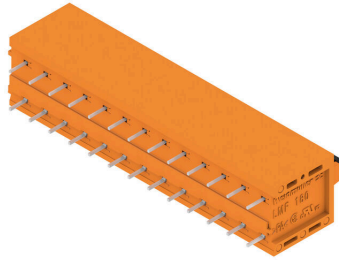

Dimensional drawing

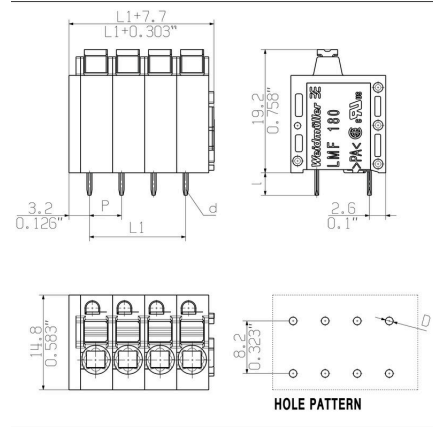

Graph

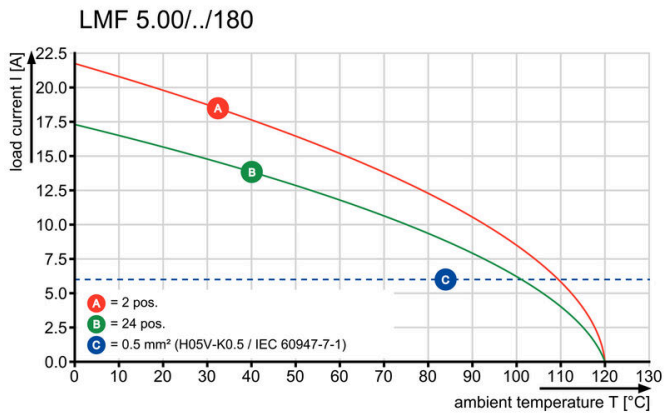

Graph

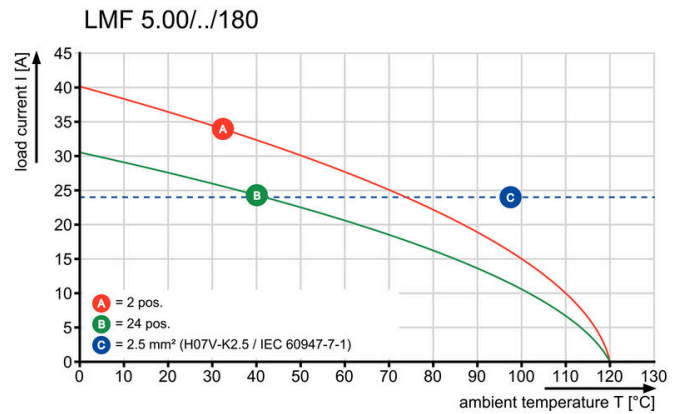

Drawings

Product benefits

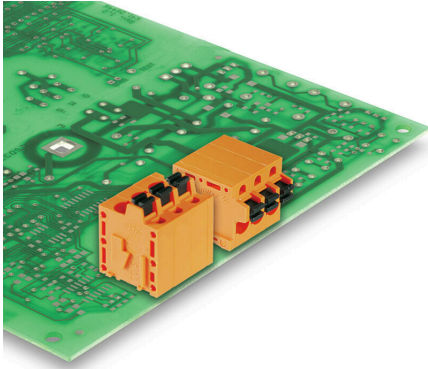

Optional conductor outlet
directionStable mechanical design

Product benefits

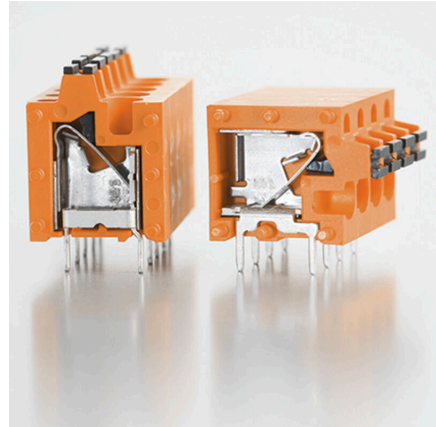

High reliability of the current capacity

Product benefits

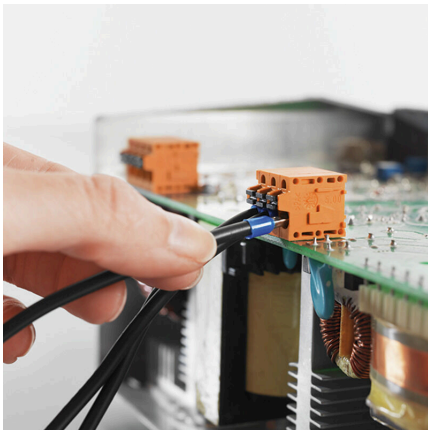

Direct conductor entryCross section up to 2.5 mm²

Product benefits

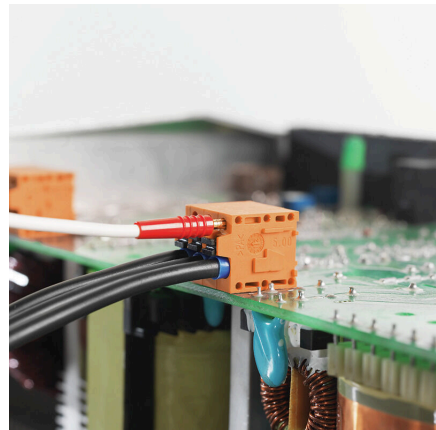

Maintenance through test point

LMF 5.00/13/180 3.5SN OR BX

Weidmüller Interface GmbH & Co. KG
 Klingenbergstraße 26
 D-32758 Detmold
 Germany

www.weidmueller.com

Accessories

Slotted screwdriver



VDE insulated slot-head screwdriver, SDI DIN 7437, ISO 2380/2, drive output acc. to DIN 5264, ISO 2380/1. SoftFinish grip

General ordering data

| | | | |
|------------|----------------------------|--------------------------|--|
| Type | SDIS 0.6X3.5X100 | Version | |
| Order No. | 9008390000 | Screwdriver, Screwdriver | |
| GTIN (EAN) | 4032248056354 | | |
| Qty. | 1 ST | | |

Additional accessories



No task is too small when creating the perfect solution. Connections form just one part of the overall process. Small details are often the key to the perfect solution in applications where potentials are tested, grouped or even isolated.

A system is not a system without small but essential details:

- Test plugs ensure reliable pick-up from diagnostic sockets

In tandem with the manufacturing process and application.

General ordering data

| | | | |
|------------|----------------------------|--|---|
| Type | PS 2.0 MC | Version | |
| Order No. | 0310000000 | PCB plug-in connector, Accessories, Test plug, red, Number of poles: | |
| GTIN (EAN) | 4008190000059 | | |
| Qty. | 20 ST | | 1 |