

ACT20X-HUI-SAO-LP-S

Weidmüller Interface GmbH & Co. KG

Klingenbergstraße 26

D-32758 Detmold

Germany

www.weidmueller.com

Product is no longer available, Data sheet for information only

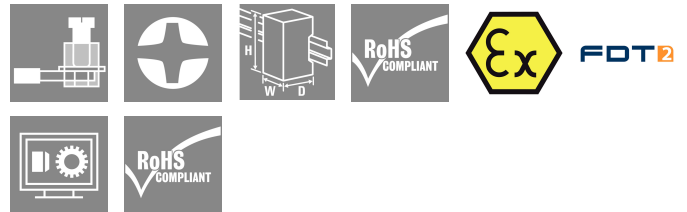

The ACT 20X HUI-SAO-S/ SAO-LP universal measurement and signal isolating converters can be configured individually.

Temperature signals from PT100 sensors and thermocouples as well as analogue DC current and voltage signals can be recorded from Ex zone 0.

On the output side, optional current/voltage (SAO-S) or 4...20 mA current loop signals (SAO-LP / SAO-S) are provided for the safe zone.

The ACT20X-HUI-SAO-S also has a relay output for configuring its switching threshold.

An integrated alarm contact is available on this device for issuing an alert in the event of a malfunction. This makes troubleshooting easier and also increases system availability.

The power supply of the signal isolating converter is either done using the integrated power supply (SAO-S) or alternatively over the output-side current loop (SAO-LP). The rail mountable devices are designed with one channel, and are optionally available in widths of 12.5 mm (SAO-LP) or 22.5 mm (SAO-S).

General ordering data

Version	ACT20X, EX signal isolating converter, 1-channel version, Output-loop powered
Order No.	1318220000
Type	ACT20X-HUI-SAO-LP-S
GTIN (EAN)	4050118323955
Qty.	1 items
Delivery status	Discontinued
Available until	2021-12-15T00:00:00+01:00

ACT20X-HUI-SAO-LP-S

Weidmüller Interface GmbH & Co. KG

 Klingenbergstraße 26
 D-32758 Detmold
 Germany

www.weidmueller.com

Technical data

Approvals

Approvals	CE; TUEVSATEX
Approvals	CULUS; EAC; IECEXKEM; ATEX
Approvals	

ROHS	Conform
------	---------

Dimensions and weights

Depth	113.6 mm	Depth (inches)	4.4724 inch
Height	117.2 mm	Height (inches)	4.6142 inch
Width	12.5 mm	Width (inches)	0.4921 inch
Net weight	125 g		

Temperatures

Storage temperature	-20 °C...70 °C	Operating temperature	0 °C...60 °C
Humidity at operating temperature	0...95 % (no condensation)	Humidity	10...90 %, no condensation

Probability of failure

SIL in compliance with IEC 61508	2
----------------------------------	---

Environmental Product Compliance

RoHS Compliance Status	Compliant with exemption
RoHS Exemption (if applicable/known)	7a, 7cl
REACH SVHC	Lead 7439-92-1
SCIP	2f6dd957-421a-46db-a0c2-cf1609156924

Assembling

Type of mounting	DIN rail	Mounting rail	TS 35
Mounting position	horizontal or vertical		

Input EX

Sensor	2-/3-/4-wire, RTD: PT10, PT20, PT50, PT100, PT250, PT300, PT400, PT500, PT1000, Ni50, Ni100, Ni120, Ni1000, Thermocouples: B, E, J, K, N, R, S, T; in compliance with IEC 60584-1 and L, U in compliance with DIN43710, Potentiometer, Resistance: 0 - 12 kΩ	Input resistance	0...12 kΩ
Type	intrinsically safe circuit	Line resistance in measuring circuit	≤ 50 Ω
Potentiometer	1.2...500 kΩ	Sensor supply	28...16.5 V DC / 0...20 mA
Input voltage	configurable, ± 12 V DC (min. measurement range 1 V), ± 28 V DC (min. measurement range 2	Temperature input range	Adjustable from -200...+800°C

ACT20X-HUI-SAO-LP-S

Weidmüller Interface GmbH & Co. KG

 Klingenbergstraße 26
 D-32758 Detmold
 Germany

www.weidmueller.com

Technical data

	V), ± 600 mV DC (min. measurement range 50 mV), ± 150 mV DC (min. measurement range 15 mV)		
Input current	configurable, ± 25 mA, 0...20 mA, 4...20mA	Input resistance, voltage	> 10 MΩ @ 600 mV, 2 MΩ @ 28 V
Input resistance, current	70 Ω		

Alarm output

Number of outputs	1
-------------------	---

General specifications

Type of connection	Screw connection	Accuracy	<0.1 % of end value
Humidity	10...90 %, no condensation	Protection degree	IP20
Supply voltage	via output current loop, 11...28 V DC (loop powered)	Step response time	250 ms (10...90%)
Power consumption	≤ 3.5 W	Temperature coefficient	<0.02 °C of measuring range / °C
Configuration	With FDT/DTM software, Requires configuration adapter 8978580000 CBX200 USB		

Insulation coordination

Impulse withstand voltage	4 kV (1.2/50 μs)	Standards	DIN EN 61326-1, IEC 61010-1, IEC 61010-2-030, IEC 60079-0, IEC 60079-11, IEC 60079-15, IEC 60079-26
Surge voltage category	III	Pollution severity	2
Insulation voltage	3.51 kV between input and output	Rated voltage	300 Veff

Data for Ex applications (ATEX)

Marking	II 3 G Ex nA IIC T4 Gc, I (M1) [Ex ia Ma] I, II (1) D [Ex ia Da] IIIC	Current I ₀	88.2 mA
Voltage U ₀	5.88 V DC	Power P ₀	129 mW
Installation location	Device installed in safe area, zone 2		

Connection data

Type of connection	Screw connection	Tightening torque, min.	0.4 Nm
Tightening torque, max.	0.6 Nm	Clamping range, rated connection	2.5 mm ²
Clamping range, min.	0.25 mm ²	Clamping range, max.	2.5 mm ²
Wire connection cross section AWG, min.	AWG 26	Wire connection cross section AWG, max.	AWG 12

Guarantee

Time interval	3 years
---------------	---------

ACT20X-HUI-SAO-LP-S

Weidmüller Interface GmbH & Co. KG
Klingenbergstraße 26
D-32758 Detmold
Germany

www.weidmueller.com

Technical data

Classifications

ETIM 8.0	EC002653	ETIM 9.0	EC002653
ETIM 10.0	EC002653	ECLASS 14.0	27-21-01-20
ECLASS 15.0	27-21-01-20		

ACT20X-HUI-SAO-LP-S

Weidmüller Interface GmbH & Co. KG
 Klingenbergstraße 26
 D-32758 Detmold
 Germany

www.weidmueller.com

Drawings

Connection diagram

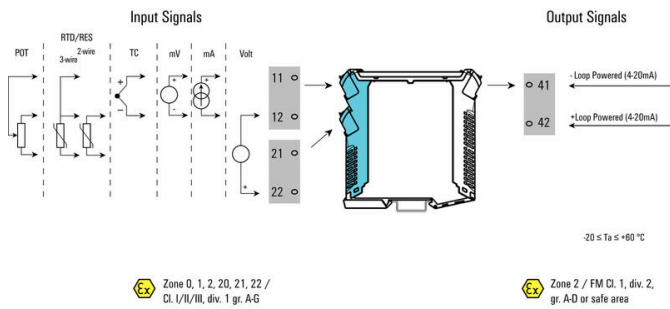

Application

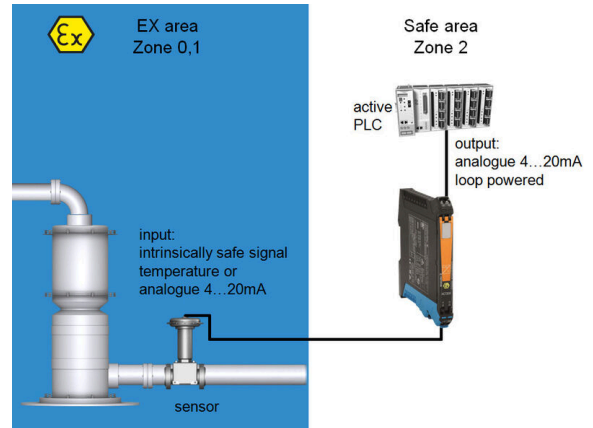

Block diagram

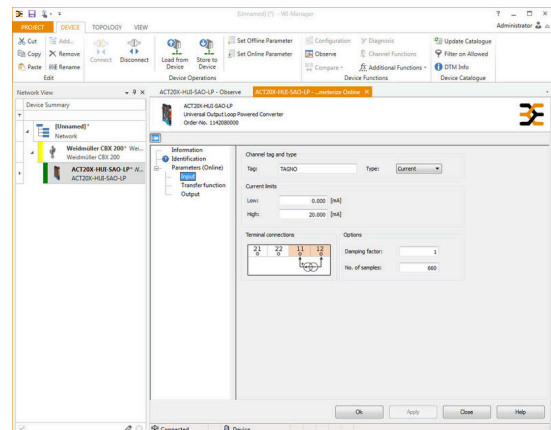
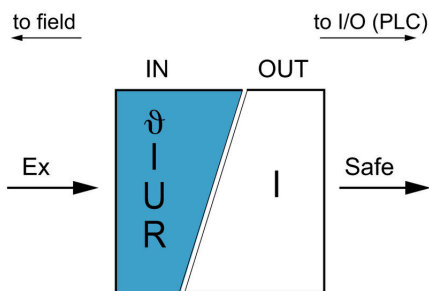

screenshot of temperature input configuration with FDT2 / DTM software

Drawings

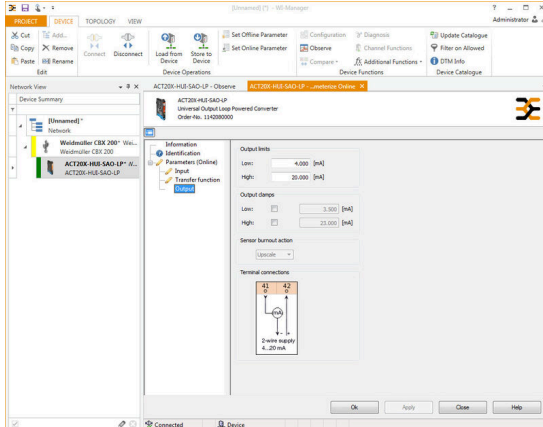

13182200004810.tif

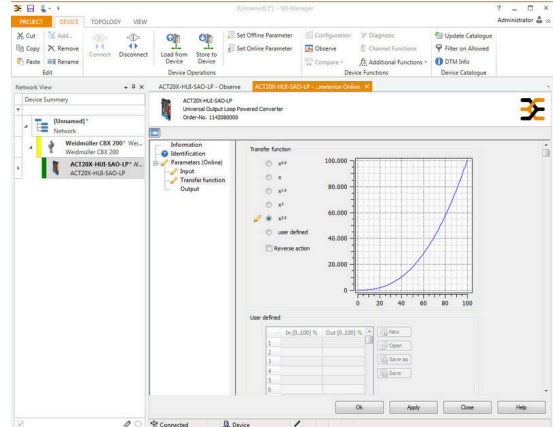

screenshot of output configuration with FDT2 / DTM software

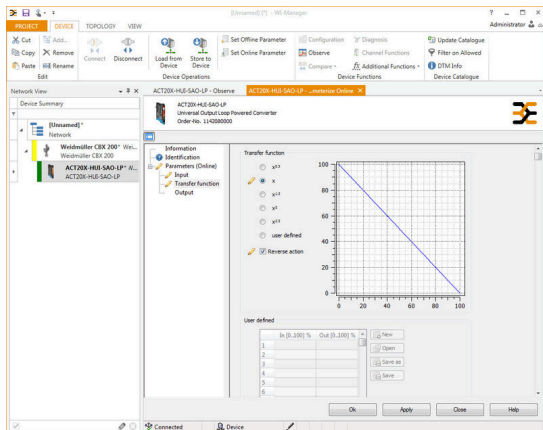

screenshot of transfer function configuration with FDT2 / DTM software

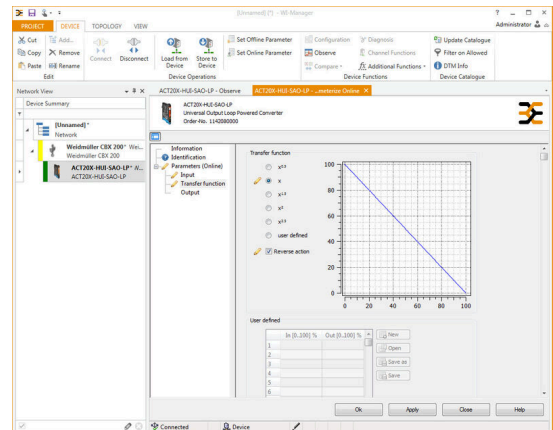

screenshot of transfer function configuration with FDT2 / DTM software

ACT20X-HUI-SAO-LP-S

Weidmüller Interface GmbH & Co. KG
Klingenbergstraße 26
D-32758 Detmold
Germany

Drawings

www.weidmueller.com

Dimensioned drawing

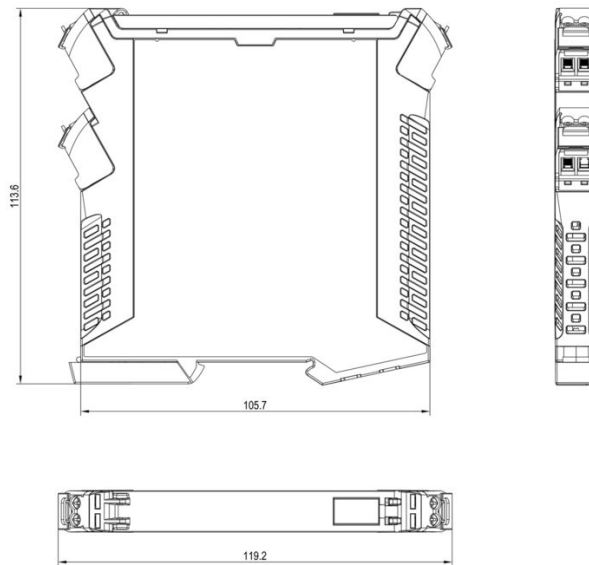



ACT20X-HUI-SAO-LP-S

Weidmüller Interface GmbH & Co. KG
 Klingenbergstraße 26
 D-32758 Detmold
 Germany

www.weidmueller.com

Accessories

Configuration interfaces



General ordering data

Type	CBX200 USB	Version	
Order No.	8978580000		
GTIN (EAN)	4032248813759		
Qty.	1 ST		

Blank

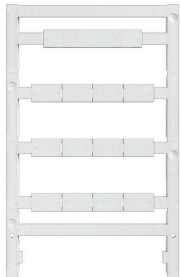

ESG is the tried-and-tested marker in MultiCard format for use on many well-known electrical devices. The result is high-quality device marking with a high-contrast appearance.

Various types are available for devices from manufacturers like Siemens, ABB, Beckhoff etc.

Advantages at a glance:

- Tags for universal usage, self-adhesive or clip-on tags, depending on type
- For aligned equipment, e.g. circuit breakers, we supply ESG markers for clipping onto tag rails
- Individual laser-quality printing according to specifications

For custom printing: Please send us a file of our labeling software M-Print PRO or M-Print PRO Online (without installation) for your labeling specifications.

General ordering data

Type	ESG 8/13.5/43.3 SAI AU	Version	
Order No.	1912130000	ESG, Device markers x 13.5 mm, PA 66, Colour: Transparent,	
GTIN (EAN)	4032248541164	pluggable	
Qty.	5 ST		
Type	ESG 6.6/11 BHZ 5.00/02	Version	
Order No.	1082490000	ESG, Device markers x 11 mm, PA 66, Colour: white, pluggable	
GTIN (EAN)	4032248845330		
Qty.	200 ST		