

UR20-4AO-UI-16-DIAG

Weidmüller Interface GmbH & Co. KG
 Klingenbergstraße 26
 D-32758 Detmold
 Germany

www.weidmueller.com

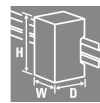

2- or 4-wire connection; 16-bit resolution; 4 outputs
 The analogue output module controls up to 4 analogue actuators with $\pm 10\text{ V}$, $\pm 5\text{ V}$, $0\text{...}10\text{ V}$, $0\text{...}5\text{ V}$, $2\text{...}10\text{ V}$, $1\text{...}5\text{ V}$, $0\text{...}20\text{ mA}$ or $4\text{...}20\text{ mA}$ with an accuracy of 0.05% of the measurement-range end value. An actuator with 2-, 3- or 4-wire technology can be connected to each plug-in connector. The measurement range is defined channel-by-channel using parameterisation. In addition, each channel has its own status LED.
 The outputs are supplied from the output current path (UOUT).

General ordering data

Version	Remote I/O module, IP20, Analog signals, Output, 4-channel, Current/Voltage
Order No.	1315730000
Type	UR20-4AO-UI-16-DIAG
GTIN (EAN)	4050118118667
Qty.	1 items

UR20-4AO-UI-16-DIAG

Weidmüller Interface GmbH & Co. KG
 Klingenbergstraße 26
 D-32758 Detmold
 Germany

www.weidmueller.com

Technical data

Approvals

Approvals



ROHS	Conform
UL File Number Search	UL Website
Certificate no. (cULus)	E141197
Certificate no. (cULusEX)	E223527

Dimensions and weights

Depth	76 mm	Depth (inches)	2.9921 inch
Height	120 mm	Height (inches)	4.7244 inch
Width	11.5 mm	Width (inches)	0.4528 inch
Mounting dimension - height	128 mm	Net weight	86 g

Temperatures

Storage temperature	-40 °C ... +85 °C	Operating temperature	-20 °C...60 °C
---------------------	-------------------	-----------------------	----------------

Environmental Product Compliance

RoHS Compliance Status	Compliant with exemption		
RoHS Exemption (if applicable/known)	7a, 7cl		
REACH SVHC	Lead 7439-92-1		
SCIP	82327f13-cd27-455a-ab5b-a62e1996dcf8		
Product Carbon Footprint	Cradle to gate	8,705 kg CO2 eq.	

analogue outputs

Short-circuit-proof	Yes		
load impedance voltage	> 1 kΩ (at >50 °C ambient temperature, max. total sensor current = 25 mA)		
Load impedance current	<600 Ω		
Repeat accuracy	<1 mV eff.		
Accuracy	±0,1 % FSR max., 0,05 % FSR typ.		
Type	1. U (0...5 V, 0...10 V, 1...5 V, 2...10 V, ±10 V), 2. I (0-20 mA or 4-20 mA)		
Resolution	16 Bit		
Temperature coefficient	20 ppm voltage / 31 ppm current measurement / °K		
Simultaneity factor	min.	0 %	
	nominal	100 %	
	max.	100 %	
Number analogue outputs	4		
Module diagnosis	Yes		
Individual channel diagnosis	Yes		
Output variable	Voltage (0...5 V, 0...10 V, 1...5 V, 2...10 V, ±10 V, ±5 V), Current (0...20 mA or 4...20 mA)		
Response time	1 ms / 4 channels		
Output current as per application	min.	0 mA	

UR20-4AO-UI-16-DIAG

Weidmüller Interface GmbH & Co. KG
 Klingenbergstraße 26
 D-32758 Detmold
 Germany

www.weidmueller.com

Technical data

	nominal	185 mA
	max.	185 mA
Monotonicity	Yes	
Cross-talk between the channels in FSR	0.001 %	
Actuator connection	2-wire (automatic detection), 4-wire	
Actuator supply	min.	0 mA
	nominal	185 mA
	max.	185 mA
Max. error between T min. and T max. in FSR	220 %	
Substitute values	Yes	

Connection data

Wire cross-section, finely stranded, max. (AWG)	AWG 16	Wire cross-section, finely stranded, min. (AWG)	AWG 26
Wire cross-section, solid, max. (AWG)	AWG 16	Wire cross-section, solid, min. (AWG)	AWG 26
Type of connection	PUSH IN		
Wire cross-section, solid, min.	0.14 mm ²	Wire connection cross section, finely stranded, max.	1.5 mm ²
Wire connection cross section, finely stranded, min.	0.14 mm ²		

General data

Vibration resistance	5 Hz ≤ f ≤ 8.4 Hz: 3.5-mm amplitude as per IEC 60068-2-6, 8.4 Hz ≤ f ≤ 150 Hz: 1 g acceleration as per IEC 60068-2-6	UL 94 flammability rating	V-0
Test voltage	500 V	Surge voltage category	II
Pollution severity	2	Mounting rail	TS 35
Air pressure (operation)	≥ 795 hPa (height ≤ 2000 m) as per DIN EN 61131-2	Air humidity (transport)	10% to 95%, non-condensing as per DIN EN 61131-2
Air pressure (transport)	1013 hPa (height 0 m) to 700 hPa (height 3000 m) as per DIN EN 61131-2	Air pressure (storage)	1013 hPa (height 0 m) to 700 hPa (height 3000 m) as per DIN EN 61131-2
Air humidity (operation)	10% to 95%, non-condensing as per DIN EN 61131-2	Air humidity (storage)	10% to 95%, non-condensing as per DIN EN 61131-2
Shock	15 g over 11 ms, half sinus wave, acc. to IEC 60068-2-27		

Power supply

Supply voltage	24 V DC +20 %/ -15 %, via the system bus	Current consumption from I _{sys} , typ.	8 mA
Current consumption from IO _{UT} (the respective power segment)	85 mA		

System data

Module type	Analogue output module	Interface	u-remote system bus
Galvanic isolation	500 V DC between the current paths	Process data	8 Byte
Connection type	PUSH IN	Field bus protocol	PROFINET IRT, PROFINET RT, PROFIBUS DP-V1, EtherCAT, Modbus/TCP, EtherNet/IP, CANopen,

UR20-4AO-UI-16-DIAG

Weidmüller Interface GmbH & Co. KG
Klingenbergstraße 26
D-32758 Detmold
Germany

www.weidmueller.com

Technical data

Transmission speed of system bus, max. 48 MBit/s	Diagnostic data	DeviceNet, POWERLINK, CC-Link, CC-Link IE TSN 2 Bit
--	-----------------	---

Classifications

ETIM 8.0	EC001596	ETIM 9.0	EC001596
ETIM 10.0	EC001596	ECLASS 14.0	27-24-26-01
ECLASS 15.0	27-24-26-01		

UR20-4AO-UI-16-DIAG

Weidmüller Interface GmbH & Co. KG
 Klingenbergstraße 26
 D-32758 Detmold
 Germany

Drawings

www.weidmueller.com

Block diagram

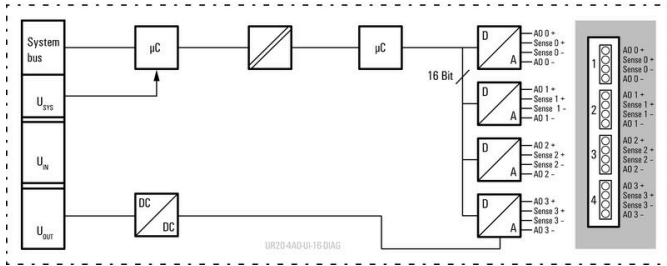

Connection diagram

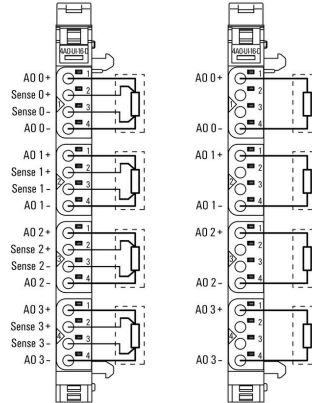

Explanation of abbreviations

Analogue output modules

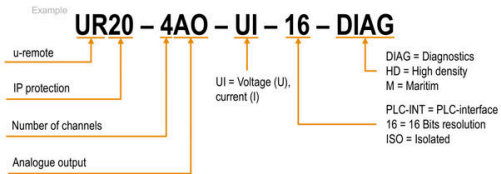

UR20-4AO-UI-16-DIAG

Weidmüller Interface GmbH & Co. KG
 Klingenbergstraße 26
 D-32758 Detmold
 Germany

www.weidmueller.com

Accessories

Accessories

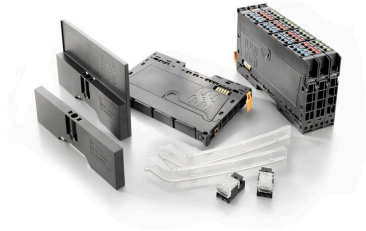

System accessory

Discover a wide range of accessories for your u-remote system - the ideal addition to make your applications even more efficient and flexible.

General ordering data

Type	UR20-EBK-ACC	Version
Order No.	1346610000	End bracket, ,
GTIN (EAN)	4050118151596	
Qty.	5 ST	

Type	UR20-SM-ACC	Version
Order No.	1339920000	Cover, ,
GTIN (EAN)	4050118144727	
Qty.	20 ST	

Blank

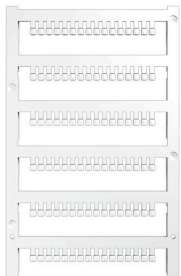

General ordering data

Type	PM 2.7/2.6 MC NE WS	Version
Order No.	1323710000	OMNIMATE Signal - series PM, Pusher markers, 2.7 x 2.6 mm, Pitch
GTIN (EAN)	4050118126778	in mm (P): 3.50 Weidmueller, white
Qty.	960 ST	

Custom printing



UR20-4AO-UI-16-DIAG

Weidmüller Interface GmbH & Co. KG
 Klingenbergstraße 26
 D-32758 Detmold
 Germany

www.weidmueller.com

Accessories

General ordering data

Type	PM 2.7/2.6 MC SDR	Version	
Order No.	1323700000	OMNIMATE Signal - series PM, Pusher markers, 2.7 x 2.6 mm, Pitch in mm (P): 3.50 Weidmueller, To customer specification	
GTIN (EAN)	4050118126761		
Qty.	192 ST		
Type	DEK 5/8-11.5 MC SDR	Version	
Order No.	1341610000	Dekafix, Terminal marker, 5 x 8 mm, Pitch in mm (P): 8.00 Weidmueller, To customer specification	
GTIN (EAN)	4050118146059		
Qty.	100 ST		

Blank



The Dekafix (DEK) marker is the universal marker for all conductor and plug-in connectors as well as for electronic sub-assemblies. The system is ideal for short number sequences and covers a wide range of ready-printed markers.

Strips for fast installation in only one work step. The printing is easy to read, rich in contrast and available in various widths.

- Large range of ready-to-use markers
 - Strips for fast installation
 - Terminal markers, suitable for all Weidmüller cable connectors
 - Available as blank MultiCard or with standard printing
- For custom printing: Please send us a file of our labeling software M-Print PRO or M-Print PRO Online (without installation) for your labeling specifications.

General ordering data

Type	DEK 5/8-11.5 MC NE WS	Version	
Order No.	1341630000	Dekafix, Terminal marker, 5 x 8 mm, Pitch in mm (P): 8.00 Weidmueller, white	
GTIN (EAN)	4050118145946		
Qty.	500 ST		

Aluminum



Aluminum has the second best electrical conductivity after copper. One advantage is low weight, anMiscellaneous is outstanding corrosion protection.

General ordering data

Type	TS 35X7.5 2M/AL/BK	Version	
Order No.	0330800000	Terminal rail, Accessories, Aluminium, untreated, Width: 2000 mm, Height: 35 mm, Depth: 7.5 mm	
GTIN (EAN)	4008190100650		
Qty.	40 M		

UR20-4AO-UI-16-DIAG

Weidmüller Interface GmbH & Co. KG
 Klingenbergstraße 26
 D-32758 Detmold
 Germany

www.weidmueller.com

Accessories

Stainless steel



Stainless steel is a collective term for all types of steel (alloys) with a high degree of purity and corrosion resistance.

General ordering data

Type	TS 35X7.5 2M/CRN	Version	
Order No.	1747350000	Terminal rail, Accessories, Stainless steel 1.4301, untreated, Width:	
GTIN (EAN)	4032248003372	2000 mm, Height: 35 mm, Depth: 7.5 mm	
Qty.	40 M		

Steel



Steel DIN rails are the most widespread on the market. Among metal DIN rails, they have the lowest shortcircuit protection, similar to stainless steel.

General ordering data

Type	TS 35X7.5 2M/ST/ZN	Version	
Order No.	0383400000	Terminal rail, Accessories, Steel, galvanic zinc plated and passivated,	
GTIN (EAN)	4008190088026	Width: 2000 mm, Height: 35 mm, Depth: 7.5 mm	
Qty.	40 M		
Type	TS 35X7.5/LL 2M/ST/ZN	Version	
Order No.	0514500000	Terminal rail, Accessories, Steel, galvanic zinc plated and passivated,	
GTIN (EAN)	4008190046019	Width: 2000 mm, Height: 35 mm, Depth: 7.5 mm	
Qty.	40 M		
Type	TS 35X7.5/LL 1M/ST/ZN	Version	
Order No.	0514510000	Terminal rail, Accessories, Steel, galvanic zinc plated and passivated,	
GTIN (EAN)	4008190116620	Width: 1000 mm, Height: 35 mm, Depth: 7.5 mm	
Qty.	20 M		
Type	TS 35X7.5/LL 2M/ST/SZ	Version	
Order No.	7915060000	Terminal rail, Accessories, Steel, galvanic zinc plated and passivated,	
GTIN (EAN)	4032248296279	Width: 2000 mm, Height: 35 mm, Depth: 7.5 mm	
Qty.	40 M		

UR20-4AO-UI-16-DIAG

Weidmüller Interface GmbH & Co. KG
 Klingenbergstraße 26
 D-32758 Detmold
 Germany

www.weidmueller.com

Accessories

Crimping tools



Crimping tools for wire end ferrules, with and without plastic collars

- Ratchet guarantees precise crimping
- Release option in the event of incorrect operation

General ordering data

Type	PZ 2.5 S	Version	
Order No.	2903690000		0.14mm ² , 2.5mm ² , Trapezoidal crimp
GTIN (EAN)	4099986027008		
Qty.	1 ST		

Basic modules



General ordering data

Type	UR20-BM-SP	Version	
Order No.	1350930000		Replacement part , Flange-mounted housing
GTIN (EAN)	4050118402735		
Qty.	5 ST		

Plugkit

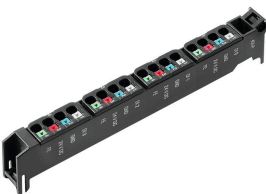

General ordering data

Type	UR20-PK-1315730000-SP	Version	
Order No.	1518880000		Replacement part
GTIN (EAN)	4050118326512		
Qty.	5 ST		

UR20-4AO-UI-16-DIAG

Weidmüller Interface GmbH & Co. KG
Klingenbergstraße 26
D-32758 Detmold
Germany

Accessories

www.weidmueller.com

Electronic modules

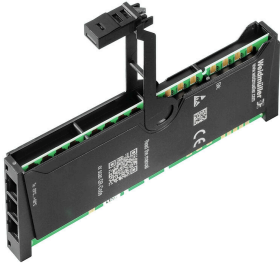

General ordering data

Type	UR20-EM-1315730000-SP	Version	
Order No.	1347330000	Replacement part	
GTIN (EAN)	4050118152012		
Qty.	1 ST		