

## SCS 24VDC P1SIL3DS MG3

**Weidmüller Interface GmbH & Co. KG**  
 Klingenbergstraße 26  
 D-32758 Detmold  
 Germany

www.weidmueller.com



This safety relay is used in areas of process automation that require a functionally safe switch-off. The module meets the requirements for SIL3 according to EN 61508.

- Variant with monitoring circuit
- TUV certified and with "Approved Safety Function"
- cULus certified
- Multi-voltage input (24 - 230 V UC) in the monitoring circuit
- Available with G3 paint according to EN 60068-2-60
- Externally accessible fuse

### General ordering data

Version	SAFESERIES, Safety relay, 24 V DC $\pm$ 20%, 35 mA, Max. switching current, internal fuse : 5 A (refer to derating curve), SIL 3, EN 61508:2010
Order No.	<a href="#">1304040000</a>
Type	SCS 24VDC P1SIL3DS MG3
GTIN (EAN)	4050118103229
Qty.	1 items

## SCS 24VDC P1SIL3DS MG3

Weidmüller Interface GmbH &amp; Co. KG

Klingenbergstraße 26

D-32758 Detmold

Germany

www.weidmueller.com

## Technical data

## Approvals

Approvals



ROHS Conform

UL File Number Search [UL Website](#)

Certificate no. (cULus) E223474

## Dimensions and weights

Depth	114.1 mm	Depth (inches)	4.4921 inch
Height	117.3 mm	Height (inches)	4.6181 inch
Width	22.5 mm	Width (inches)	0.8858 inch
Net weight	200 g		

## Temperatures

Storage temperature	-40 °C...85 °C	Ambient temperature	-25 °C...50 °C
Operating temperature		Humidity	40 °C / 93 % rel. humidity, no condensation

## Environmental Product Compliance

RoHS Compliance Status	Compliant with exemption
RoHS Exemption (if applicable/known)	7a, 7cl
REACH SVHC	Lead 7439-92-1
SCIP	807f1906-ce90-4f93-8801-4b128b343e6b

## Input (safety circuit)

Connection designation (safety circuit)	A1, A2	Rated control voltage	24 V DC $\pm$ 20%
Current consumption	42 mA	Guaranteed current consumption of 24 VDC -10%	35 mA
Inrush current	<250 mA / <5 ms	Status indicator	LED yellow
Protective circuit	Reverse polarity protection, Free-wheeling diode		

## Input (monitoring)

Rated control voltage	24 V UC...230 V UC $\pm$ 10 %	Current consumption	23 mA @ 24 V DC, 4,4 mA @ 230 V AC
Status indicator	LED yellow	Protective circuit	Rectifier

## Output (safety circuit)

Connection designation (safety output)	13, 14, 15	Contact design	1 x de-energised to safe (NO contact)
Contact base material	AgNi 0.15 gold flashed	Max. permitted switching voltage	250 V AC / 30 V DC
Max. permitted switching current	5 A	Max. switching current, internal fuse	5 A (refer to derating curve)
Max. switching current, external fuse	5 A (refer to derating curve)	Max. switching capacity	1250 VA
Internal fuse	5 A time-lag	External back-up fuse	5 A time-lag
Short circuit resistance	No	Switch-on time	typ. 7 ms
Switch-off time	typ. 14 ms	Min. switching capacity	10 mA @ 12 V

## SCS 24VDC P1SIL3DS MG3

Weidmüller Interface GmbH &amp; Co. KG

Klingenbergstraße 26

D-32758 Detmold

Germany

www.weidmueller.com

## Technical data

## Output (monitoring)

Contact design	CO contact	Contact base material	AgNi 5µm Au
Max. permitted switching voltage	24 V DC	Max. allowed switching current	30 mA
Switch-on time	typ. 17 ms	Short circuit resistant	No
Min. switching capacity	1 mA @ 1 V		

## Safety-related basic specifications

Tproof	12 a	Device type	A
Hardware fault tolerance (HFT)	2	Safety category	SIL 3
Safety standard	EN 61508:2010		

## General data

Operating altitude	≤ 2000 m, above sea level	Mounting rail	TS 35
Colour	black, yellow	Noxious gas resistance to EN 60068-2-60	Yes (art. No.: 1304040000 only)

## Insulation coordination

Rated voltage	300 V	Pollution severity	2
Surge voltage category	III	Clearance and creepage distances for control side - load side	≥ 5.5 mm
Dielectric strength for control side - load side	4 kVeff / 1 min	Dielectric strength to mounting rail	4 kVeff / 1 Min.
Impulse withstand voltage	6 kV (1.2/50 µs)	Protection degree	IP20

## Further details of approvals / standards

Standards	EN 61000, EN 61326-3-2	Certificate no. (cULus)	E223474
-----------	------------------------	-------------------------	---------

## Connection data

Wire connection method	Screw connection	Stripping length, rated connection	8 mm
Tightening torque, min.	0.4 Nm	Tightening torque, max.	0.6 Nm
Clamping range, rated connection	1.5 mm <sup>2</sup>	Clamping range, min.	0.13 mm <sup>2</sup>
Clamping range, max.	2.5 mm <sup>2</sup>	Wire connection cross section AWG, min.	AWG 26
Wire connection cross section AWG, max.	AWG 12	Wire cross-section, solid, min.	0.2 mm <sup>2</sup>
Wire cross-section, solid, max.	2.5 mm <sup>2</sup>	Wire connection cross section, finely stranded, min.	0.2 mm <sup>2</sup>
Wire connection cross section, finely stranded, max.	2.5 mm <sup>2</sup>	Wire connection cross-section, finely stranded with wire-end ferrules DIN 46228/4, min.	0.2 mm <sup>2</sup>
Wire connection cross-section, finely stranded with wire-end ferrules DIN 46228/4, max.	2.5 mm <sup>2</sup>	Conductor cross-section, flexible, AEH (DIN 46228-1), min.	0.2 mm <sup>2</sup>
Conductor cross-section, flexible, AEH (DIN 46228-1), max.	2.5 mm <sup>2</sup>	Blade size	size PHO

## Classifications

ETIM 8.0	EC001449	ETIM 9.0	EC001449
ETIM 10.0	EC001449	ECLASS 14.0	27-37-18-19
ECLASS 15.0	27-37-18-19		

SCS 24VDC P1SIL3DS MG3

Weidmüller Interface GmbH & Co. KG  
 Klingenbergstraße 26  
 D-32758 Detmold  
 Germany

Drawings

www.weidmueller.com

Wiring diagram

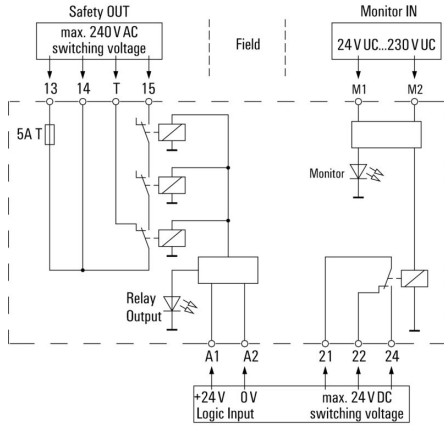

Derating curve

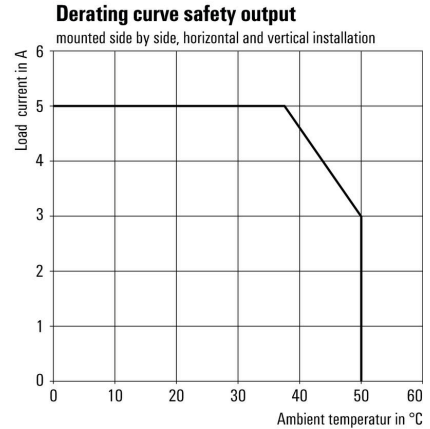

DC load limit curve

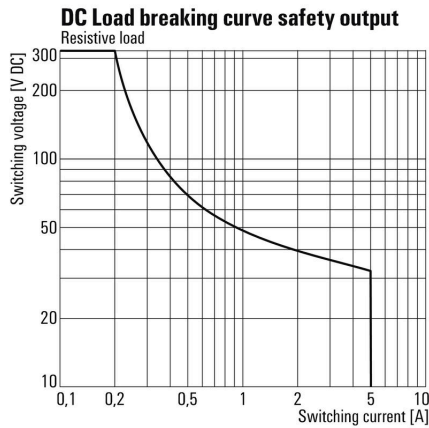

Dimensioned drawing

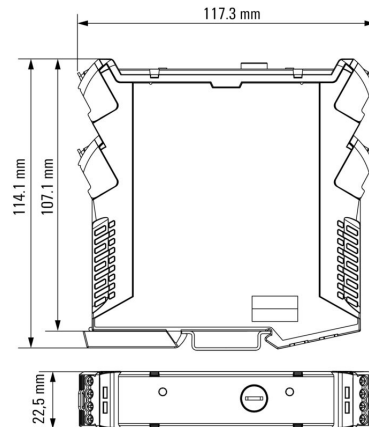

**SCS 24VDC P1SIL3DS MG3**

**Weidmüller Interface GmbH & Co. KG**  
 Klingenbergstraße 26  
 D-32758 Detmold  
 Germany

**Drawings**

www.weidmueller.com

**Miscellaneous**

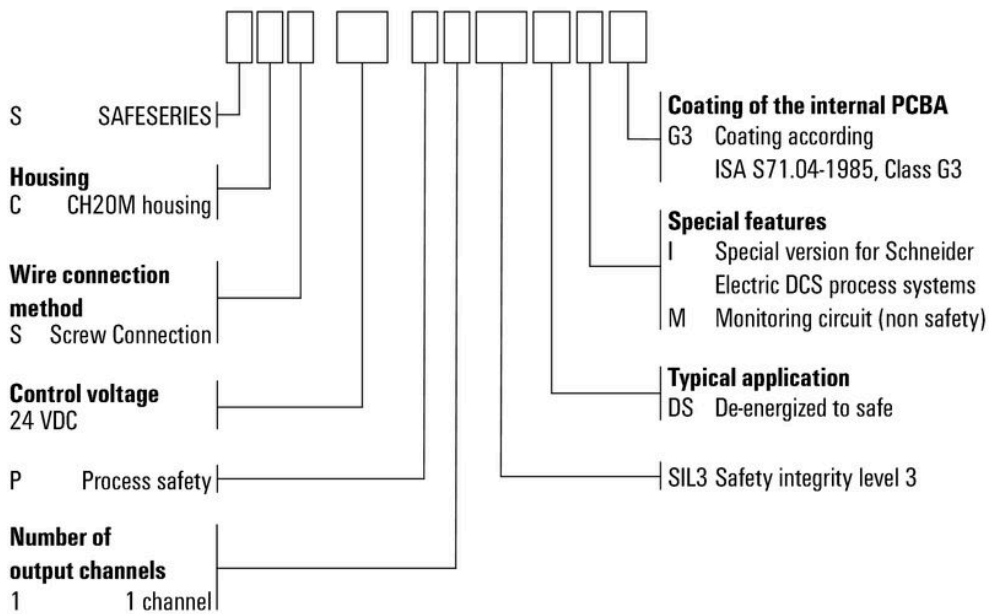

Type codes

## SCS 24VDC P1SIL3DS MG3

**Weidmüller Interface GmbH & Co. KG**  
 Klingenbergstraße 26  
 D-32758 Detmold  
 Germany

www.weidmueller.com

## Accessories

## Blank



ESG is the tried-and-tested marker in MultiCard format for use on many well-known electrical devices. The result is high-quality device marking with a high-contrast appearance.

Various types are available for devices from manufacturers like Siemens, ABB, Beckhoff etc.

Advantages at a glance:

- Tags for universal usage, self-adhesive or clip-on tags, depending on type
- For aligned equipment, e.g. circuit breakers, we supply ESG markers for clipping onto tag rails
- Individual laser-quality printing according to specifications

For custom printing: Please send us a file of our labeling software M-Print PRO or M-Print PRO Online (without installation) for your labeling specifications.

## General ordering data

Type	ESG 6.6/20 BHZ 5.00/04	Version	
Order No.	<a href="#">1082540000</a>	ESG, Device markers x 20 mm, PA 66, Colour: white, pluggable	
GTIN (EAN)	4032248845439		
Qty.	200 ST		

## Blank, adhesive backing



SM is a MultiCard marker for labelling control and signalling devices. The tags are clipped into the carriers or attached by means of the adhesive film already fitted to them. Customised tags can be created with the PrintJet CONNECT or Plotter marking systems.

- Users can quickly produce tags to suit their needs
- No need to stock expensive standard tags
- Highly resistant printing quality when using the PrintJet as a substitute for engraving
- For extreme demands, we recommend the ETO SM protective film
- Holders can be used for the 22-mm or 30-mm-diameter push-buttons from Siemens, ABB, Moeller and Télémécanique

For custom printing: Please send us a file of our labeling software M-Print PRO or M-Print PRO Online (without installation) for your labeling specifications.

## General ordering data

Type	SM 18/9.5 K MC NE GE	Version	
Order No.	<a href="#">1248590000</a>	SwitchMark, Device markers, 9.5 x 18 mm, Siemens 3 SB, yellow	
GTIN (EAN)	4050118038958		
Qty.	200 ST		
Type	SM 18/9.5 K MC NE GR	Version	
Order No.	<a href="#">1248610000</a>	SwitchMark, Device markers, 9.5 x 18 mm, grey	
GTIN (EAN)	4050118038675		
Qty.	200 ST		

## SCS 24VDC P1SIL3DS MG3

Weidmüller Interface GmbH &amp; Co. KG

Klingenbergstraße 26

D-32758 Detmold

Germany

www.weidmueller.com

## Accessories

Type	SM 18/9.5 K MC NE WS	Version	
Order No.	<a href="#">1248580000</a>	SwitchMark, Device markers, 9.5 x 18 mm, white	
GTIN (EAN)	4050118038965		
Qty.	200 ST		

## Blank

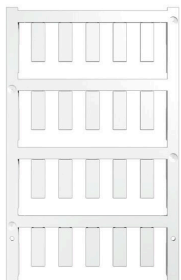

ESG is the tried-and-tested marker in MultiCard format for use on many well-known electrical devices. The result is high-quality device marking with a high-contrast appearance.

Various types are available for devices from manufacturers like Siemens, ABB, Beckhoff etc.

Advantages at a glance:

- Tags for universal usage, self-adhesive or clip-on tags, depending on type
- For aligned equipment, e.g. circuit breakers, we supply ESG markers for clipping onto tag rails
- Individual laser-quality printing according to specifications

For custom printing: Please send us a file of our labeling software M-Print PRO or M-Print PRO Online (without installation) for your labeling specifications.

## General ordering data

Type	ESG 6/17 K MC NE WS	Version	
Order No.	<a href="#">1880120000</a>	ESG, Device markers x 17 mm, PA 66, Colour: white, Self-adhesive	
GTIN (EAN)	4032248478804		
Qty.	200 ST		
Type	ESG 6/17 K MC NE GE	Version	
Order No.	<a href="#">1880110000</a>	ESG, Device markers x 17 mm, PA 66, Colour: yellow, Self-adhesive	
GTIN (EAN)	4032248478798		
Qty.	200 ST		
Type	ESG 6/15 K MC NE GE	Version	
Order No.	<a href="#">1880130000</a>	ESG, Device markers x 15 mm, PA 66, Colour: yellow, Self-adhesive	
GTIN (EAN)	4032248478910		
Qty.	200 ST		
Type	ESG 6/15 K MC NE WS	Version	
Order No.	<a href="#">1880100000</a>	ESG, Device markers x 15 mm, PA 66, Colour: white, Self-adhesive	
GTIN (EAN)	4032248478781		
Qty.	200 ST		
Type	ESG 9/11 K MC NE WS	Version	
Order No.	<a href="#">1857440000</a>	ESG, Device markers x 11 mm, PA 66, Colour: white, Self-adhesive	
GTIN (EAN)	4032248402731		
Qty.	200 ST		

## SCS 24VDC P1SIL3DS MG3

**Weidmüller Interface GmbH & Co. KG**  
 Klingenbergstraße 26  
 D-32758 Detmold  
 Germany

www.weidmueller.com

## Accessories

## SM 18/9.5



Prevention of incorrect operation: SM  
 MultiMark device markers can be used with marking materials from different manufacturers. Wherever they are used, they ensure that all components, such as control and signalling devices from different vendors, are clearly assigned.

Your benefits with MultiMark

- "Different materials for various requirements"
- Can be used with equipment from many manufacturers
- Device markers with a familiar design

## General ordering data

Type	SM 18/9.5 MM WS	Version	
Order No.	<a href="#">2006220000</a>	SwitchMark, Device markers, 9 x 18 mm, white	
GTIN (EAN)	4050118391435		
Qty.	1000 ST		
Type	SM 18/9.5 MM GE	Version	
Order No.	<a href="#">2006240000</a>	SwitchMark, Device markers, 9 x 18 mm, yellow	
GTIN (EAN)	4050118390698		
Qty.	1000 ST		
Type	SM 18/9.5 MM GR	Version	
Order No.	<a href="#">2006260000</a>	SwitchMark, Device markers, 9 x 18 mm, grey	
GTIN (EAN)	4050118390964		
Qty.	1000 ST		

## ESG 6/17



Guaranteed long service life: ESG

The multi-colour and multi-format labels have a strong adhesive layer to ensure the best possible adhesion to the underlying surface. Double laminated polyester makes the basic material very thin and yet extremely tear-resistant.

Your benefits with MultiMark

- "Different materials for various requirements"
- Can be used with equipment from many manufacturers
- Device markers with a familiar design

## General ordering data

Type	ESG 6/17 MM WS	Version	
Order No.	<a href="#">2005100000</a>	ESG, Device markers, 6 x 17 mm, white	
GTIN (EAN)	4050118390728		
Qty.	3000 ST		
Type	ESG 6/17 MM GE	Version	
Order No.	<a href="#">2005110000</a>	ESG, Device markers, 6 x 17 mm, yellow	
GTIN (EAN)	4050118390827		
Qty.	3000 ST		

## SCS 24VDC P1SIL3DS MG3

**Weidmüller Interface GmbH & Co. KG**  
 Klingenbergstraße 26  
 D-32758 Detmold  
 Germany

www.weidmueller.com

## Accessories

## White



THM GEW woven-fabric labels are made from a very flexible cotton fabric. Delivery on reels for use with thermal transfer printers enables an adhesive layer which is thicker than that of A4 sheets for office laser printers. Together, this flexibility and the thick adhesive layer ensure higher adhesive strength and enable use on angular or round objects such as e.g. cables or hoses.

## General ordering data

Type	THM GEW 15/6 WS	Version	
Order No.	<a href="#">1059780000</a>	THM, Device markers, 6 x 15 mm, white	
GTIN (EAN)	4032248808175		
Qty.	1 ST		

## Yellow

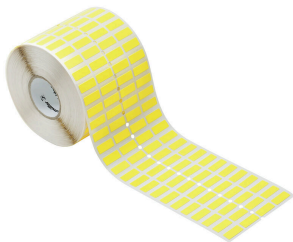

THM GEW woven-fabric labels are made from a very flexible cotton fabric. Delivery on reels for use with thermal transfer printers enables an adhesive layer which is thicker than that of A4 sheets for office laser printers. Together, this flexibility and the thick adhesive layer ensure higher adhesive strength and enable use on angular or round objects such as e.g. cables or hoses.

## General ordering data

Type	THM GEW 15/6 GE	Version	
Order No.	<a href="#">1059790000</a>	THM, Device markers, 6 x 15 mm, yellow	
GTIN (EAN)	4032248808182		
Qty.	1 ST		

## Crosshead screwdriver Phillips



VDE insulated crosshead screwdriver, for Phillips screws, SDIK PH DIN 7438, ISO 8764/2-PH, output to ISO 8764-PH, SoftFinish grip

## General ordering data

Type	SDIK PHO X 60	Version	
Order No.	<a href="#">2749880000</a>	Screwdriver, Blade width (B): 0 mm, 60 mm, Blade thickness (A): 0	
GTIN (EAN)	4050118897081		
Qty.	1 ST		

**SCS 24VDC P1SIL3DS MG3**

**Weidmüller Interface GmbH & Co. KG**  
 Klingenbergstraße 26  
 D-32758 Detmold  
 Germany

www.weidmueller.com

**Accessories**

Type	SDK PH0 X 60	Version	
Order No.	<a href="#">2749400000</a>	Screwdriver, Blade width (B): 3 mm, 60 mm, Blade thickness (A): 0	
GTIN (EAN)	4050118895629		
Qty.	1 ST		

**ESG 6/15**



Guaranteed long service life: ESG

The multi-colour and multi-format labels have a strong adhesive layer to ensure the best possible adhesion to the underlying surface. Double laminated polyester makes the basic material very thin and yet extremely tear-resistant.

Your benefits with MultiMark

- "Different materials for various requirements"
- Can be used with equipment from many manufacturers
- Device markers with a familiar design

**General ordering data**

Type	ESG 6/15 MM WS	Version	
Order No.	<a href="#">2619940000</a>	ESG, Device markers, 6 x 15 mm, white	
GTIN (EAN)	4050118626148		
Qty.	3000 ST		