

PGK 4 BT BK

Weidmüller Interface GmbH & Co. KG

Klingenbergstraße 26

D-32758 Detmold

Germany

www.weidmueller.com

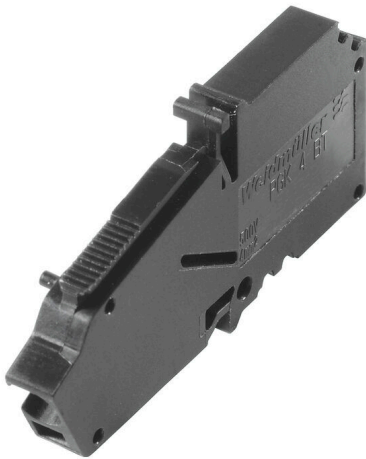

The PGK 4 device feed-through terminal is the fastest and most compact solution for feed-throughs in housings. The innovative PUSH IN connection system from Weidmüller makes for a simple, tool-free wire connection on the inside and outside of devices. The sliced design and an intuitive fastening mechanism enable high-density blocks to be constructed quickly and easily.

General ordering data

Version	OMNIMATE Power - series PGK, Feed-through terminal, Rated cross-section: 4 mm ² , Wemid (PA), Direct mounting, Feed-through (bushing)
Order No.	1288590000
Type	PGK 4 BT BK
GTIN (EAN)	4050118079845
Qty.	100 items
Product data	IEC: 500 V / 32 A / 0.5 - 4 mm ² UL: 300 V / 30 A / AWG 24 - AWG 10
Packaging	Box

PGK 4 BT BK

Weidmüller Interface GmbH & Co. KG

Klingenbergstraße 26

D-32758 Detmold

Germany

www.weidmueller.com

Technical data

Approvals

Approvals



ROHS	Conform
UL File Number Search	UL Website
Certificate No. (cURus)	E60693

Dimensions and weights

Height	24.3 mm	Height (inches)	0.9567 inch
Height of lowest version	24.3 mm	Width	5.1 mm
Width (inches)	0.2008 inch	Length	5.1 mm
Length (inches)	0.2008 inch	Net weight	6.27 g

Environmental Product Compliance

RoHS Compliance Status	Compliant without exemption
REACH SVHC	No SVHC above 0.1 wt%

System parameters

Product family	OMNIMATE Power - series PGK	Wire connection method	PUSH IN without actuator
Conductor outlet direction	180°	Number of poles	1
Pin series quantity	1	Fitted by customer	Yes
Screwdriver blade	0.4 x 2.5	Stripping length	12 mm
Touch-safe protection acc. to DIN VDE 0470	IP 20	Protection degree	IP20
Type of connection 1	PUSH IN	Type of connection 2	PUSH IN

Material data

Insulating material	Wemid (PA)	Colour	black
Colour chart (similar)	RAL 9011	Moisture Level (MSL)	
UL 94 flammability rating	V-0	Contact material	Cu-alloy
Contact surface	tinned	Storage temperature, min.	-40 °C
Storage temperature, max.	70 °C	Operating temperature, min.	-50 °C
Operating temperature, max.	120 °C	Temperature range, installation, min.	-25 °C
Temperature range, installation, max.	120 °C		

Conductors suitable for connection

Clamping range, min.	0.5 mm ²
Clamping range, max.	4 mm ²
Wire connection cross section AWG, min.	AWG 24
Wire connection cross section AWG, max.	AWG 10
Solid, min. H05(07) V-U	0.5 mm ²
Solid, max. H05(07) V-U	4 mm ²
Flexible, min. H05(07) V-K	0.5 mm ²
Flexible, max. H05(07) V-K	4 mm ²
w. plastic collar ferrule, DIN 46228 pt 4, 0.5 mm ² min.	

PGK 4 BT BK

Weidmüller Interface GmbH & Co. KG

Klingenbergstraße 26
D-32758 Detmold
Germany

www.weidmueller.com

Technical data

w. plastic collar ferrule, DIN 46228 pt 4, 2.5 mm²
max.

w. wire end ferrule, DIN 46228 pt 1,
min. 0.5 mm²

w. wire end ferrule, DIN 46228 pt 1,
max. 4 mm²

Clampable conductor	Cross-section for conductor connection	Type	fine-wired
		nominal	0.5 mm ²
wire end ferrule	Stripping length	nominal	14 mm
		Recommended wire-end ferrule	H0.5/18 OR
Cross-section for conductor connection	Type	fine-wired	
	nominal	1 mm ²	
wire end ferrule	Stripping length	nominal	15 mm
		Recommended wire-end ferrule	H1.0/18 GE
Cross-section for conductor connection	Type	fine-wired	
	nominal	1.5 mm ²	
wire end ferrule	Stripping length	nominal	15 mm
		Recommended wire-end ferrule	H1.5/18D SW
Stripping length	Recommended wire-end ferrule	nominal	12 mm
			H1.5/12
Cross-section for conductor connection	Type	fine-wired	
	nominal	0.75 mm ²	
wire end ferrule	Stripping length	nominal	14 mm
		Recommended wire-end ferrule	H0.75/18 W
Cross-section for conductor connection	Type	fine-wired	
	nominal	2.5 mm ²	
wire end ferrule	Stripping length	nominal	14 mm
		Recommended wire-end ferrule	H2.5/19D BL
Stripping length	Recommended wire-end ferrule	nominal	12 mm
			H2.5/12
Cross-section for conductor connection	Type	fine-wired	
	nominal	4 mm ²	
wire end ferrule	Stripping length	nominal	12 mm
		Recommended wire-end ferrule	H4.0/12

Reference text Length of ferrules is to be chosen depending on the product and the rated voltage., The outside diameter of the plastic collar should not be larger than the pitch (P)

Rated data acc. to IEC

tested acc. to standard	IEC 60664-1	Rated current, min. number of poles (Tu=20°C)	32 A
Rated current, max. number of poles (Tu=20°C)	32 A	Rated voltage for surge voltage class / pollution degree III/3	500 V
Rated impulse voltage for surge voltage class/ contamination degree III/3	6 kV		

Rated data acc. to CSA

Institute (CSA)	CSA	Certificate No. (CSA)	200039-70000589
Rated voltage (Use group B / CSA)	300 V	Rated voltage (Use group C / CSA)	150 V
Rated voltage (Use group D / CSA)	300 V	Rated current (Use group B / CSA)	30 A
Rated current (Use group C / CSA)	30 A	Rated current (Use group D / CSA)	10 A

PGK 4 BT BK

Weidmüller Interface GmbH & Co. KG
 Klingenbergstraße 26
 D-32758 Detmold
 Germany

www.weidmueller.com

Technical data

Wire cross-section, AWG, min.	AWG 24	Wire cross-section, AWG, max.	AWG 10
Reference to approval values	Specifications are maximum values, details - see approval certificate.		

Rated data acc. to UL 1059

Institute (cURus)	CURUS	Certificate No. (cURus)	E60693
Rated voltage (Use group B / UL 1059)	300 V	Rated voltage (Use group C / UL 1059)	150 V
Rated voltage (Use group D / UL 1059)	300 V	Rated current (Use group B / UL 1059)	30 A
Rated current (Use group C / UL 1059)	30 A	Rated current (Use group D / UL 1059)	10 A
Wire cross-section, AWG, min.	AWG 24	Wire cross-section, AWG, max.	AWG 10
Reference to approval values	Specifications are maximum values, details - see approval certificate.		

Packing

Packaging	Box	VPE length	186.00 mm
VPE width	116.00 mm	VPE height	90.00 mm

Important note

Notes	<ul style="list-style-type: none"> • End plate required • Clearance and creepage distances to other components must be devised in accordance with the relevant application standard. This can be achieved in the device by full encapsulation or by the use of additional spacer plates. • Rated data refer only to the component itself. Clearance and creepage distances to other components are to be designed in accordance with the relevant application standards. • Colours: SW = black; GN/YL = green/yellow; GY = grey • Additional variants on request • Long term storage of the product with average temperature of 50 °C and maximum humidity 70%, 36 months
-------	---

Classifications

ETIM 8.0	EC001283	ETIM 9.0	EC001283
ETIM 10.0	EC001283	ECLASS 14.0	27-14-11-34
ECLASS 15.0	27-14-11-34		

Drawings

Dimensional drawing

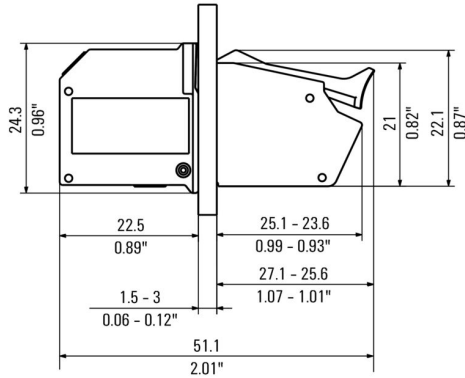

Dimensional drawing

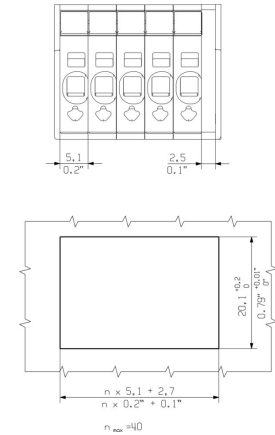

Product benefits

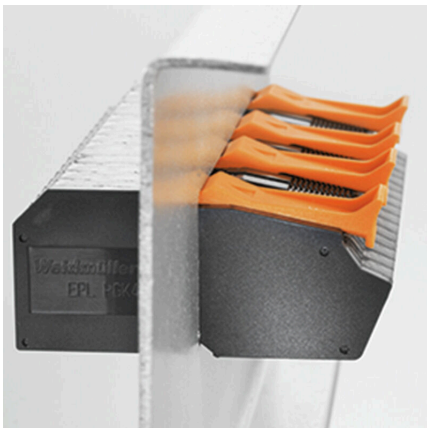

Secure and reliable installation

Product benefits

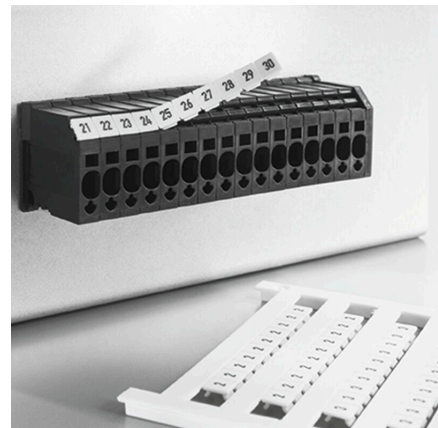

Clear marking position

Product benefits

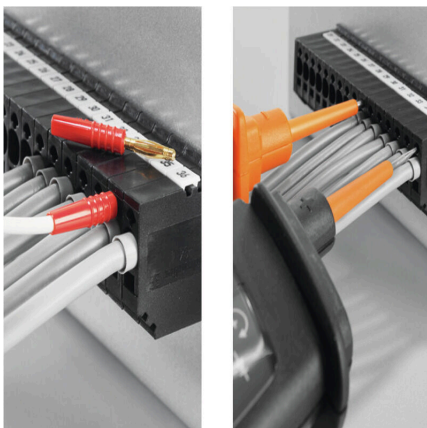

Available test points

Product benefits



Intuitive fastening mechanism Lower assembly costs

Drawings

Product benefits

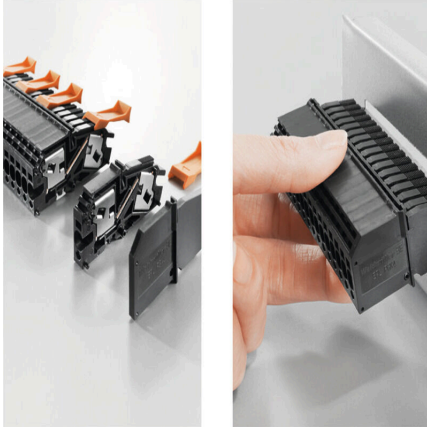

Space-saving with disk design