

B2CF 3.50/34/180LR SN BK BX

Weidmüller Interface GmbH & Co. KG
 Klingenbergstraße 26
 D-32758 Detmold
 Germany

www.weidmueller.com

Product image

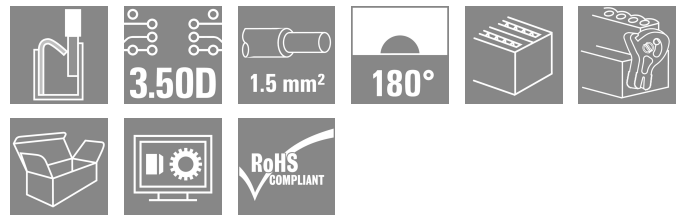
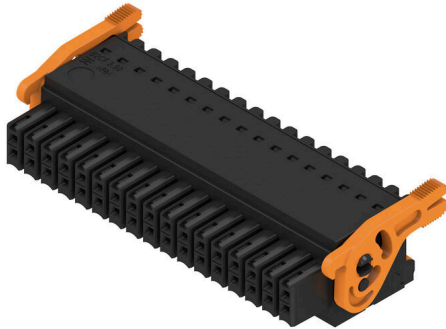

Two-row female plug with PUSH IN spring connection

- Simply insert the prepared wire - and you're done
- Intuitive to use because
- the wire-entry area and handling area are clearly separated
- Integrated push-buttons for opening the terminal point
- High component density because of low heights
- Optional: locking and releasing require no tools when using Weidmüller's release latch (LR) or release lever (LH)

General ordering data

| | |
|--------------|--|
| Version | PCB plug-in connector, female plug, 3.50 mm, Number of poles: 34, 180°, PUSH IN with actuator, Clamping range, max. : 1.5 mm², Box |
| Order No. | 1278400000 |
| Type | B2CF 3.50/34/180LR SN BK BX |
| GTIN (EAN) | 4050118068924 |
| Qty. | 24 items |
| Product data | IEC: 320 V / 13.4 A / 0.14 - 1.5 mm² UL: 300 V / 9.5 A / AWG 30 - AWG 16 |
| Packaging | Box |

B2CF 3.50/34/180LR SN BK BX

Weidmüller Interface GmbH & Co. KG
 Klingenbergstraße 26
 D-32758 Detmold
 Germany

www.weidmueller.com

Technical data**Approvals**

Approvals



| | |
|-------------------------|----------------------------|
| ROHS | Conform |
| UL File Number Search | UL Website |
| Certificate No. (cURus) | E60693 |

Dimensions and weights

| | | | |
|------------|----------|-----------------|-------------|
| Depth | 29.9 mm | Depth (inches) | 1.1772 inch |
| Height | 17.25 mm | Height (inches) | 0.6791 inch |
| Width | 66.4 mm | Width (inches) | 2.6142 inch |
| Net weight | 23.95 g | | |

Environmental Product Compliance

| | | | |
|--------------------------|-----------------------------|-----------------|--|
| RoHS Compliance Status | Compliant without exemption | | |
| REACH SVHC | No SVHC above 0.1 wt% | | |
| Product Carbon Footprint | Cradle to gate | 0.564 kg CO2eq. | |

System Parameters

| | | | |
|--|---|--|--------------------|
| Product family | OMNIMATE Signal - series B2C/S2C 3.50 - 2-row | Type of connection | Field connection |
| Wire connection method | PUSH IN with actuator | Pitch in mm (P) | 3.50 mm |
| Pitch in inches (P) | 0.138 " | Conductor outlet direction | 180° |
| Number of poles | 34 | L1 in mm | 56.00 mm |
| L1 in inches | 2.205 " | Number of rows | 1 |
| Pin series quantity | 2 | Rated cross-section | 15 mm ² |
| Touch-safe protection acc. to DIN VDE 57 106 | Safe from finger touch | Touch-safe protection acc. to DIN VDE 0470 | IP20 plugged |
| Protection degree | IP20, when fully mounted | Can be coded | Yes |
| Stripping length | 10 mm | Screwdriver blade | 0.4 x 2.5 |
| Screwdriver blade standard | DIN 5264 | Plugging cycles | 25 |
| Plugging force/pole, max. | 3.5 N | Pulling force/pole, max. | 3.5 N |

Material data

| | | | |
|---------------------------------------|-------------|---------------------------------------|----------------------------|
| Insulating material | PA 66 GF 30 | Colour | black |
| Colour of operational elements | orange | Colour chart (similar) | RAL 9011 |
| Insulating material group | II | Comparative Tracking Index (CTI) | ≥ 600 |
| Insulation resistance | ≥ 108 Ω | Moisture Level (MSL) | |
| UL 94 flammability rating | V-0 | Contact material | Copper alloy |
| Contact surface | tinned | Layer structure of plug contact | 2...5 μm Sn hot-dip tinned |
| Storage temperature, min. | -40 °C | Storage temperature, max. | 70 °C |
| Operating temperature, min. | -50 °C | Operating temperature, max. | 120 °C |
| Temperature range, installation, min. | -40 °C | Temperature range, installation, max. | 120 °C |

Conductors suitable for connection

| | |
|---|----------------------|
| Clamping range, min. | 0.14 mm ² |
| Clamping range, max. | 1.5 mm ² |
| Wire connection cross section AWG, min. | AWG 30 |

B2CF 3.50/34/180LR SN BK BX

Weidmüller Interface GmbH & Co. KG
 Klingenbergstraße 26
 D-32758 Detmold
 Germany

www.weidmueller.com

Technical data

| | |
|---|----------------------|
| Wire connection cross section AWG, max. | AWG 16 |
| Solid, min. H05(07) V-U | 0.14 mm ² |
| Solid, max. H05(07) V-U | 1.5 mm ² |
| Flexible, min. H05(07) V-K | 0.14 mm ² |
| Flexible, max. H05(07) V-K | 1.5 mm ² |
| w. plastic collar ferrule, DIN 46228 pt 4, min. | 0.14 mm ² |
| w. plastic collar ferrule, DIN 46228 pt 4, max. | 1 mm ² |
| w. wire end ferrule, DIN 46228 pt 1, min. | 0.14 mm ² |
| w. wire end ferrule, DIN 46228 pt 1, max. | 1.5 mm ² |

| Clampable conductor | Cross-section for conductor connection | |
|--|--|---------------------------------|
| | wire end ferrule | nominal 0.14 mm ² |
| wire end ferrule | Stripping length | nominal 10 mm |
| | Recommended wire-end ferrule | H0.14/12 GR SV |
| Cross-section for conductor connection | nominal | 0.25 mm ² |
| | wire end ferrule | nominal 10 mm |
| wire end ferrule | Stripping length | nominal 10 mm |
| | Recommended wire-end ferrule | H0.25/12 HBL SV |
| Cross-section for conductor connection | nominal | 0.34 mm ² |
| | wire end ferrule | nominal 10 mm |
| wire end ferrule | Stripping length | nominal 10 mm |
| | Recommended wire-end ferrule | H0.34/12 TK SV |
| Cross-section for conductor connection | nominal | 0.5 mm ² |
| | wire end ferrule | nominal 12 mm |
| wire end ferrule | Stripping length | nominal 12 mm |
| | Recommended wire-end ferrule | H0.5/16 OR SV |
| wire end ferrule | Stripping length | nominal 10 mm |
| | Recommended wire-end ferrule | H0.5/10 |
| Cross-section for conductor connection | nominal | 0.75 mm ² |
| | wire end ferrule | nominal 12 mm |
| wire end ferrule | Stripping length | nominal 12 mm |
| | Recommended wire-end ferrule | H0.75/16 W SV |
| wire end ferrule | Stripping length | nominal 10 mm |
| | Recommended wire-end ferrule | H0.75/10 |
| Cross-section for conductor connection | nominal | 1 |
| | wire end ferrule | nominal 12 mm |
| wire end ferrule | Stripping length | nominal 12 mm |
| | Recommended wire-end ferrule | H1.0/16 GE SV |
| wire end ferrule | Stripping length | nominal 10 mm |
| | Recommended wire-end ferrule | H1.0/10 |
| Cross-section for conductor connection | nominal | 1.5 mm ² |
| | wire end ferrule | nominal 10 mm |
| wire end ferrule | Stripping length | nominal 10 mm |
| | Recommended wire-end ferrule | H1.5/10 |

Reference text The outside diameter of the plastic collar should not be larger than the pitch (P), Length of ferrules is to be chosen depending on the product and the rated voltage.

Rated data acc. to IEC

| | | | |
|---|------------------------|---|--------|
| tested acc. to standard | IEC 60664-1, IEC 61984 | Rated current, min. number of poles (Tu=20°C) | 13.4 A |
| Rated current, max. number of poles (Tu=20°C) | 10 A | Rated current, min. number of poles (Tu=40°C) | 12 A |

B2CF 3.50/34/180LR SN BK BX

Weidmüller Interface GmbH & Co. KG
 Klingenbergstraße 26
 D-32758 Detmold
 Germany

www.weidmueller.com

Technical data

| | | | |
|---|--------|---|------------------|
| Rated current, max. number of poles (Tu=40°C) | 9 A | Rated voltage for surge voltage class / pollution degree II/2 | 320 V |
| Rated voltage for surge voltage class / pollution degree III/2 | 160 V | Rated voltage for surge voltage class / pollution degree III/3 | 160 V |
| Rated impulse voltage for surge voltage class/ pollution degree II/2 | 2.5 kV | Rated impulse voltage for surge voltage class/ pollution degree III/2 | 2.5 kV |
| Rated impulse voltage for surge voltage class/ contamination degree III/3 | 2.5 kV | Short-time withstand current resistance | 3 x 1s with 80 A |

Rated data acc. to CSA

| | | | |
|-----------------------------------|--|-----------------------------------|----------------|
| Institute (CSA) | CSA | Certificate No. (CSA) | 200039-1121690 |
| Rated voltage (Use group B / CSA) | 300 V | Rated voltage (Use group C / CSA) | 50 V |
| Rated voltage (Use group D / CSA) | 300 V | Rated current (Use group B / CSA) | 9.5 A |
| Rated current (Use group C / CSA) | 9.5 A | Rated current (Use group D / CSA) | 9.5 A |
| Wire cross-section, AWG, min. | AWG 30 | Wire cross-section, AWG, max. | AWG 16 |
| Reference to approval values | Specifications are maximum values, details - see approval certificate. | | |

Rated data acc. to UL 1059

| | | | |
|---------------------------------------|--|---------------------------------------|--------|
| Institute (cURus) | CURUS | Certificate No. (cURus) | E60693 |
| Rated voltage (Use group B / UL 1059) | 300 V | Rated voltage (Use group C / UL 1059) | 50 V |
| Rated voltage (Use group D / UL 1059) | 300 V | Rated current (Use group B / UL 1059) | 9.5 A |
| Rated current (Use group C / UL 1059) | 9.5 A | Rated current (Use group D / UL 1059) | 9.5 A |
| Wire cross-section, AWG, min. | AWG 30 | Wire cross-section, AWG, max. | AWG 16 |
| Reference to approval values | Specifications are maximum values, details - see approval certificate. | | |

Packing

| | | | |
|-----------|-----------|------------|-----------|
| Packaging | Box | VPE length | 349.00 mm |
| VPE width | 138.00 mm | VPE height | 40.00 mm |

Type tests

| | | | |
|--|----------------|---|----------------------------|
| Test: Durability of markings | Standard | IEC 61984 section 6.2 and 7.3.2 / 10.11 taking pattern from IEC 60068-2-70 / 12.95 | |
| | Test | mark of origin, type identification, pitch, type of material, date clock, approval marking UL, approval marking cULus | |
| | Evaluation | available | |
| | Test | durability | |
| Test: Misengagement (Non-interchangeability) | Evaluation | passed | |
| | Standard | IEC 61984 section 6.3 and 6.9.1 / 10.11, IEC 60512-13-5 / 02.06 | |
| | Test | 180° turned without coding elements | |
| | Evaluation | passed | |
| | Test | 180° turned with coding elements | |
| | Evaluation | passed | |
| Test: Clampable cross section | Standard | IEC 60999-1 section 7 and 9.1 / 11.99, IEC 60947-1 section 8.2.4.5.1 / 03.11 | |
| | Conductor type | Type of conductor | solid 0.14 mm ² |
| | | and conductor cross-section | |

B2CF 3.50/34/180LR SN BK BX

Weidmüller Interface GmbH & Co. KG
 Klingenbergstraße 26
 D-32758 Detmold
 Germany

www.weidmueller.com

Technical data

| | | | |
|---|----------------|---|-------------------------------|
| | | Type of conductor and conductor cross-section | stranded 0.14 mm ² |
| | | Type of conductor and conductor cross-section | solid 1.5 mm ² |
| | | Type of conductor and conductor cross-section | stranded 1.5 mm ² |
| | | Type of conductor and conductor cross-section | AWG 26/1 |
| | | Type of conductor and conductor cross-section | AWG 26/19 |
| | | Type of conductor and conductor cross-section | AWG 16/1 |
| | | Type of conductor and conductor cross-section | AWG 16/19 |
| | Evaluation | passed | |
| | Standard | IEC 60999-1 section 9.4 / 11.99 | |
| | Requirement | 0.2 kg | |
| | Conductor type | Type of conductor and conductor cross-section | AWG 26/1 |
| | | Type of conductor and conductor cross-section | AWG 26/19 |
| | Evaluation | passed | |
| | Requirement | 0.3 kg | |
| | Conductor type | Type of conductor and conductor cross-section | H05V-U0.75 |
| | | Type of conductor and conductor cross-section | H05V-K0.75 |
| | Evaluation | passed | |
| | Requirement | 0.4 kg | |
| | Conductor type | Type of conductor and conductor cross-section | H07V-U1.5 |
| | | Type of conductor and conductor cross-section | H07V-K1.5 |
| | | Type of conductor and conductor cross-section | AWG 16/1 |
| | | Type of conductor and conductor cross-section | AWG 16/19 |
| | Evaluation | passed | |
| | Standard | IEC 60999-1 section 9.5 / 11.99 | |
| | Requirement | ≥10 N | |
| | Conductor type | Type of conductor and conductor cross-section | AWG 26/1 |
| | | Type of conductor and conductor cross-section | AWG 26/19 |
| | Evaluation | passed | |
| | Requirement | ≥20 N | |
| Test for damage to and accidental loosening of conductors | | | |
| Pull-out test | | | |

B2CF 3.50/34/180LR SN BK BX

Weidmüller Interface GmbH & Co. KG
 Klingenbergstraße 26
 D-32758 Detmold
 Germany

www.weidmueller.com

Technical data

| | | |
|----------------|---|------------|
| Conductor type | Type of conductor and conductor cross-section | H05V-U0.75 |
| | Type of conductor and conductor cross-section | H05V-K0.75 |
| Evaluation | passed | |
| Requirement | ≥40 N | |
| Conductor type | Type of conductor and conductor cross-section | H07V-U1.5 |
| | Type of conductor and conductor cross-section | H07V-K1.5 |
| | Type of conductor and conductor cross-section | AWG 16/1 |
| | Type of conductor and conductor cross-section | AWG 16/19 |
| Evaluation | passed | |

Important note

IPC conformity Conformity: The products are developed, manufactured and delivered according international recognized standards and norms and comply with the assured properties in the data sheet resp. fulfill decorative properties in accordance with IPC-A-610 "Class 2". Further claims on the products can be evaluated on request.

- Notes**
- Additional variants on request
 - Gold-plated contact surfaces on request
 - Rated current related to rated cross-section & min. No. of poles.
 - Crimp shape A for wire-end ferrules with crimping tools PZ 1,5 (order no. 9005990000) or PZ 6/5 (order no. 9011460000) for larger wire cross-sections recommended.
 - P on drawing = pitch
 - Rated data refer only to the component itself. Clearance and creepage distances to other components are to be designed in accordance with the relevant application standards.
 - Max. outer diameter of the conductor 2.6 mm
 - In accordance with IEC 61984, OMNIMATE-connectors are connectors without breaking capacity (COC). During designated use, connectors are not allowed to be engaged or disengaged when live or under load
 - Long term storage of the product with average temperature of 50 °C and maximum humidity 70%, 36 months

Classifications

| | | | |
|-------------|-------------|-------------|-------------|
| ETIM 8.0 | EC002638 | ETIM 9.0 | EC002638 |
| ETIM 10.0 | EC002638 | ECLASS 14.0 | 27-46-02-02 |
| ECLASS 15.0 | 27-46-02-02 | | |

B2CF 3.50/34/180LR SN BK BX

Weidmüller Interface GmbH & Co. KG
 Klingenbergstraße 26
 D-32758 Detmold
 Germany

www.weidmueller.com

Drawings

Product image

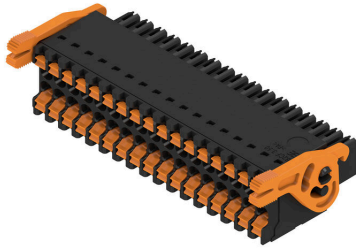

Dimensional drawing

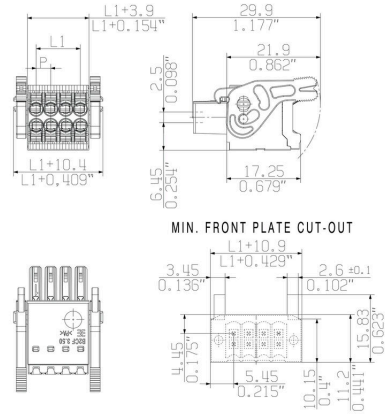

Graph

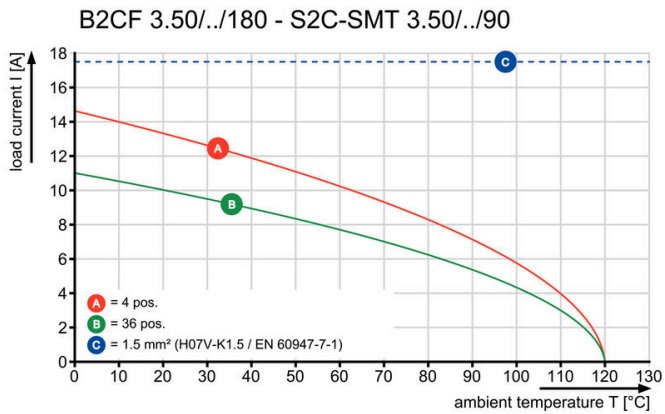

Product benefits

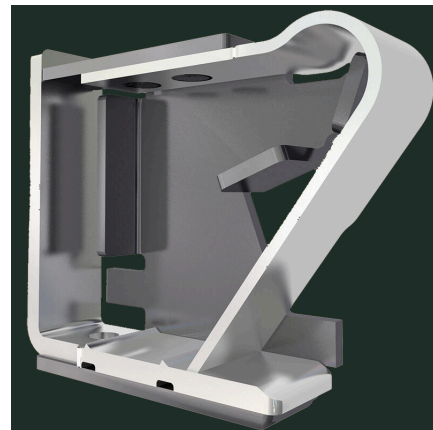

Solid PUSH IN contactSafe and durable

Product benefits

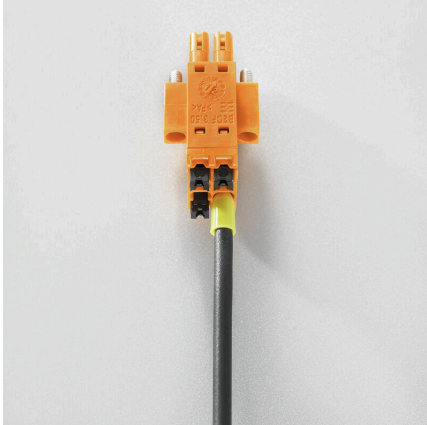

Large connection cross-section Up to 1.5 mm possible with ease

Product benefits

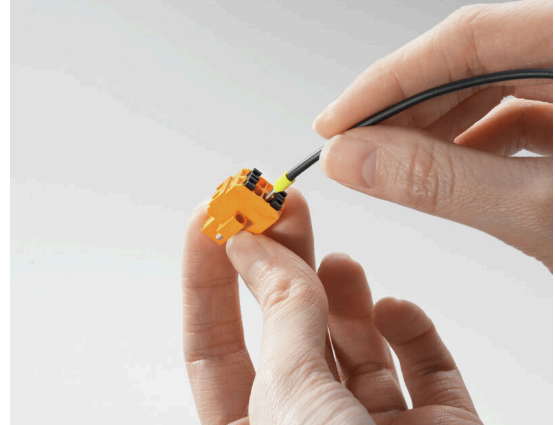

Fast PUSH IN connection Tool-free and touch-safe

Example of use

