

IE-C6FP8LD0010M40W40-D

Weidmüller Interface GmbH & Co. KG
Klingenbergstraße 26
D-32758 Detmold
Germany

www.weidmueller.com



Assembled IE cables, patch cable Cabinet Line, Cat. 6,
LSZH, grey, 270° angled on one side

General ordering data

Version	Patch cable, RJ45 IP 20, Angled 270°, RJ45 IP 20, <20 m: Cat.6A / >20 m Class EA (ISO/IEC 11801 2010), LSZH, 1 m
Order No.	1233160010
Type	IE-C6FP8LD0010M40W40-D
GTIN (EAN)	4050118016772
Qty.	1 items

IE-C6FP8LD0010M40W40-D

Weidmüller Interface GmbH & Co. KG
 Klingenbergstraße 26
 D-32758 Detmold
 Germany

www.weidmueller.com

Technical data

Approvals

Approvals



ROHS Conform

UL File Number Search [UL Website](#)

Certificate no. (cULus) E316369

Dimensions and weights

Length	1 m	Length (inches)	39.3701 inch
Net weight	54 g		

Temperatures

Storage temperature	-20 °C...60 °C	Operating temperature	-20 °C...60 °C
Installation temperature	0 °C...50 °C		

Environmental Product Compliance

RoHS Compliance Status Compliant without exemption

REACH SVHC No SVHC above 0.1 wt%

Electrical properties

Current-carrying capacity at 50 °C	1 A	PoE / PoE+	conforming to IEEE 802.3at
------------------------------------	-----	------------	----------------------------

General standards

Connector standard	IEC 60603-7-51	Application-specific communication cable facilities	ANSI / TIA / EIA-568-B.2-10, ISO / IEC 11801:2002, EN50173-1:2007
Certificate no. (cULus)	E316369		

Standards

Connector standard	IEC 60603-7-51
--------------------	----------------

Cable structure

Strands	7	Sheathing colour	grey
Cross-section	4*2*AWG 27/7 - 4*2*0.1 mm ²	Shielding	S/FTP
Number of wires	8	Insulation cross-section	1.04 mm
Insulation	PE	Sheath diameter, max.	5.9 mm
Sheath diameter, min.	5.5 mm	Material sheath	LSZH
Wire pair shielding	Aluminium foil	Arrangement of wire cores	Twisted pair
Complete shielding	Shielding braid made from copper wiring	Overlap of shielding braid	60 %
Colour sequence or wires - wire pairs	white - blue, white - orange, white - green, white - brown		

IE-C6FP8LD0010M40W40-D

Weidmüller Interface GmbH & Co. KG

Klingenbergstraße 26

D-32758 Detmold

Germany

www.weidmueller.com

Technical data

Electrical properties of cable

Transmission rate	10 Gbit/s	Category	<20 m: Cat.6A / >20 m Class EA (ISO/IEC 11801 2010)
Operating voltage	50 V DC	Coupling attenuation up to 1000 MHz	80 dB
Separating class according to EN 50174-2	d	Capacity at 1 kHz	46 nF/km
Coupling resistance at 10 MHz / m	5.00 mΩ	Test voltage: wire-wire-shield	2.5 kV / DC for 2 sec
Resistance differential	5 %	Delay skew	2.5 ns/100m
Operating voltage (UL rating)	30 V AC / 42.4 V DC	Characteristic impedance	100 ± 15 Ω at 1–100 MHz

Mechanical and material properties of cable

Colour	grey	Halogen	halogen-free, according to IEC 60754-2
Min. bending radius, once only	4 x cable diameter	Resistance to spread of flame	in accordance with IEC 60332-2-2, in accordance with IEC 60332-1-2, in accordance with IEC 60332-3-24, in accordance with UL 2556 (FT1)

Plug

Plug right	RJ45, IP20, male contact, angled 270°, plug, Plastic, shielded	Plug left	RJ45, IP20, male contact, straight, plug, Plastic, shielded
------------	--	-----------	---

Plug, left

Plug left	RJ45, IP20, male contact, straight, plug, Plastic, shielded
-----------	---

Plug, right

Plug right	RJ45, IP20, male contact, angled 270°, plug, Plastic, shielded
------------	--

Classifications

ETIM 8.0	EC002599	ETIM 9.0	EC002599
ETIM 10.0	EC002599	ECLASS 14.0	27-06-03-08
ECLASS 15.0	27-06-03-08		

IE-C6FP8LD0010M40W40-D

Weidmüller Interface GmbH & Co. KG
Klingenbergstraße 26
D-32758 Detmold
Germany

www.weidmueller.com

Drawings

Wiring

RJ45	1	white (orange)	1	RJ45
	2	orange	2	
	3	white (green)	3	
	4	blue	4	
	5	white (blue)	5	
	6	green	6	
	7	white (brown)	7	
	8	brown	8	

Dimensioned drawing



Dimensioned drawing

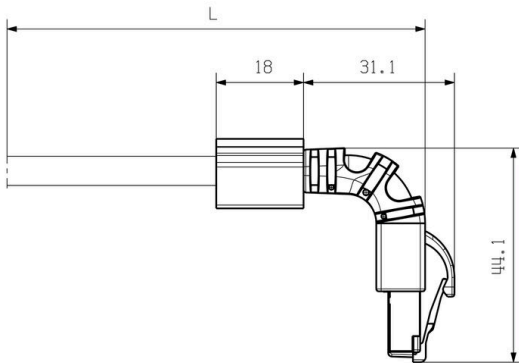

Accessories

Blank



TM-I is an acknowledged and accredited marker type for traffic engineering applications. There are various different tag lengths available for individual labelling with long character strings. Easy handling of separation and installation thanks to the project marker field. Pre-attachment of sleeves and retrofitting of tags offer excellent versatility

The special contour of TM-I allows easy assembly and secures firm positioning. They are compatible with a number of commercially available sleeves. Thanks to the MultiCard format, the tags can be printed quickly and conveniently with the PrintJet CONNECT, plotter or the STI pen.

- Easy handling of separation and installation thanks to the project marker field.
- Acknowledged and accredited marker for traffic engineering applications
- Pre-attachment of sleeves and retrofitting of tags offer excellent versatility
- Not suited for labelling with P-Ink or STI pen in connection with CLI T sleeves

For custom printing: Please send us a file of our labeling software M-Print PRO or M-Print PRO Online (without installation) for your labeling specifications.

General ordering data

Type	TM-I 12 MC NE WS	Version
Order No.	1718411044	TM-I, Insert markers, 12 x 4 mm, white
GTIN (EAN)	4008190348977	
Qty.	320 ST	
Type	TM-I 18 MC NE WS	Version
Order No.	1718431044	TM-I, Insert markers, 1.5 - 22 mm, 18 x 4 mm, white
GTIN (EAN)	4008190349011	
Qty.	320 ST	