

LXB 15.00/08/90 4.5SN BK BX

Weidmüller Interface GmbH & Co. KG
 Klingenbergstraße 26
 D-32758 Detmold
 Germany

www.weidmueller.com

Product image



Fitted with flange for accommodating forces and fixing to PCB. 101 A, 1000 V and 25 mm² conductor cross-section are possible with this PCB terminal. Proven clamping yoke connection at 15.00 mm pitch, conductor outlet direction 90°, test point.

General ordering data

Version	Printed circuit board terminals, 15.00 mm, Number of poles: 8, 90°, Solder pin length (l): 4.5 mm, tinned, black, Clamping yoke connection, Clamping range, max. : 25 mm ² , Box
Order No.	1226580000
Type	LXB 15.00/08/90 4.5SN BK BX
GTIN (EAN)	4050118011357
Qty.	10 items
Product data	IEC: 1000 V / 101 A / 1.5 - 25 mm ² UL: 600 V / 85 A / AWG 16 - AWG 4
Packaging	Box

LXB 15.00/08/90 4.5SN BK BX

Weidmüller Interface GmbH & Co. KG
Klingenbergstraße 26
D-32758 Detmold
Germany

www.weidmueller.com

Technical data

Approvals

Approvals



ROHS	Conform
UL File Number Search	UL Website
Certificate No. (UR)	E60693

Dimensions and weights

Depth	29.1 mm	Depth (inches)	1.1457 inch
Height	41.5 mm	Height (inches)	1.6339 inch
Height of lowest version	37 mm	Width	150 mm
Width (inches)	5.9055 inch	Net weight	124.7 g

Environmental Product Compliance

RoHS Compliance Status	Compliant without exemption
REACH SVHC	No SVHC above 0.1 wt%

System parameters

Product family	OMNIMATE Power - series LX	Wire connection method	Clamping yoke connection
Mounting onto the PCB	THT solder connection	Conductor outlet direction	90°
Pitch in mm (P)	15.00 mm	Pitch in inches (P)	0.591 "
Number of poles	8	Pin series quantity	1
Fitted by customer	No	Number of rows	1
Max. adjacent poles per row	10	Solder pin length (l)	4.5 mm
Solder pin dimensions	1.2 x 1.2 mm	Solder eyelet hole diameter (D)	1.6 mm
Solder eyelet hole diameter tolerance (D)+	0,1 mm	Number of solder pins per pole	4
Screwdriver blade	1.0 x 5.5	Screwdriver blade standard	DIN 5264
Tightening torque, min.	2.4 Nm	Tightening torque, max.	4 Nm
Clamping screw	M 5	Stripping length	16 mm
L1 in mm	105.00 mm	L1 in inches	4.134 "
Touch-safe protection acc. to DIN VDE 0470	IP 10	Touch-safe protection acc. to DIN VDE 57 106	Safe from finger touch
Protection degree	IP20	Volume resistance	0.50 mΩ

Material data

Insulating material	Wemid (PA)	Colour	black
Colour chart (similar)	RAL 9011	Insulating material group	I
Comparative Tracking Index (CTI)	≥ 600	Moisture Level (MSL)	
UL 94 flammability rating	V-0	Contact material	Cu-alloy
Contact surface	tinned	Layer structure of solder connection	1.5...3 μm Ni / 4...6 μm Sn matt
Storage temperature, min.	-40 °C	Storage temperature, max.	70 °C
Operating temperature, min.	-50 °C	Operating temperature, max.	120 °C
Temperature range, installation, min.	-25 °C	Temperature range, installation, max.	120 °C

Conductors suitable for connection

Clamping range, min.	1.31 mm ²
Clamping range, max.	25 mm ²

LXB 15.00/08/90 4.5SN BK BX

Weidmüller Interface GmbH & Co. KG
 Klingenbergstraße 26
 D-32758 Detmold
 Germany

www.weidmueller.com

Technical data

Wire connection cross section AWG, min.	AWG 16				
Wire connection cross section AWG, max.	AWG 4				
Solid, min. H05(07) V-U	1.5 mm ²				
Solid, max. H05(07) V-U	16 mm ²				
Stranded, min. H07V-R	6 mm ²				
Stranded, max. H07V-R	25 mm ²				
Flexible, min. H05(07) V-K	1.5 mm ²				
Flexible, max. H05(07) V-K	25 mm ²				
w. plastic collar ferrule, DIN 46228 pt 4, min.	1.5 mm ²				
w. plastic collar ferrule, DIN 46228 pt 4, max.	16 mm ²				
w. wire end ferrule, DIN 46228 pt 1, min.	1.5 mm ²				
w. wire end ferrule, DIN 46228 pt 1, max.	16 mm ²				
Plug gauge in accordance with EN 60999 a x b; ø	6.9 mm x 6.9 mm				
Clampable conductor	Cross-section for conductor connection	Type	fine-wired		
		nominal	4 mm ²		
	wire end ferrule	Stripping length	nominal	15 mm	
		Recommended wire-end ferrule	H4.0/15		
	Cross-section for conductor connection	Type	fine-wired		
		nominal	6 mm ²		
	wire end ferrule	Stripping length	nominal	15 mm	
		Recommended wire-end ferrule	H6.0/15		
	Cross-section for conductor connection	Type	fine-wired		
		nominal	10 mm ²		
	wire end ferrule	Stripping length	nominal	15 mm	
		Recommended wire-end ferrule	H10.0/15		
	Cross-section for conductor connection	Type	fine-wired		
		nominal	16 mm ²		
	wire end ferrule	Stripping length	nominal	15 mm	
		Recommended wire-end ferrule	H16.0/15		

Reference text Length of ferrules is to be chosen depending on the product and the rated voltage., The outside diameter of the plastic collar should not be larger than the pitch (P)

Rated data acc. to IEC

tested acc. to standard	IEC 60664-1, IEC 61984	Rated current, min. number of poles (Tu=20°C)	101 A
Rated current, max. number of poles (Tu=20°C)	101 A	Rated current, min. number of poles (Tu=40°C)	101 A
Rated current, max. number of poles (Tu=40°C)	101 A	Rated voltage for surge voltage class / pollution degree II/2	1000 V
Rated voltage for surge voltage class / pollution degree III/2	1000 V	Rated voltage for surge voltage class / pollution degree III/3	1000 V
Rated impulse voltage for surge voltage class/ pollution degree II/2	6 kV	Rated impulse voltage for surge voltage class/ pollution degree III/2	8 kV
Rated impulse voltage for surge voltage class/ contamination degree III/3	8 kV	Short-time withstand current resistance	3 x 1 s mit 1000 A

LXB 15.00/08/90 4.5SN BK BX

Weidmüller Interface GmbH & Co. KG
 Klingenbergstraße 26
 D-32758 Detmold
 Germany

www.weidmueller.com

Technical data

Rated data acc. to CSA

Rated voltage (Use group B / CSA)	600 V	Rated voltage (Use group C / CSA)	600 V
Rated voltage (Use group D / CSA)	600 V	Rated current (Use group B / CSA)	85 A
Rated current (Use group C / CSA)	85 A	Rated current (Use group D / CSA)	5 A
Wire cross-section, AWG, min.	AWG 16	Wire cross-section, AWG, max.	AWG 4

Rated data acc. to UL 1059

Institute (UR)	UR	Certificate No. (UR)	E60693
Rated voltage (Use group B / UL 1059)	600 V	Rated voltage (Use group C / UL 1059)	600 V
Rated voltage (Use group D / UL 1059)	600 V	Rated current (Use group B / UL 1059)	85 A
Rated current (Use group C / UL 1059)	85 A	Rated current (Use group D / UL 1059)	5 A
Wire cross-section, AWG, min.	AWG 16	Wire cross-section, AWG, max.	AWG 4
Reference to approval values	Specifications are maximum values, details - see approval certificate.		

Packing

Packaging	Box	VPE length	306.00 mm
VPE width	95.00 mm	VPE height	84.00 mm

Type tests

Test: Durability of markings	Standard	DIN EN 61984 section 7.3.2 / 09.02 taking pattern from DIN EN 60068-2-70 / 07.96		
	Test	mark of origin, type identification, pitch, approval marking CSA, approval marking UL, type of material, durability		
	Evaluation	available		
Test: Clampable cross section	Standard	DIN EN 60999 section 6 and 8.1 / 04.94, DIN EN 60947-1 section 8.2.4.5.1 / 12.99		
	Conductor type	Type of conductor and conductor cross-section	solid 1.5 mm ²	
		Type of conductor and conductor cross-section	stranded 1.5 mm ²	
		Type of conductor and conductor cross-section	solid 16 mm ²	
		Type of conductor and conductor cross-section	stranded 25 mm ²	
		Type of conductor and conductor cross-section	AWG 16/1	
		Type of conductor and conductor cross-section	AWG 16/ stranded	
		Type of conductor and conductor cross-section	AWG 4/1	
		Type of conductor and conductor cross-section	AWG 4/ stranded	
Evaluation	passed			
Test for damage to and accidental loosening of conductors	Standard	DIN EN 60999 section 8.4 / 04.94		
	Requirement	0.4 kg		

LXB 15.00/08/90 4.5SN BK BX

Weidmüller Interface GmbH & Co. KG
 Klingenbergstraße 26
 D-32758 Detmold
 Germany

www.weidmueller.com

Technical data

	Conductor type	Type of conductor and conductor cross-section	solid 1.5 mm ²	
		Type of conductor and conductor cross-section	stranded 1.5 mm ²	
		Type of conductor and conductor cross-section	AWG 16/7	
		Type of conductor and conductor cross-section	AWG 16/19	
	Evaluation	passed		
	Requirement	4,5 kg		
	Pull-out test	Conductor type	Type of conductor and conductor cross-section	AWG 4/ stranded
			Evaluation	passed
			Standard	DIN EN 60999 section 8.5 / 04.94
			Requirement	≥40 N
	Conductor type	Type of conductor and conductor cross-section	H05V-U1.5	
		Type of conductor and conductor cross-section	H05V-K1.5	
		Type of conductor and conductor cross-section	AWG 16/7	
		Type of conductor and conductor cross-section	AWG 16/19	
	Evaluation	passed		
	Requirement	≥ 135 N		
		Conductor type	Type of conductor and conductor cross-section	H05V-R25
			Type of conductor and conductor cross-section	H05V-K25
			Type of conductor and conductor cross-section	AWG 4/ stranded
			Evaluation	passed

Important note

IPC conformity Conformity: The products are developed, manufactured and delivered according international recognized standards and norms and comply with the assured properties in the data sheet resp. fulfill decorative properties in accordance with IPC-A-610 "Class 2". Further claims on the products can be evaluated on request.

- Notes**
- Additional variants on request
 - Rated current related to rated cross-section & min. No. of poles.
 - Wire end ferrule without plastic collar to DIN 46228/1
 - Wire end ferrule with plastic collar to DIN 46228/4
 - P on drawing = pitch
 - Rated data refer only to the component itself. Clearance and creepage distances to other components are to be designed in accordance with the relevant application standards.
 - The test point can only be used as potential-pickup point.
 - Long term storage of the product with average temperature of 50 °C and maximum humidity 70%, 36 months

Technical data

Classifications

ETIM 8.0	EC002643	ETIM 9.0	EC002643
ETIM 10.0	EC002643	ECLASS 14.0	27-46-01-01
ECLASS 15.0	27-46-01-01		

LXB 15.00/08/90 4.5SN BK BX

Weidmüller Interface GmbH & Co. KG
 Klingenbergstraße 26
 D-32758 Detmold
 Germany

Drawings

www.weidmueller.com

Product image



Dimensional drawing

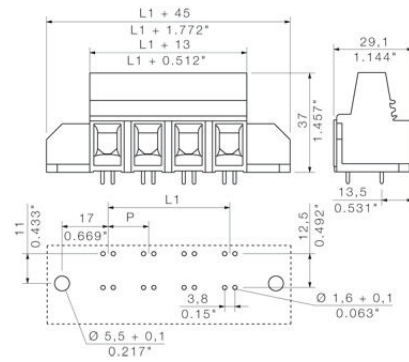

Graph



Graph

