

LUP 10.16/05/90 3.2SN BK BX

Weidmüller Interface GmbH & Co. KG
 Klingenbergstraße 26
 D-32758 Detmold
 Germany

www.weidmueller.com

Product image

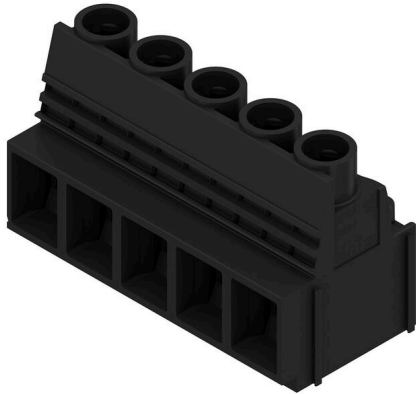

This PCB terminal provides connections for 1000 V, test point, 76 A and 16 mm² conductor cross-section with proven clamping yoke connection at 10.16 mm pitch, conductor outlet direction in 90° design.

General ordering data

Version	Printed circuit board terminals, 10.16 mm, Number of poles: 5, 90°, Solder pin length (l): 3.2 mm, tinned, black, Clamping yoke connection, Clamping range, max. : 16 mm ² , Box
Order No.	1226320000
Type	LUP 10.16/05/90 3.2SN BK BX
GTIN (EAN)	4050118010862
Qty.	20 items
Product data	IEC: 1000 V / 76 A / 0.5 - 16 mm ² UL: 300 V / 58 A / AWG 26 - AWG 6
Packaging	Box

LUP 10.16/05/90 3.2SN BK BX

Weidmüller Interface GmbH & Co. KG
Klingenbergstraße 26
D-32758 Detmold
Germany

www.weidmueller.com

Technical data

Approvals

Approvals



ROHS	Conform
UL File Number Search	UL Website
Certificate No. (cURus)	E60693

Dimensions and weights

Depth	25.1 mm	Depth (inches)	0.9882 inch
Height	34.7 mm	Height (inches)	1.3661 inch
Height of lowest version	31.5 mm	Width	51.6 mm
Width (inches)	2.0315 inch	Net weight	46.16 g

Environmental Product Compliance

RoHS Compliance Status	Compliant without exemption
REACH SVHC	No SVHC above 0.1 wt%

System parameters

Product family	OMNIMATE Power - series LUP	Wire connection method	Clamping yoke connection
Mounting onto the PCB	THT solder connection	Conductor outlet direction	90°
Pitch in mm (P)	10.16 mm	Pitch in inches (P)	0.400 "
Number of poles	5	Pin series quantity	1
Fitted by customer	Yes	Number of rows	1
Max. adjacent poles per row	12	Solder pin length (l)	3.2 mm
Solder pin dimensions	1.2 x 1.2 mm	Solder eyelet hole diameter (D)	1.6 mm
Solder eyelet hole diameter tolerance (D)+	0,1 mm	Number of solder pins per pole	2
Screwdriver blade	1.0 x 5.5, PZ 2	Screwdriver blade standard	DIN 5264
Tightening torque, min.	1.2 Nm	Tightening torque, max.	1.5 Nm
Clamping screw	M 4	Stripping length	12 mm
L1 in mm	40.64 mm	L1 in inches	1.600 "
Touch-safe protection acc. to DIN VDE 0470	IP20 plugged/ IP10 unplugged	Touch-safe protection acc. to DIN VDE 57 106	Safe from finger touch
Protection degree	IP20	Volume resistance	0.50 mΩ

Material data

Insulating material	Wemid (PA)	Colour	black
Colour chart (similar)	RAL 9011	Insulating material group	I
Comparative Tracking Index (CTI)	≥ 600	Moisture Level (MSL)	
UL 94 flammability rating	V-0	Contact material	Cu-alloy
Contact surface	tinned	Layer structure of solder connection	1.5...3 μm Ni / 4...6 μm Sn matt
Storage temperature, min.	-40 °C	Storage temperature, max.	70 °C
Operating temperature, min.	-50 °C	Operating temperature, max.	120 °C
Temperature range, installation, min.	-25 °C	Temperature range, installation, max.	120 °C

Conductors suitable for connection

Clamping range, min.	0.13 mm ²
Clamping range, max.	16 mm ²

LUP 10.16/05/90 3.2SN BK BX

Weidmüller Interface GmbH & Co. KG
 Klingenbergstraße 26
 D-32758 Detmold
 Germany

www.weidmueller.com

Technical data

Wire connection cross section AWG, min.	AWG 22			
Wire connection cross section AWG, max.	AWG 6			
Solid, min. H05(07) V-U	0.5 mm ²			
Solid, max. H05(07) V-U	16 mm ²			
Stranded, min. H07V-R	6 mm ²			
Stranded, max. H07V-R	16 mm ²			
Flexible, min. H05(07) V-K	0.5 mm ²			
Flexible, max. H05(07) V-K	16 mm ²			
w. plastic collar ferrule, DIN 46228 pt 4, min.	2.5 mm ²			
w. plastic collar ferrule, DIN 46228 pt 4, max.	10 mm ²			
w. wire end ferrule, DIN 46228 pt 1, min.	2.5 mm ²			
w. wire end ferrule, DIN 46228 pt 1, max.	10 mm ²			
Plug gauge in accordance with EN 60999 a x b; ø	5.4 mm x 5.1 mm; 5.3 mm			
Clampable conductor	Cross-section for conductor connection	Type	fine-wired	
		nominal	2.5 mm ²	
	wire end ferrule	Stripping length	nominal	12 mm
		Recommended wire-end ferrule	H2.5/12	
		Stripping length	nominal	14 mm
		Recommended wire-end ferrule	H2.5/19D BL	
	Cross-section for conductor connection	Type	fine-wired	
		nominal	4 mm ²	
	wire end ferrule	Stripping length	nominal	12 mm
		Recommended wire-end ferrule	H4.0/12	
		Stripping length	nominal	14 mm
		Recommended wire-end ferrule	H4.0/20D GR	
	Cross-section for conductor connection	Type	fine-wired	
		nominal	6 mm ²	
	wire end ferrule	Stripping length	nominal	12 mm
		Recommended wire-end ferrule	H6.0/12	
		Stripping length	nominal	14 mm
		Recommended wire-end ferrule	H6.0/20 SW	
	Cross-section for conductor connection	Type	fine-wired	
		nominal	10 mm ²	
wire end ferrule	Stripping length	nominal	15 mm	
	Recommended wire-end ferrule	H10.0/22 EB		
	Stripping length	nominal	12 mm	
	Recommended wire-end ferrule	H10.0/12		

Reference text Length of ferrules is to be chosen depending on the product and the rated voltage., The outside diameter of the plastic collar should not be larger than the pitch (P)

Rated data acc. to IEC

tested acc. to standard	IEC 60664-1, IEC 61984	Rated current, min. number of poles (Tu=20°C)	76 A
Rated current, max. number of poles (Tu=20°C)	72 A	Rated current, min. number of poles (Tu=40°C)	72 A

LUP 10.16/05/90 3.2SN BK BX

Weidmüller Interface GmbH & Co. KG

Klingenbergstraße 26
D-32758 Detmold
Germany

www.weidmueller.com

Technical data

Rated current, max. number of poles (Tu=40°C)	62 A	Rated voltage for surge voltage class / pollution degree II/2	1000 V
Rated voltage for surge voltage class / pollution degree III/2	1000 V	Rated voltage for surge voltage class / pollution degree III/3	800 V
Rated impulse voltage for surge voltage class/ pollution degree II/2	6 kV	Rated impulse voltage for surge voltage class/ pollution degree III/2	8 kV
Rated impulse voltage for surge voltage class/ contamination degree III/3	8 kV	Short-time withstand current resistance	1 x 1s with 700 A

Rated data acc. to CSA

Institute (CSA)	CSA	Certificate No. (CSA)	200039-1198743
Rated voltage (Use group B / CSA)	300 V	Rated voltage (Use group C / CSA)	300 V
Rated voltage (Use group D / CSA)	600 V	Rated current (Use group B / CSA)	58 A
Rated current (Use group C / CSA)	58 A	Rated current (Use group D / CSA)	5 A
Wire cross-section, AWG, min.	AWG 22	Wire cross-section, AWG, max.	AWG 6
Reference to approval values	Specifications are maximum values, details - see approval certificate.		

Rated data acc. to UL 1059

Institute (cURus)	CURUS	Certificate No. (cURus)	E60693
Rated voltage (Use group B / UL 1059)	300 V	Rated voltage (Use group C / UL 1059)	300 V
Rated voltage (Use group D / UL 1059)	600 V	Rated current (Use group B / UL 1059)	58 A
Rated current (Use group C / UL 1059)	58 A	Rated current (Use group D / UL 1059)	5 A
Wire cross-section, AWG, min.	AWG 26	Wire cross-section, AWG, max.	AWG 6
Reference to approval values	Specifications are maximum values, details - see approval certificate.		

Packing

Packaging	Box	VPE length	229.00 mm
VPE width	138.00 mm	VPE height	47.00 mm

Type tests

Test: Durability of markings	Standard	DIN EN 61984 section 7.3.2 / 09.02 taking pattern from DIN EN 60068-2-70 / 07.96	
	Test	mark of origin, type identification, type of material, approval marking UL, durability	
	Evaluation	available	
	Standard	DIN EN 61984 section 7.3.2 / 09.02 taking pattern from DIN EN 60068-2-70 / 07.96	
Test: Clampable cross section	Standard	DIN EN 60999-1 section 7 and 9.1 / 12.00, DIN EN 60947-1 section 8.2.4.5.1 / 12.02	
	Conductor type	Type of conductor and conductor cross-section	solid 0.5 mm ²
		Type of conductor and conductor cross-section	stranded 0.5 mm ²
		Type of conductor and conductor cross-section	solid 16 mm ²
		Type of conductor and conductor cross-section	stranded 16 mm ²

LUP 10.16/05/90 3.2SN BK BX

Weidmüller Interface GmbH & Co. KG
 Klingenbergstraße 26
 D-32758 Detmold
 Germany

www.weidmueller.com

Technical data

	Type of conductor and conductor cross-section	H07V-U16
	Type of conductor and conductor cross-section	AWG 6/7
Evaluation	passed	

Important note

IPC conformity	Conformity: The products are developed, manufactured and delivered according international recognized standards and norms and comply with the assured properties in the data sheet resp. fulfill decorative properties in accordance with IPC-A-6 10 "Class 2". Further claims on the products can be evaluated on request.
Notes	<ul style="list-style-type: none"> • Additional variants on request • Rated current related to rated cross-section & min. No. of poles. • Wire end ferrule without plastic collar to DIN 46228/1 • Wire end ferrule with plastic collar to DIN 46228/4 • The data given under CSA relates to a cUL approval - E60693 • P on drawing = pitch • Rated data refer only to the component itself. Clearance and creepage distances to other components are to be designed in accordance with the relevant application standards. • The test point can only be used as potential-pickup point. • Long term storage of the product with average temperature of 50 °C and maximum humidity 70%, 36 months

Classifications

ETIM 8.0	EC002643	ETIM 9.0	EC002643
ETIM 10.0	EC002643	ECLASS 14.0	27-46-01-01
ECLASS 15.0	27-46-01-01		

LUP 10.16/05/90 3.2SN BK BX

Weidmüller Interface GmbH & Co. KG
 Klingenbergstraße 26
 D-32758 Detmold
 Germany

www.weidmueller.com

Drawings

Product image



Dimensional drawing

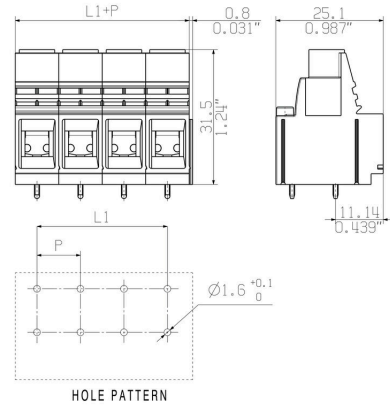

Graph



Graph

