

SU 10.16IT/04/270MF4 3.5AG BK BX

Weidmüller Interface GmbH & Co. KG
 Klingenbergstraße 26
 D-32758 Detmold
 Germany

www.weidmueller.com

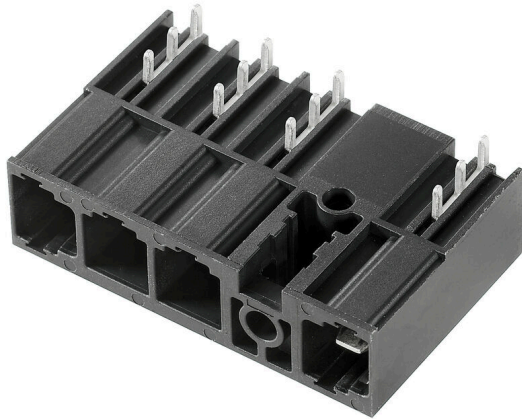

Male header with middle solder flange fastening in 10.16 pitch for 400-V IT systems according to IEC 61800-5-1. UL approval in compliance with UL840 (600 V) when using leading contact. When used together with the BUZ 10.16 IT, they comply with the expanded requirements for 5.5 mm of touch protection with IT systems (400 V relative to earth), according to IEC 61800-5-1. The middle-flange interlock feature decreases the space required by one pitch width when compared to other standard solutions. Available on request with screw flange or without flange.

General ordering data

Version	PCB plug-in connector, male header, closed side, Middle flange, THT solder connection, 10.16 mm, Number of poles: 4, 270°, Solder pin length (l): 3.5 mm, silver-plated, black, Box
Order No.	1157350000
Type	SU 10.16IT/04/270MF4 3.5AG BK BX
GTIN (EAN)	4032248944767
Qty.	36 items
Product data	IEC: 1000 V / 78.3 A UL: 300 V / 60 A
Packaging	Box

SU 10.16IT/04/270MF4 3.5AG BK BX

Weidmüller Interface GmbH & Co. KG
 Klingenbergstraße 26
 D-32758 Detmold
 Germany

www.weidmueller.com

Technical data

Approvals

Approvals



ROHS	Conform
UL File Number Search	UL Website
Certificate No. (cURus)	E60693

Dimensions and weights

Net weight	17.89 g
------------	---------

Environmental Product Compliance

RoHS Compliance Status	Compliant without exemption
REACH SVHC	No SVHC above 0.1 wt%

System specifications

Product family	OMNIMATE Power - series BU/SU 10.16IT				
Type of connection	Board connection				
Mounting onto the PCB	THT solder connection				
Pitch in mm (P)	10.16 mm				
Pitch in inches (P)	0.400 "				
Outgoing elbow	270°				
Number of poles	4				
Number of solder pins per pole	3				
Solder pin length (l)	3.5 mm				
Solder pin length tolerance	+0.1 / -0.3 mm				
Solder pin dimensions	1.2 x 1.1 mm				
Solder pin dimensions = d tolerance	+0.1 / -0.1 mm				
Solder eyelet hole diameter (D)	1.6 mm				
Solder eyelet hole diameter tolerance (D)	+ 0,1 mm				
L1 in mm	40.64 mm				
L1 in inches	1.600 "				
Number of rows	1				
Pin series quantity	1				
Touch-safe protection acc. to DIN VDE 57 106	Safe from finger touch, plugged				
Touch-safe protection acc. to DIN VDE 0470	IP20 plugged				
Volume resistance	2.00 mΩ				
Can be coded	Yes				
Tightening torque	Torque type	Mounting screw, PCB			
	Usage information	Thickness	min.	1.44 mm	
			max.	1.76 mm	
		Tightening torque	min.	0.25 Nm	
			max.	0.3 Nm	
		Recommended screw	Part number	SU 10.16 BFSC P 35X 14	
			Thickness	min.	2.88 mm
				max.	3.52 mm
		Tightening torque	min.	0.2 Nm	
			max.	0.25 Nm	

SU 10.16IT/04/270MF4 3.5AG BK BX

Weidmüller Interface GmbH & Co. KG
 Klingenbergstraße 26
 D-32758 Detmold
 Germany

www.weidmueller.com

Technical data

Recommended screw	Part number	SU 10.16 BFSC P 35X 14
Thickness	min.	1.44 mm
	max.	3.52 mm
Tightening torque	min.	0.8 Nm
	max.	0.9 Nm
Recommended screw	Part number	SU 10.16 BFSC S 35X12

Material data

Insulating material	PA GF	Colour	black
Colour chart (similar)	RAL 9011	Insulating material group	I
Comparative Tracking Index (CTI)	≥ 600	Moisture Level (MSL)	
UL 94 flammability rating	V-0	Contact material	Cu-alloy
Contact surface	silver-plated	Layer structure of solder connection	≥ 3 µm Ag
Layer structure of plug contact	≥ 3 µm Ag	Storage temperature, min.	-40 °C
Storage temperature, max.	70 °C	Operating temperature, min.	-50 °C
Operating temperature, max.	120 °C	Temperature range, installation, min.	-25 °C
Temperature range, installation, max.	120 °C		

Rated data acc. to IEC

tested acc. to standard	IEC 60664-1, IEC 61984	Rated current, min. number of poles (Tu=20°C)	78.3 A
Rated current, max. number of poles (Tu=20°C)	67.9 A	Rated current, min. number of poles (Tu=40°C)	70.6 A
Rated current, max. number of poles (Tu=40°C)	61.3 A	Rated voltage for surge voltage class / pollution degree II/2	1000 V
Rated voltage for surge voltage class / pollution degree III/2	1000 V	Rated voltage for surge voltage class / pollution degree III/3	690 V
Rated impulse voltage for surge voltage class/ pollution degree II/2	6 kV	Rated impulse voltage for surge voltage class/ pollution degree III/2	8 kV
Rated impulse voltage for surge voltage class/ contamination degree III/3	8 kV	Short-time withstand current resistance	3 x 1s mit 1000 A
Creepage distance, min.	10.5 mm	Clearance, min.	8.9 mm

Rated data acc. to CSA

Institute (CSA)	CSA	Certificate No. (CSA)	200039-1121690
Rated voltage (Use group B / CSA)	300 V	Rated voltage (Use group C / CSA)	300 V
Rated voltage (Use group D / CSA)	600 V	Rated current (Use group B / CSA)	60 A
Rated current (Use group C / CSA)	60 A	Rated current (Use group D / CSA)	5 A
Reference to approval values	Specifications are maximum values, details - see approval certificate.		

Rated data acc. to UL 1059

Institute (cURus)	CURUS	Certificate No. (cURus)	E60693
Rated voltage (Use group B / UL 1059)	300 V	Rated voltage (Use group C / UL 1059)	300 V
Rated voltage (Use group D / UL 1059)	600 V	Rated current (Use group B / UL 1059)	60 A
Rated current (Use group C / UL 1059)	60 A	Rated current (Use group D / UL 1059)	5 A
Creepage distance, min.	10.5 mm	Clearance distance, min.	8.9 mm
Reference to approval values	Specifications are maximum values, details - see approval certificate.		

SU 10.16IT/04/270MF4 3.5AG BK BX

Weidmüller Interface GmbH & Co. KG
 Klingenbergstraße 26
 D-32758 Detmold
 Germany

www.weidmueller.com

Technical data

Packing

Packaging	Box	VPE length	352.00 mm
VPE width	136.00 mm	VPE height	49.00 mm

Important note

IPC conformity	Conformity: The products are developed, manufactured and delivered according international recognized standards and norms and comply with the assured properties in the data sheet resp. fulfill decorative properties in accordance with IPC-A-610 "Class 2". Further claims on the products can be evaluated on request.
Notes	<ul style="list-style-type: none"> • Additional variants on request • Rated current related to rated cross-section & min. No. of poles. • P on drawing = pitch • Rated data refer only to the component itself. Clearance and creepage distances to other components are to be designed in accordance with the relevant application standards. • For all applications with flange we recommend to fix the pin header with the help of the soldering flange or a self-tapping screw on the board. • In accordance with IEC 61984, OMNIMATE-connectors are connectors without breaking capacity (COC). During designated use, connectors are not allowed to be engaged or disengaged when live or under load • Long term storage of the product with average temperature of 50 °C and maximum humidity 70%, 36 months

Classifications

ETIM 8.0	EC002637	ETIM 9.0	EC002637
ETIM 10.0	EC002637	ECLASS 14.0	27-46-02-01
ECLASS 15.0	27-46-02-01		

SU 10.16IT/04/270MF4 3.5AG BK BX

Weidmüller Interface GmbH & Co. KG
 Klingenbergstraße 26
 D-32758 Detmold
 Germany

www.weidmueller.com

Drawings

Product image

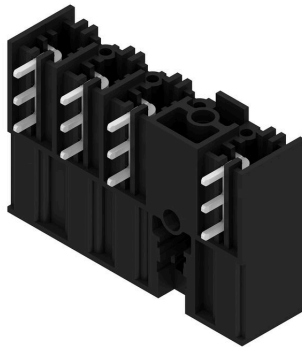

Dimensional drawing

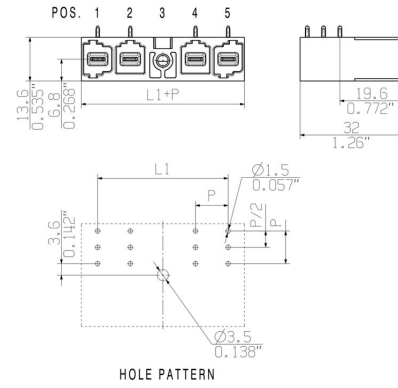

Connection diagram

6	M(S)F6	o	o	o	o	o	X	o
6	M(S)F5	o	o	o	o	X	o	o
6	M(S)F4	o	o	o	X	o	o	o
6	M(S)F3	o	o	X	o	o	o	o
6	M(S)F2	o	X	o	o	o	o	o
5	M(S)F5	o	o	o	o	X	o	
5	M(S)F4	o	o	o	X	o	o	
5	M(S)F3	o	o	X	o	o	o	
5	M(S)F2	o	X	o	o	o	o	
4	M(S)F4	o	o	o	X	o		
4	M(S)F3	o	o	X	o	o		
4	M(S)F2	o	X	o	o	o		
3	M(S)F3	o	o	X	o			
3	M(S)F2	o	X	o	o			
2	M(S)F2	o	X	o				
No of poles	X = middle flange position	1	2	3	4	5	6	7

Example of use

