

TRS 24VUC 2CO

Weidmüller Interface GmbH & Co. KG
 Klingenbergstraße 26
 D-32758 Detmold
 Germany

www.weidmueller.com

Product image

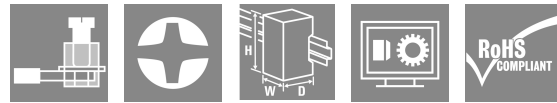
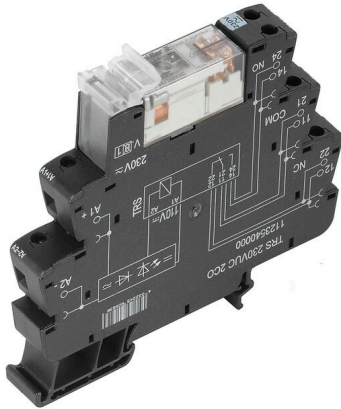

Similar to illustration

- 2 CO contacts
- Contact material: AgNi
- Unique multi-voltage input from 24 to 230 V UC
- Input voltages from 5 V DC to 230 V UC with coloured marking: AC: red, DC: blue, UC: white

General ordering data

Version	TERMSERIES, Relay module, Number of contacts: 2, CO contact AgNi, Rated control voltage: 24 V UC $\pm 10\%$, Continuous current: 8 A, Screw connection, Test button available: No
Order No.	1123500000
Type	TRS 24VUC 2CO
GTIN (EAN)	4032248905287
Qty.	10 items

TRS 24VUC 2CO

Weidmüller Interface GmbH & Co. KG

Klingenbergstraße 26
D-32758 Detmold
Germany

www.weidmueller.com

Technical data

Approvals

Approvals



ROHS Conform

UL File Number Search [UL Website](#)

Certificate no. (cULus) E141197

Dimensions and weights

Depth	87.8 mm	Depth (inches)	3.4567 inch
Height	89.6 mm	Height (inches)	3.5276 inch
Width	12.8 mm	Width (inches)	0.5039 inch
Net weight	57 g		

Temperatures

Storage temperature	-40 °C...85 °C	Ambient temperature	-40 °C...60 °C
Operating temperature		Humidity	5-95% relative humidity, Tu = 40°C, without condensation

Environmental Product Compliance

RoHS Compliance Status	Compliant with exemption
RoHS Exemption (if applicable/known)	7a, 7cl
REACH SVHC	Lead 7439-92-1
SCIP	9e2cbc49-76d9-4611-b8ec-5b4f549a0aa9

Rated data UL

Ambient temperature (operational), max.	60 °C	Connection cross-section AWG, min.	AWG 26
Connection cross-section AWG, max.	AWG 14	Type of conductor	rigid copper conductor, flexible copper conductor
Tightening torque, max.	0.4 Nm	Pollution severity level	2

Control side

Rated control voltage	24 V UC ±10 %	Rated current AC	16 mA
Rated current DC	14 mA	Power rating	390 mVA / 350 mW
Status indicator	Green LED	Protective circuit	Rectifier
Coil voltage of the replacement relay deviating from the rated control voltage	Yes	Coil voltage of the replacement relay	24 V DC

Load side

Rated switching voltage	250 V AC	Continuous current	8 A
Max. switching frequency at rated load	0.1 Hz	Max. switching voltage, AC	250 V
Max. switching voltage, DC	250 V	Inrush current	15 A / 4 s
AC switching capacity (resistive), max.	2000 VA	DC switching capacity (resistive), max.	192 W @ 24 V
Switch-on delay	≤ 11 ms	Switch-off delay	<22 ms
Contact type	2 CO contact (AgNi)	Mechanical service life	30 x 106 switching cycles
Min. switching power	1 mA @ 24 V, 10 mA @ 10 V, 100 mA @ 5 V		

TRS 24VUC 2CO

Weidmüller Interface GmbH & Co. KG

 Klingenbergstraße 26
 D-32758 Detmold
 Germany

www.weidmueller.com

Technical data

General data

Operating altitude	≤ 2000 m, above sea level		
Mounting rail	TS 35		
Test button available	No		
Mechanical switch position indicator	No		
Colour	black		
UL94 flammability rating component	Component	Housing	
	UL94 flammability rating	V-0	
	Component	Retaining clip	
	UL94 flammability rating	V-0	

Insulation coordination

Rated voltage	300 V	Pollution severity	2
Surge voltage category	III	Clearance and creepage distances for control side - load side	≥ 6 mm
Dielectric strength for control side - load side	3.51 kVeff / 1 min.	Type of isolation at input and output	reinforced insulation
Dielectric strength of neighbouring contacts	2.5 kVeff / 1 Min.	Type of isolation at neighbouring contacts	Basic insulation
Dielectric strength of open contact	1 kVeff / 1 min	Dielectric strength to mounting rail	4 kVeff / 1 Min.
Impulse withstand voltage	6 kV (1.2/50 µs)	Protection degree	IP20

Further details of approvals / standards

Certificate No. (DNV)	TAA00001E5	Certificate no. (cULus)	E141197
-----------------------	------------	-------------------------	---------

Connection data

Wire connection method	Screw connection	Stripping length, rated connection	8 mm
Tightening torque, max.	0.4 Nm	Clamping range, rated connection	1.5 mm ²
Clamping range, min.	0.14 mm ²	Clamping range, max.	2.5 mm ²
Wire connection cross section AWG, min.	AWG 26	Wire connection cross section AWG, max.	AWG 14
Wire cross-section, solid, min.	0.14 mm ²	Wire cross-section, solid, max.	2.5 mm ²
Wire cross-section, solid, min. (AWG)	AWG 26	Wire cross-section, solid, max. (AWG)	AWG 14
Wire connection cross section, finely stranded, min.	0.14 mm ²	Wire connection cross section, finely stranded, max.	2.5 mm ²
Wire cross-section, finely stranded, min. (AWG)	AWG 26	Wire cross-section, finely stranded, max. (AWG)	AWG 16
Wire connection cross-section, finely stranded with wire-end ferrules DIN 46228/4, min.	0.25 mm ²	Wire connection cross-section, finely stranded with wire-end ferrules DIN 46228/4, max.	2.5 mm ²
Conductor cross-section, flexible, AEH (DIN 46228-1), min.	0.25 mm ²	Conductor cross-section, flexible, AEH (DIN 46228-1), max.	1.5 mm ²
Wire connection cross section, finely stranded, two clampable wires, min.	0.5 mm ²	Wire cross-section, finely stranded, two clampable wires, max.	1 mm ²
Blade size	size PH0		

Classifications

ETIM 8.0	EC001437	ETIM 9.0	EC001437
ETIM 10.0	EC001437	ECLASS 14.0	27-37-16-01
ECLASS 15.0	27-37-16-01		

Drawings

Wiring diagram

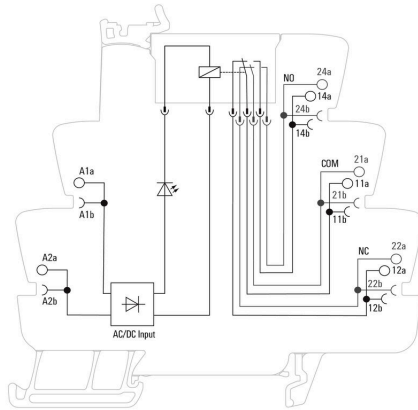

Graph

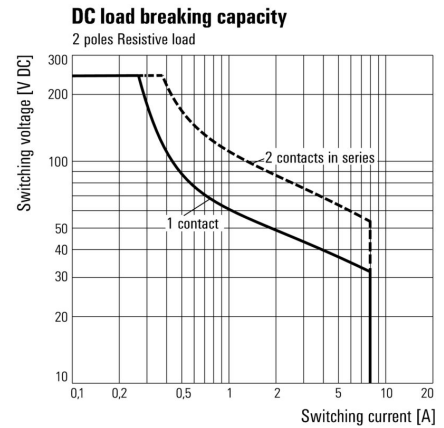

DC load limit curve Resistive load

Graph

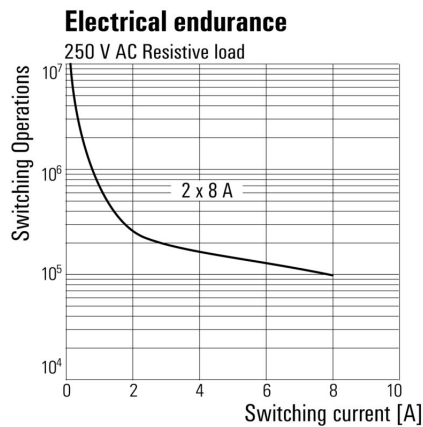

Electrical service life 230 V AC resistive load 230 V AC resistive load

Dimensional drawing

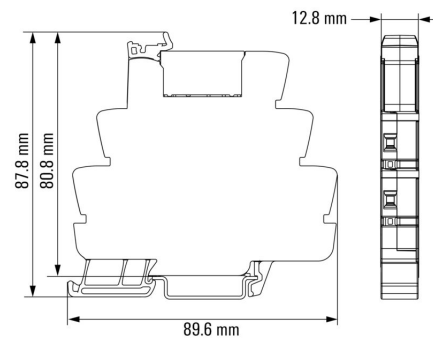

Miscellaneous

Type code TERMSERIES electromechanical relay versions

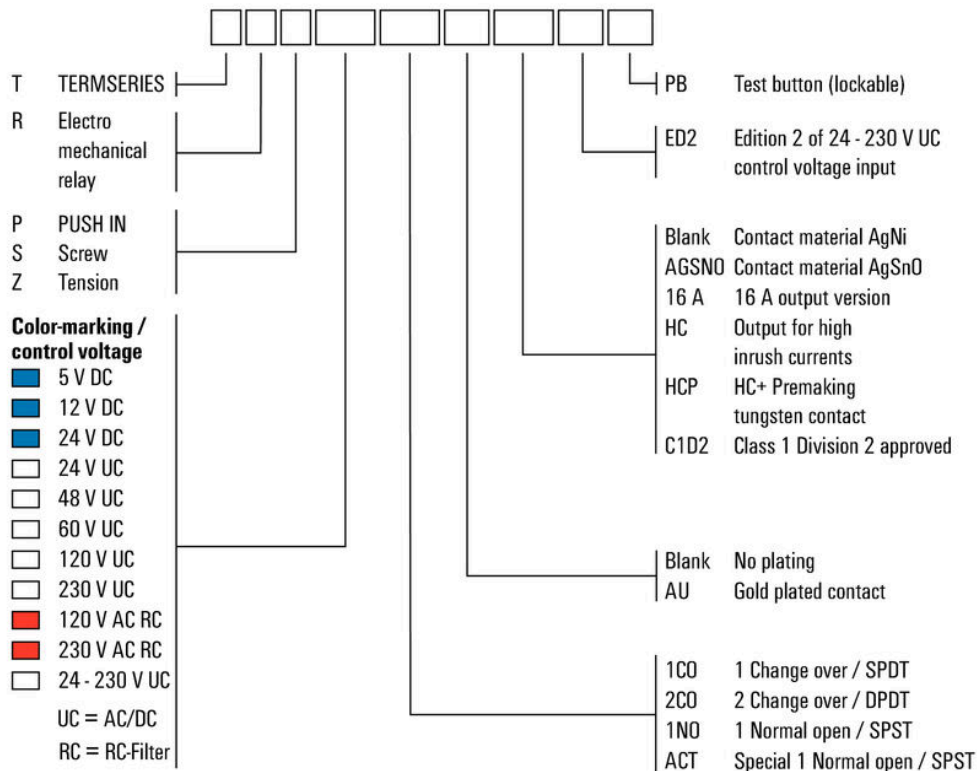

Type codes