

BLL 7.62HP/04/180 3.2SN BK BX

Weidmüller Interface GmbH & Co. KG
 Klingenbergstraße 26
 D-32758 Detmold
 Germany

www.weidmueller.com

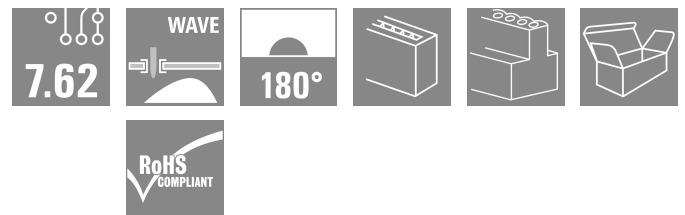
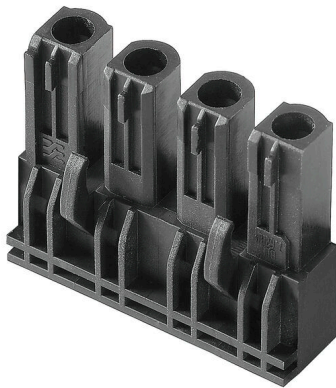

180° female header for the PCB with a pitch of 7.62.
 Meets IEC 61800-5-1 requirements and enables UL approval as per UL840 600 V. Ideal touch-safe solution for the power output and intermediate circuit applications.
 The mating profile guarantees touch safety of >3 mm as per IEC61800-5-1.
 Variants: without flange, with screw flange or with soldered flange.

General ordering data

Version	PCB plug-in connector, female header, closed side, THT solder connection, 7.62 mm, Number of poles: 4, 180°, Solder pin length (l): 3.2 mm, tinned, black, Box
Order No.	1122090000
Type	BLL 7.62HP/04/180 3.2SN BK BX
GTIN (EAN)	4032248903153
Qty.	60 items
Product data	IEC: 630 V / 24 A UL: 300 V / 20 A
Packaging	Box
Delivery status	This article will no longer be available in the future.
Last order date	2027-11-30T00:00:00+01:00
Creation date	18.05.2026 10:10:32 MEZ

BLL 7.62HP/04/180 3.2SN BK BX

Weidmüller Interface GmbH & Co. KG
Klingenbergstraße 26
D-32758 Detmold
Germany

www.weidmueller.com

Technical data

Approvals

Approvals



ROHS Conform
UL File Number Search [UL Website](#)
Certificate No. (cURus) E60693

Dimensions and weights

Depth	10.4 mm	Depth (inches)	0.4094 inch
Height	27.7 mm	Height (inches)	1.0905 inch
Width	29.66 mm	Width (inches)	1.1677 inch
Net weight	5.46 g		

Environmental Product Compliance

RoHS Compliance Status Compliant without exemption
REACH SVHC No SVHC above 0.1 wt%

System Parameters

Product family	OMNIMATE Power - series BL/SL 7.62HP	Type of connection	Board connection
Pitch in mm (P)	7.62 mm	Pitch in inches (P)	0.300 "
Number of poles	4	L1 in mm	22.86 mm
L1 in inches	0.900 "	Number of rows	1
Pin series quantity	1	Touch-safe protection acc. to DIN VDE 57 106	Safe from finger touch
Touch-safe protection acc. to DIN VDE 0470	IP 20	Can be coded	Yes
Plugging force/pole, max.	10 N	Pulling force/pole, max.	7 N

Material data

Insulating material	PA GF	Colour	black
Colour chart (similar)	RAL 9011	Insulating material group	IIIa
Comparative Tracking Index (CTI)	≥ 200	Moisture Level (MSL)	
UL 94 flammability rating	V-0	Contact material	Cu-alloy
Contact surface	tinned	Layer structure of solder connection	2...3 µm Ni / 2...4 µm Sn matt
Layer structure of plug contact	4...8 µm Sn hot-dip tinned	Storage temperature, min.	-40 °C
Storage temperature, max.	70 °C	Operating temperature, min.	-50 °C
Operating temperature, max.	100 °C	Temperature range, installation, min.	-25 °C
Temperature range, installation, max.	100 °C		

Rated data acc. to IEC

tested acc. to standard	IEC 60664-1, IEC 61984	Rated current, min. number of poles (Tu=20°C)	24 A
Rated current, max. number of poles (Tu=20°C)	24 A	Rated current, min. number of poles (Tu=40°C)	24 A
Rated current, max. number of poles (Tu=40°C)	21 A	Rated voltage for surge voltage class / pollution degree II/2	630 V
Rated voltage for surge voltage class / pollution degree III/2	630 V	Rated voltage for surge voltage class / pollution degree III/3	400 V

BLL 7.62HP/04/180 3.2SN BK BX

Weidmüller Interface GmbH & Co. KG
 Klingenbergstraße 26
 D-32758 Detmold
 Germany

www.weidmueller.com

Technical data

Rated impulse voltage for surge voltage class/ pollution degree II/2	4 kV	Rated impulse voltage for surge voltage class/ pollution degree III/2	6 kV
Rated impulse voltage for surge voltage class/ contamination degree III/3	6 kV	Short-time withstand current resistance	3 x 1s with 180 A
Creepage distance, min.	7.8 mm	Clearance, min.	7.2 mm

Rated data acc. to CSA

Rated voltage (Use group B / CSA)	300 V	Rated voltage (Use group C / CSA)	150 V
Rated voltage (Use group D / CSA)	300 V	Rated current (Use group B / CSA)	20 A
Rated current (Use group C / CSA)	20 A	Rated current (Use group D / CSA)	10 A

Rated data acc. to UL 1059

Institute (cURus)	CURUS	Certificate No. (cURus)	E60693
Rated voltage (Use group B / UL 1059)	300 V	Rated voltage (Use group C / UL 1059)	150 V
Rated voltage (Use group D / UL 1059)	300 V	Rated current (Use group B / UL 1059)	20 A
Rated current (Use group C / UL 1059)	20 A	Rated current (Use group D / UL 1059)	10 A
Creepage distance, min.	7.8 mm	Clearance distance, min.	7.2 mm
Reference to approval values	Specifications are maximum values, details - see approval certificate.		

Packing

Packaging	Box	VPE length	350.00 mm
VPE width	140.00 mm	VPE height	33.00 mm

Important note

IPC conformity	Conformity: The products are developed, manufactured and delivered according international recognized standards and norms and comply with the assured properties in the data sheet resp. fulfill decorative properties in accordance with IPC-A-6 10 "Class 2". Further claims on the products can be evaluated on request.
Notes	<ul style="list-style-type: none"> • Additional variants on request • Gold-plated contact surfaces on request • Spacing between rows: see hole layout • Rated current related to rated cross-section & min. No. of poles. • P on drawing = pitch • Rated data refer only to the component itself. Clearance and creepage distances to other components are to be designed in accordance with the relevant application standards. • In accordance with IEC 61984, OMNIMATE-connectors are connectors without breaking capacity (COC). During designated use, connectors are not allowed to be engaged or disengaged when live or under load • Long term storage of the product with average temperature of 50 °C and maximum humidity 70%, 36 months

Classifications

ETIM 8.0	EC002637	ETIM 9.0	EC002637
ETIM 10.0	EC002637	ECLASS 14.0	27-46-02-01
ECLASS 15.0	27-46-02-01		

BLL 7.62HP/04/180 3.2SN BK BX

Weidmüller Interface GmbH & Co. KG
 Klingenbergstraße 26
 D-32758 Detmold
 Germany

www.weidmueller.com

Drawings

Product image

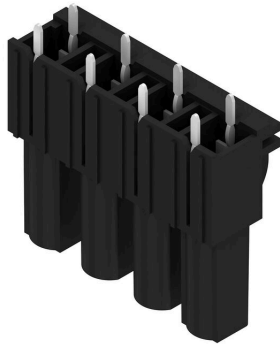

Dimensional drawing

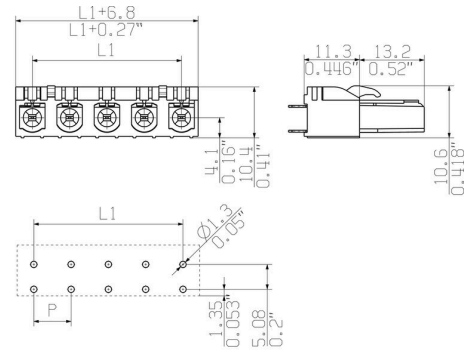

Graph

BLL 7.62HP/./90 - SLZ 7.62HP/./180



Graph

BLL 7.62HP/./90 - SLF 7.62HP/./180



Graph

BLL 7.62HP/./90 - SLZ 7.62HP/./180



BLL 7.62HP/04/180 3.2SN BK BX

Weidmüller Interface GmbH & Co. KG
 Klingenbergstraße 26
 D-32758 Detmold
 Germany

www.weidmueller.com

Accessories

Coding elements



Only connects what is supposed to be connected: the right connection at the right place.
 Coding elements and locking devices clearly assign connecting elements during the manufacturing process and operation
 The coding elements and locking devices are inserted prior to assembly or during the cable assembly phase. The Weidmüller alternative: configure online using the variant configurator to precode prior to delivery. Incorrect assembly on the circuit board and incorrect plugging of connecting elements is no longer possible. The advantage: no troubleshooting during manufacture and no operational errors by the user.

General ordering data

Type	BLZ/SL KO OR BX	Version
Order No.	1573010000	PCB plug-in connector, Accessories, Coding element, orange, Number
GTIN (EAN)	4008190048396	of poles: 1
Qty.	100 ST	
Type	BLZ/SL KO BK BX	Version
Order No.	1545710000	PCB plug-in connector, Accessories, Coding element, black, Number
GTIN (EAN)	4008190087142	of poles: 1
Qty.	50 ST	

BLL 7.62HP/04/180 3.2SN BK BX

Weidmüller Interface GmbH & Co. KG
Klingenbergstraße 26
D-32758 Detmold
Germany

Counterpart

www.weidmueller.com

SLF 7.62HP/180FSH

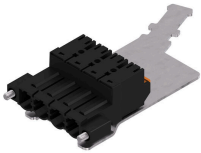

180° inverted male header with PUSH-IN connection technology for field wiring in 2.5 mm² with a 7.62 pitch. Also ideal as a touch-safe solution for inverse voltages. Meets the requirements of UL1059 600 V class C and IEC 61800-5-1.

Variants: available without flange, with external flange, with release latch. Including pre-assembled pluggable shield connection for large area shielding in your application.

General ordering data

Type	SLF 7.62HP/04/180FSH180...	Version
Order No.	2614140000	PCB plug-in connector, male plug, 7.62 mm, Number of poles: 4,
GTIN (EAN)	4050118618044	180°, PUSH IN with actuator, Tension-clamp connection, Clamping
Qty.	40 ST	range, max. : 2.5 mm ² , Box
Type	SLF 7.62HP/04/180FSH160...	Version
Order No.	2632730000	PCB plug-in connector, male plug, 7.62 mm, Number of poles: 4,
GTIN (EAN)	4050118647020	180°, PUSH IN with actuator, Tension-clamp connection, Clamping
Qty.	40 ST	range, max. : 2.5 mm ² , Box
Type	SLF 7.62HP/04/180FSH200...	Version
Order No.	2632770000	PCB plug-in connector, male plug, 7.62 mm, Number of poles: 4,
GTIN (EAN)	4050118646993	180°, PUSH IN with actuator, Tension-clamp connection, Clamping
Qty.	40 ST	range, max. : 2.5 mm ² , Box

SLF 7.62HP/180G

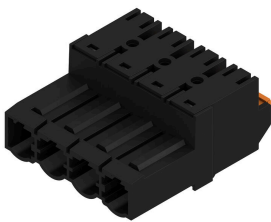

180° inverted male header with PUSH-IN connection technology for field wiring in 2.5 mm² with a 7.62 pitch. Also ideal as a touch-safe solution for inverse voltages. Meets the requirements of UL1059 600 V class C and IEC 61800-5-1.

Variants: available without flange, with external flange, with release latch.

General ordering data

Type	SLF 7.62HP/04/180G SN B...	Version
Order No.	1043610000	PCB plug-in connector, male plug, 7.62 mm, Number of poles: 4,
GTIN (EAN)	4032248775187	180°, PUSH IN with actuator, Tension-clamp connection, Clamping
Qty.	60 ST	range, max. : 2.5 mm ² , Box

BLL 7.62HP/04/180 3.2SN BK BX

Weidmüller Interface GmbH & Co. KG
 Klingenbergstraße 26
 D-32758 Detmold
 Germany

Counterpart

www.weidmueller.com

SLF 7.62HP/180LRSH

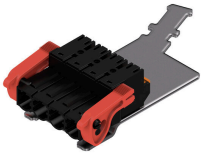

180° inverted male header with PUSH-IN connection technology for field wiring in 2.5 mm² with a 7.62 pitch. Also ideal as a touch-safe solution for inverse voltages. Meets the requirements of UL1059 600 V class C and IEC 61800-5-1.

Variants: available without flange, with external flange, with release latch. Including pre-assembled pluggable shield connection for large area shielding in your application.

General ordering data

Type	SLF 7.62HP/04/180LRSH18...	Version
Order No.	2614190000	PCB plug-in connector, male plug, 7.62 mm, Number of poles: 4,
GTIN (EAN)	4050118618051	180°, PUSH IN with actuator, Tension-clamp connection, Clamping
Qty.	40 ST	range, max. : 2.5 mm ² , Box
Type	SLF 7.62HP/04/180LRSH16...	Version
Order No.	2632780000	PCB plug-in connector, male plug, 7.62 mm, Number of poles: 4,
GTIN (EAN)	4050118647204	180°, PUSH IN with actuator, Tension-clamp connection, Clamping
Qty.	40 ST	range, max. : 2.5 mm ² , Box
Type	SLF 7.62HP/04/180LRSH20...	Version
Order No.	2632790000	PCB plug-in connector, male plug, 7.62 mm, Number of poles: 4,
GTIN (EAN)	4050118647211	180°, PUSH IN with actuator, Tension-clamp connection, Clamping
Qty.	40 ST	range, max. : 2.5 mm ² , Box

SLZ 7.62HP/180G



180° inverted male header with clamping yoke connection for field wiring in 2.5 mm² with a 7.62 pitch. Also ideal as a touch-safe solution for inverse voltages. Meets the requirements of UL1059 600 V class C and IEC 61800-5-1.

Variants: available without flange, with external flange or with release latch.

General ordering data

Type	SLZ 7.62HP/04/180G SN B...	Version
Order No.	1043370000	PCB plug-in connector, male plug, 7.62 mm, Number of poles: 4,
GTIN (EAN)	4032248774944	180°, Clamping yoke connection, Clamping range, max. : 2.5 mm ² ,
Qty.	60 ST	Box