

SAI-4-F 4P M12 L 5M**Weidmüller Interface GmbH & Co. KG**

Klingenbergstraße 26

D-32758 Detmold

Germany

www.weidmueller.com



M12 distributors are available in various versions. The 4, 6 or 8 M12 slots are in 4 or 5 pole design. The group outlet is designed as a fixed cable version, hood version for connection by the user, or with M23. Special versions are also available. For instance, there are 1-to-1 distributors for use with any connection types, or distributors approved for Ex Zone 1.

General ordering data

Version	Fixed cable version, M12, 30 V, A-coded, LED: Yes, LED initiator: Yes, Wiring type: PNP, 5 m
Order No.	1070650000
Type	SAI-4-F 4P M12 L 5M
GTIN (EAN)	403224882684 1
Qty.	1 items

SAI-4-F 4P M12 L 5M

Weidmüller Interface GmbH & Co. KG
 Klingenbergstraße 26
 D-32758 Detmold
 Germany

www.weidmueller.com

Technical data

Approvals

Approvals



ROHS Conform

UL File Number Search [UL Website](#)

Certificate No. (cURus) E92202

Dimensions and weights

Depth	144 mm	Depth (inches)	5.6693 inch
Height	18.2 mm	Height (inches)	0.7165 inch
Net weight	505 g		

Temperatures

Operating temperature -20 - 80°C

Environmental Product Compliance

RoHS Compliance Status Compliant without exemption

REACH SVHC No SVHC above 0.1 wt%

Connection data

Sheathing stripping length 100 mm Distributor outlet Fixed cable version

Electrical data

Rated voltage, min.	10 V	Rated voltage, max.	30 V
Test voltage	1 kV	Max. current-carrying capacity per slot	3 A
Total current	9 A	Current per signal	2 A
Electrical isolation available	No	Insulation resistance	109 Ω

General technical data

Protection degree	IP68	Plug-in station coding	A-coded
Number of poles	4	Cable pole count	7
Number of contact sockets	4	Connection thread	M12
Pollution severity	3	Fire behaviour	V-0
Plugging cycles	≤ 50	LED	Yes
LED initiator	Yes	LED colour for indicating operation	green
LED colour for I/O function	yellow		

Material data

Housing main material	PA 6 GF, PBT	Material of distributor	Plastic
Housing colour	grey, RAL 7032	Screw socket	Nickel-plated CuZn
Contact material	CuZn	Contact surface	Gold-plated
Contact carrier material	PBT (UL 94 V0)		

Technical data cable

Number of poles	4	Sheathing colour	black
O.D.	7.5 mm	Shielded	No

Creation date 24.02.2026 04:09:14 MEZ

Catalogue status / Drawings

SAI-4-F 4P M12 L 5M

Weidmüller Interface GmbH & Co. KG
 Klingenbergstraße 26
 D-32758 Detmold
 Germany

www.weidmueller.com

Technical data

Halogen	No	Bending radius, min., moving	10 x cable diameter
Bending cycles	2 Mio	Wire cross section (Print/Online)	4 x 0.34 mm ² + 3 x 1.0 mm ²
Sheath material	PUR	Colour coding	blue, brown, yellow, grey, green, Green/yellow, white
Cable length	5 m	Suitable for cable carriers	Yes

Classifications

ETIM 8.0	EC002585	ETIM 9.0	EC002585
ETIM 10.0	EC002585	ECLASS 14.0	27-44-01-08
ECLASS 15.0	27-44-01-08		

SAI-4-F 4P M12 L 5M

Weidmüller Interface GmbH & Co. KG
Klingenbergstraße 26
D-32758 Detmold
Germany

www.weidmueller.com

Drawings

Dimensioned drawing

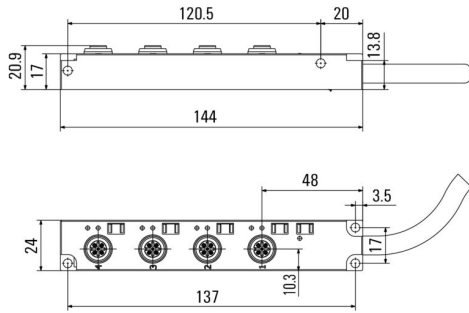

Dimensioned drawing

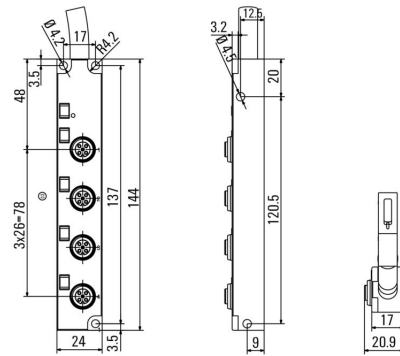

Wiring diagram

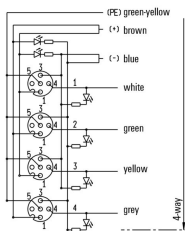

SAI-4-F 4P M12 L 5M

Weidmüller Interface GmbH & Co. KG
 Klingenbergstraße 26
 D-32758 Detmold
 Germany

www.weidmueller.com

Accessories

M12



Protective caps protect unassigned plug-in stations against external influences.

General ordering data

Type	SAI-SK-M12	Version	
Order No.	9456050000	Protected component assemblies, Protective cap	
GTIN (EAN)	4008190304058		
Qty.	30 ST		

Screwty® cable gland tool with torque function



The ideal tool for any application
 Screwty® is the ideal, all-purpose tool for tightening all common sensor and actuator cables. Even difficult-to-reach round plugs are accessible using the Screwty®. A simple turning movement tightens and loosens the connectors without the need for excessive force. The Screwty® is a unique and global solution since it fits with most cables and plugs from other vendors (over 90 %). The Screwty® consists of a handle with a conventional 1/4" adapter. Thus it can be used for all sizes: for M12 and M8 round plug-in connectors, and for M12F and M8F customisable plugs and sockets, as well as for all M23 plugs and sockets.

General ordering data

Type	SCREWTY SET -DM	Version	
Order No.	1920000000	Cable gland tool for M8, M12 lines and connectors	
GTIN (EAN)	4032248436859		
Qty.	1 ST		

SAI-4-F 4P M12 L 5M

Weidmüller Interface GmbH & Co. KG
 Klingenbergstraße 26
 D-32758 Detmold
 Germany

www.weidmueller.com

Accessories

Custom printing



WS markers are the perfect match for the W-series connectors. Thanks to their system compatibility, the WS tags can also be used with the I-series and the Z-series. The large marking surfaces do not only permit long character strings but also multi-line text. WS markers are ideal for labels with long, customised character strings. Thanks to the proven MultiCard format, printing with PrintJet CONNECT oder/or Plotter is possible.

- Can be fitted in strips or individually
- Markers in proven MultiCard format

For custom printing: Please send us a file of our labeling software M-Print PRO or M-Print PRO Online (without installation) for your labeling specifications.

General ordering data

Type	WS 10/5 MC SDR	Version
Order No.	1635010000	WS, Terminal marker, 10 x 5 mm, Pitch in mm (P): 5.00 Weidmueller,
GTIN (EAN)	4008190456634	Allen-Bradley, To customer specification
Qty.	144 ST	