

BLDF 5.08/08/180F SN OR BX

Weidmüller Interface GmbH & Co. KG

Klingenbergstraße 26

D-32758 Detmold

Germany

www.weidmueller.com

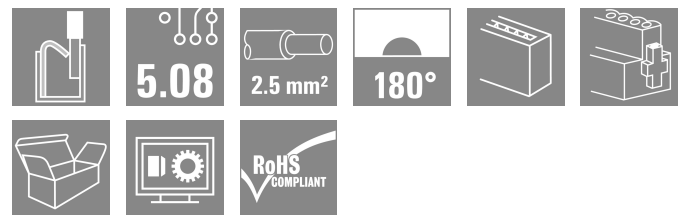
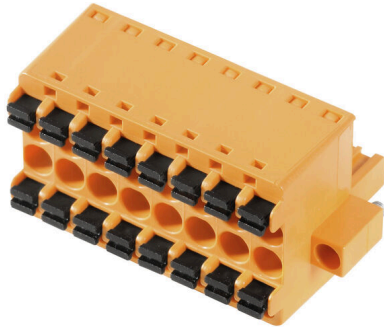

The powerful daisy-chain solution for high-performance signal bus applications is also suitable for 400V auxiliary power chains with 18.5A current-carrying capacity. The large clamping capacity (up to 2.5mm² wire cross-sections) is particularly beneficial for long bus cables or high currents because of the low voltage drop.

Four flange variations, including the patented release latch, allow for user-friendly unplugging designs.

General ordering data

Version	PCB plug-in connector, female plug, 5.08 mm, Number of poles: 8, 180°, PUSH IN with actuator, Clamping range, max. : 3.31 mm ² , Box
Order No.	1065120000
Type	BLDF 5.08/08/180F SN OR BX
GTIN (EAN)	4032248817658
Qty.	24 items
Product data	IEC: 400 V / 20.8 A / 0.2 - 2.5 mm ² UL: 300 V / 18.5 A / AWG 12 - AWG 26
Packaging	Box

BLDF 5.08/08/180F SN OR BX

Weidmüller Interface GmbH & Co. KG
 Klingenbergstraße 26
 D-32758 Detmold
 Germany

www.weidmueller.com

Technical data

Approvals

Approvals



ROHS	Conform
UL File Number Search	UL Website
Certificate No. (cURus)	E60693

Dimensions and weights

Depth	28.3 mm	Depth (inches)	1.1142 inch
Height	24.7 mm	Height (inches)	0.9724 inch
Width	50.44 mm	Width (inches)	1.9858 inch
Net weight	24.09 g		

Environmental Product Compliance

RoHS Compliance Status	Compliant without exemption
REACH SVHC	No SVHC above 0.1 wt%

System Parameters

Product family	OMNIMATE Signal - series BL/SL 5.08		
Type of connection	Field connection		
Wire connection method	PUSH IN with actuator		
Pitch in mm (P)	5.08 mm		
Pitch in inches (P)	0.200 "		
Conductor outlet direction	180°		
Number of poles	8		
L1 in mm	35.56 mm		
L1 in inches	1.400 "		
Number of rows	1		
Pin series quantity	1		
Rated cross-section	2.5 mm ²		
Touch-safe protection acc. to DIN VDE 57 106	Safe from finger touch		
Touch-safe protection acc. to DIN VDE 0470	IP20 plugged/ IP10 unplugged		
Protection degree	IP20		
Volume resistance	≤5 mΩ		
Can be coded	Yes		
Stripping length	10 mm		
Screwdriver blade	0.6 x 3.5		
Screwdriver blade standard	DIN 5264		
Plugging cycles	25		
Plugging force/pole, max.	9.5 N		
Pulling force/pole, max.	7.5 N		
Tightening torque	Torque type	Screw flange	
	Usage information	Tightening torque	min. 0.2 Nm max. 0.25 Nm

Material data

Insulating material	PBT	Colour	orange
Colour of operational elements	black	Colour chart (similar)	RAL 2000

BLDF 5.08/08/180F SN OR BX

Weidmüller Interface GmbH & Co. KG
 Klingenbergstraße 26
 D-32758 Detmold
 Germany

www.weidmueller.com

Technical data

Insulating material group	IIIa	Comparative Tracking Index (CTI)	≥ 200
Moisture Level (MSL)		UL 94 flammability rating	V-0
Contact material	Cu-alloy	Contact surface	tinned
Layer structure of plug contact	4...8 µm Sn hot-dip tinned	Storage temperature, min.	-40 °C
Storage temperature, max.	70 °C	Operating temperature, min.	-50 °C
Operating temperature, max.	100 °C	Temperature range, installation, min.	-30 °C
Temperature range, installation, max.	100 °C		

Conductors suitable for connection

Clamping range, min.	0.13 mm ²
Clamping range, max.	3.31 mm ²
Wire connection cross section AWG, min.	AWG 26
Wire connection cross section AWG, max.	AWG 12
Solid, min. H05(07) V-U	0.2 mm ²
Solid, max. H05(07) V-U	2.5 mm ²
Flexible, min. H05(07) V-K	0.2 mm ²
Flexible, max. H05(07) V-K	2.5 mm ²
w. plastic collar ferrule, DIN 46228 pt 4, min.	0.25 mm ²
w. plastic collar ferrule, DIN 46228 pt 4, max.	2.5 mm ²
w. wire end ferrule, DIN 46228 pt 1, min.	0.25 mm ²
w. wire end ferrule, DIN 46228 pt 1, max.	2.5 mm ²
Plug gauge in accordance with EN 60999 a x b; ø	2.8 mm x 2.0 mm

Clampable conductor	Cross-section for conductor connection	Type	fine-wired
		nominal	0.5 mm ²
wire end ferrule	wire end ferrule	Stripping length	nominal 12 mm
		Recommended wire-end ferrule	H0,5/16 OR
		Stripping length	nominal 10 mm
		Recommended wire-end ferrule	H0,5/10
Cross-section for conductor connection	wire end ferrule	Type	fine-wired
		nominal	0.75 mm ²
		Stripping length	nominal 12 mm
		Recommended wire-end ferrule	H0,75/16 W
Cross-section for conductor connection	wire end ferrule	Stripping length	nominal 10 mm
		Recommended wire-end ferrule	H0,75/10
		Type	fine-wired
		nominal	1 mm ²
Cross-section for conductor connection	wire end ferrule	Stripping length	nominal 12 mm
		Recommended wire-end ferrule	H1,0/16D R
		Stripping length	nominal 10 mm
		Recommended wire-end ferrule	H1,0/10
Cross-section for conductor connection	wire end ferrule	Type	fine-wired
		nominal	1.5 mm ²
		Stripping length	nominal 10 mm
		Recommended wire-end ferrule	H1,5/10
		Stripping length	nominal 12 mm

BLDF 5.08/08/180F SN OR BX

Weidmüller Interface GmbH & Co. KG
 Klingenbergstraße 26
 D-32758 Detmold
 Germany

www.weidmueller.com

Technical data

		Recommended wire-end ferrule	H1.5/16 R
Cross-section for conductor connection	Type	fine-wired	
	nominal	2.5 mm ²	
wire end ferrule	Stripping length	nominal	10 mm
	Recommended wire-end ferrule	H2.5/10	
	Stripping length	nominal	13 mm
	Recommended wire-end ferrule	H2.5/16DS BL	
Reference text	The outside diameter of the plastic collar should not be larger than the pitch (P), Length of ferrules is to be chosen depending on the product and the rated voltage.		

Rated data acc. to IEC

tested acc. to standard	IEC 60664-1, IEC 61984	Rated current, min. number of poles (Tu=20°C)	20.8 A
Rated current, max. number of poles (Tu=20°C)	17.4 A	Rated current, min. number of poles (Tu=40°C)	17.9 A
Rated current, max. number of poles (Tu=40°C)	14.9 A	Rated current cross-connector, min. number of poles (Ta=20°C)	28.1 A
Rated current cross-connector, max. number of poles (Ta=20°C)	23.3 A	Rated current cross-connector, min. number of poles (Ta=40°C)	24.2 A
Rated current cross-connector, max. number of poles (Ta=40°C)	19.9 A	Rated voltage for surge voltage class / pollution degree II/2	400 V
Rated voltage for surge voltage class / pollution degree III/2	320 V	Rated voltage for surge voltage class / pollution degree III/3	250 V
Rated impulse voltage for surge voltage class/ pollution degree II/2	4 kV	Rated impulse voltage for surge voltage class/ pollution degree III/2	4 kV
Rated impulse voltage for surge voltage class/ contamination degree III/3	4 kV	Short-time withstand current resistance	3 x 1s with 120 A

Rated data acc. to CSA

Institute (CSA)	CSA	Certificate No. (CSA)	200039-1121690
Rated voltage (Use group B / CSA)	300 V	Rated voltage (Use group D / CSA)	300 V
Rated current (Use group B / CSA)	18.5 A	Rated current (Use group D / CSA)	10 A
Wire cross-section, AWG, min.	AWG 12	Wire cross-section, AWG, max.	AWG 26
Reference to approval values	Specifications are maximum values, details - see approval certificate.		

Rated data acc. to UL 1059

Institute (cURus)	CURUS	Certificate No. (cURus)	E60693
Rated voltage (Use group B / UL 1059)	300 V	Rated voltage (Use group D / UL 1059)	300 V
Rated current (Use group B / UL 1059)	18.5 A	Rated current (Use group D / UL 1059)	10 A
Wire cross-section, AWG, min.	AWG 12	Wire cross-section, AWG, max.	AWG 26
Reference to approval values	Specifications are maximum values, details - see approval certificate.		

Packing

Packaging	Box	VPE length	351.00 mm
VPE width	142.00 mm	VPE height	40.00 mm

BLDF 5.08/08/180F SN OR BX

Weidmüller Interface GmbH & Co. KG
 Klingenbergstraße 26
 D-32758 Detmold
 Germany

www.weidmueller.com

Technical data

Cross-connector rated data according to DIN IEC

Rated current cross-connector, max. number of poles (Ta=40°C)	19.9 A	Rated current cross-connector, min. number of poles (Ta=20°C)	28.1 A
Rated current cross-connector, min. number of poles (Ta=40°C)	24.2 A	Rated current cross-connector, max. number of poles (Ta=20°C)	23.3 A

Important note

IPC conformity Conformity: The products are developed, manufactured and delivered according international recognized standards and norms and comply with the assured properties in the data sheet resp. fulfill decorative properties in accordance with IPC-A-610 "Class 2". Further claims on the products can be evaluated on request.

- Notes**
- Additional variants on request
 - Gold-plated contact surfaces on request
 - Rated current related to rated cross-section & min. No. of poles.
 - Wire end ferrule without plastic collar to DIN 46228/1
 - Wire end ferrule with plastic collar to DIN 46228/4
 - P on drawing = pitch
 - Crimping shape "A" for wire end ferrules with PZ 6/5 crimping tool recommended.
 - The test point can only be used as potential-pickup point.
 - In accordance with IEC 61984, OMNIMATE-connectors are connectors without breaking capacity (COC). During designated use, connectors are not allowed to be engaged or disengaged when live or under load
 - Long term storage of the product with average temperature of 50 °C and maximum humidity 70%, 36 months

Classifications

ETIM 8.0	EC002638	ETIM 9.0	EC002638
ETIM 10.0	EC002638	ECLASS 14.0	27-46-02-02
ECLASS 15.0	27-46-02-02		

BLDF 5.08/08/180F SN OR BX

Weidmüller Interface GmbH & Co. KG
 Klingenbergstraße 26
 D-32758 Detmold
 Germany

www.weidmueller.com

Drawings

Product image

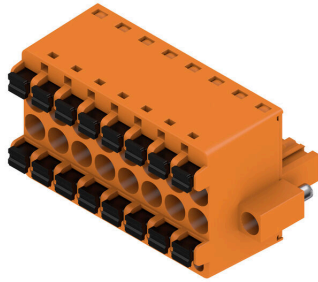

Dimensional drawing

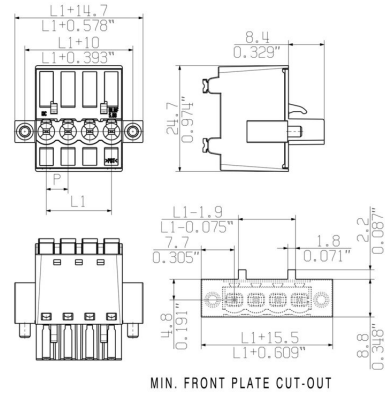

Graph

BLDF 5.08/180 - SL 5.08HC/..90



Graph

BLDF 5.08/180 - SL 5.08HC/..90



Uncompromising functionality High vibration resistance

Drawings

Product benefits



Solid PUSH IN contact Safe and durable

Product benefits



Cost-effective wiring Quick and intuitive operation

Product benefits



Wide clamping range Tool-free wire connection

BLDF 5.08/08/180F SN OR BX

Weidmüller Interface GmbH & Co. KG
 Klingenbergstraße 26
 D-32758 Detmold
 Germany

www.weidmueller.com

Accessories

Coding elements



Only connects what is supposed to be connected: the right connection at the right place.
 Coding elements and locking devices clearly assign connecting elements during the manufacturing process and operation
 The coding elements and locking devices are inserted prior to assembly or during the cable assembly phase. The Weidmüller alternative: configure online using the variant configurator to precode prior to delivery. Incorrect assembly on the circuit board and incorrect plugging of connecting elements is no longer possible. The advantage: no troubleshooting during manufacture and no operational errors by the user.

General ordering data

Type	BLZ/SL KO BK BX	Version
Order No.	1545710000	PCB plug-in connector, Accessories, Coding element, black, Number of poles: 1
GTIN (EAN)	4008190087142	
Qty.	50 ST	
Type	BLZ/SL KO OR BX	Version
Order No.	1573010000	PCB plug-in connector, Accessories, Coding element, orange, Number of poles: 1
GTIN (EAN)	4008190048396	
Qty.	100 ST	

Slotted screwdriver



Slotted screwdriver with rounded blade SD DIN 5265, ISO 2380/2, output to DIN 5264, ISO 2380/1. ChromTop tip, SoftFinish grip

General ordering data

Type	SDS 0.6X3.5X100	Version
Order No.	2749340000	Screwdriver, Blade width (B): 3.5 mm, Blade length: 100 mm, Blade thickness (A): 0.6 mm
GTIN (EAN)	4050118895568	
Qty.	1 ST	
Type	SDS 0.6X3.5X200	Version
Order No.	9010110000	Screwdriver, Screwdriver
GTIN (EAN)	4032248300754	
Qty.	1 ST	
Type	SDIS 0.6X3.5X100	Version
Order No.	2749810000	Screwdriver, Blade width (B): 3.5 mm, Blade length: 100 mm, Blade thickness (A): 0.6 mm
GTIN (EAN)	4050118897012	
Qty.	1 ST	

BLDF 5.08/08/180F SN OR BX

Weidmüller Interface GmbH & Co. KG
Klingenbergstraße 26
D-32758 Detmold
Germany

Counterpart

www.weidmueller.com

SL 5.08HC/180F



Pin headers in glass-fibre-reinforced plastic with straight wire outlet; optimised for wave soldering. The flange variant (F) can be screwed onto the respective counter piece or the circuit board. There is no need for an extra screw to connect the circuit board when the solder flange (LF) version is used. This also protects the solder points from mechanical strain. All pin headers can be manually coded or ordered pre-coded. HC = High Current.

General ordering data

Type	SL 5.08HC/08/180F 3.2SN...	Version
Order No.	1148650000	PCB plug-in connector, male header, Flange, THT solder connection,
GTIN (EAN)	4032248931767	5.08 mm, Number of poles: 8, 180°, Solder pin length (l): 3.2 mm,
Qty.	36 ST	tinned, black, Box
Type	SL 5.08HC/08/180F 3.2SN...	Version
Order No.	1147320000	PCB plug-in connector, male header, Flange, THT solder connection,
GTIN (EAN)	4032248931262	5.08 mm, Number of poles: 8, 180°, Solder pin length (l): 3.2 mm,
Qty.	36 ST	tinned, orange, Box

SL 5.08HC/180LF

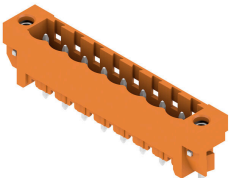

Pin headers in glass-fibre-reinforced plastic with straight wire outlet; optimised for wave soldering. The flange variant (F) can be screwed onto the respective counter piece or the circuit board. There is no need for an extra screw to connect the circuit board when the solder flange (LF) version is used. This also protects the solder points from mechanical strain. All pin headers can be manually coded or ordered pre-coded. HC = High Current.

General ordering data

Type	SL 5.08HC/08/180LF 3.2S...	Version
Order No.	1149420000	PCB plug-in connector, male header, Solder flange, THT solder
GTIN (EAN)	4032248932467	connection, 5.08 mm, Number of poles: 8, 180°, Solder pin length (l):
Qty.	36 ST	3.2 mm, tinned, black, Box
Type	SL 5.08HC/08/180LF 3.2S...	Version
Order No.	1148090000	PCB plug-in connector, male header, Solder flange, THT solder
GTIN (EAN)	4032248931286	connection, 5.08 mm, Number of poles: 8, 180°, Solder pin length (l):
Qty.	36 ST	3.2 mm, tinned, orange, Box

BLDF 5.08/08/180F SN OR BX

Weidmüller Interface GmbH & Co. KG
 Klingenbergstraße 26
 D-32758 Detmold
 Germany

Counterpart

www.weidmueller.com

SL 5.08HC/90F



Pin headers made from glass-fibre-reinforced plastic with 90° wire outlet; optimised for wave soldering. The flange variant (F) can be screwed onto the respective counter piece or the circuit board. There is no need for an extra screw to connect the circuit board when the solder flange (LF) version is used. This also protects the solder points from mechanical strain. All pin headers can be manually coded or ordered pre-coded. HC = High Current.

General ordering data

Type	SL 5.08HC/08/90F 3.2SN ...	Version
Order No.	1150150000	PCB plug-in connector, male header, Flange, THT solder connection,
GTIN (EAN)	4032248936243	5.08 mm, Number of poles: 8, 90°, Solder pin length (l): 3.2 mm,
Qty.	36 ST	tinned, black, Box
Type	SL 5.08HC/08/90F 3.2SN ...	Version
Order No.	1148810000	PCB plug-in connector, male header, Flange, THT solder connection,
GTIN (EAN)	4032248107308	5.08 mm, Number of poles: 8, 90°, Solder pin length (l): 3.2 mm,
Qty.	36 ST	tinned, orange, Box

SL 5.08HC/90LF



Pin headers made from glass-fibre-reinforced plastic with 90° wire outlet; optimised for wave soldering. The flange variant (F) can be screwed onto the respective counter piece or the circuit board. There is no need for an extra screw to connect the circuit board when the solder flange (LF) version is used. This also protects the solder points from mechanical strain. All pin headers can be manually coded or ordered pre-coded. HC = High Current.

General ordering data

Type	SL 5.08HC/08/90LF 3.2SN...	Version
Order No.	1150410000	PCB plug-in connector, male header, Solder flange, THT solder
GTIN (EAN)	4032248105861	connection, 5.08 mm, Number of poles: 8, 90°, Solder pin length (l):
Qty.	36 ST	3.2 mm, tinned, black, Box
Type	SL 5.08HC/08/90LF 3.2SN...	Version
Order No.	1149580000	PCB plug-in connector, male header, Solder flange, THT solder
GTIN (EAN)	4032248936120	connection, 5.08 mm, Number of poles: 8, 90°, Solder pin length (l):
Qty.	36 ST	3.2 mm, tinned, orange, Box

BLDF 5.08/08/180F SN OR BX

Weidmüller Interface GmbH & Co. KG
 Klingenbergstraße 26
 D-32758 Detmold
 Germany

Counterpart

www.weidmueller.com

SL-SMT 5.08/180F Box



High-temperature-resistant pin header, packed in box or tape. On tape, with 1.5 mm solder pin, optimised for automatic assembly. 3.2 mm solder pin suitable for reflow and wave soldering. The pin headers provide space for labelling and can be coded. HC = High Current.

General ordering data

Type	SL-SMT 5.08HC/08/180F 3...	Version
Order No.	1820620000	PCB plug-in connector, male header, Flange, THT/THR solder
GTIN (EAN)	4032248316588	connection, 5.08 mm, Number of poles: 8, 180°, Solder pin length (l):
Qty.	36 ST	3.2 mm, tinned, black, Box

SL-SMT 5.08/180LF Box



High-temperature-resistant pin header, packed in box or tape. On tape, with 1.5 mm solder pin, optimised for automatic assembly. 3.2 mm solder pin suitable for reflow and wave soldering. The pin headers provide space for labelling and can be coded. HC = High Current.

General ordering data

Type	SL-SMT 5.08HC/08/180LF ...	Version
Order No.	1776422001	PCB plug-in connector, male header, Solder flange, THT/THR solder
GTIN (EAN)	4032248159208	connection, 5.08 mm, Number of poles: 8, 180°, Solder pin length (l):
Qty.	36 ST	1.5 mm, tinned, black, Box
Type	SL-SMT 5.08HC/08/180LF ...	Version
Order No.	1838500000	PCB plug-in connector, male header, Solder flange, THT/THR solder
GTIN (EAN)	4032248348565	connection, 5.08 mm, Number of poles: 8, 180°, Solder pin length (l):
Qty.	36 ST	3.2 mm, tinned, black, Box

SL-SMT 5.08/270FH Box



High-temperature-resistant, straight, open pin header. Packed in box or tape. On tape and with 1.5 mm solder pin, optimised for automatic assembly. 3.2 mm solder pin suitable for reflow and wave soldering. The pin headers provide space for labelling and can be coded. HC = High Current.

BLDF 5.08/08/180F SN OR BX

Weidmüller Interface GmbH & Co. KG
Klingenbergstraße 26
D-32758 Detmold
Germany

Counterpart

www.weidmueller.com

General ordering data

Type	SL-SMT 5.08HC/08/270FH ...	Version
Order No.	1878020000	PCB plug-in connector, male header, Solder flange, THT/THR solder
GTIN (EAN)	4032248468775	connection, 5.08 mm, Number of poles: 8, 270°, Solder pin length (l):
Qty.	50 ST	1.5 mm, tinned, black, Box
Type	SL-SMT 5.08HC/08/270FH ...	Version
Order No.	1877500000	PCB plug-in connector, male header, Solder flange, THT/THR solder
GTIN (EAN)	4032248468126	connection, 5.08 mm, Number of poles: 8, 270°, Solder pin length (l):
Qty.	50 ST	3.2 mm, tinned, black, Box

SL-SMT 5.08/270FH Tape



High-temperature-resistant, straight, open pin header. Packed in box or tape. On tape and with 1.5 mm solder pin, optimised for automatic assembly. 3.2 mm solder pin suitable for reflow and wave soldering. The pin headers provide space for labelling and can be coded. HC = High Current.

General ordering data

Type	SL-SMT 5.08HC/08/270FH ...	Version
Order No.	1876980000	PCB plug-in connector, male header, Solder flange, THT/THR solder
GTIN (EAN)	4032248467631	connection, 5.08 mm, Number of poles: 8, 270°, Solder pin length (l):
Qty.	195 ST	1.5 mm, tinned, black, Tape

SL-SMT 5.08/270FL Box



High-temperature-resistant, straight, open pin header. Packed in box or tape. On tape and with 1.5 mm solder pin, optimised for automatic assembly. 3.2 mm solder pin suitable for reflow and wave soldering. The pin headers provide space for labelling and can be coded. HC = High Current.

General ordering data

Type	SL-SMT 5.08HC/08/270FL ...	Version
Order No.	1876910000	PCB plug-in connector, male header, Solder flange, THT/THR solder
GTIN (EAN)	4032248467495	connection, 5.08 mm, Number of poles: 8, 270°, Solder pin length (l):
Qty.	50 ST	3.2 mm, tinned, black, Box

BLDF 5.08/08/180F SN OR BX

Weidmüller Interface GmbH & Co. KG
 Klingenbergstraße 26
 D-32758 Detmold
 Germany

www.weidmueller.com

Counterpart

SL-SMT 5.08/270FL Tape

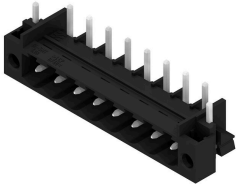

High-temperature-resistant, straight, open pin header. Packed in box or tape. On tape and with 1.5 mm solder pin, optimised for automatic assembly. 3.2 mm solder pin suitable for reflow and wave soldering. The pin headers provide space for labelling and can be coded. HC = High Current.

General ordering data

Type	SL-SMT 5.08HC/08/270FL ...	Version
Order No.	1877120000	PCB plug-in connector, male header, Solder flange, THT/THR solder
GTIN (EAN)	4032248467716	connection, 5.08 mm, Number of poles: 8, 270°, Solder pin length (l):
Qty.	300 ST	1.5 mm, tinned, black, Tape

SL-SMT 5.08HC/90F Box



High-temperature-resistant pin header, packed in box or tape. On tape, with 1.5 mm solder pin, optimised for automatic assembly. 3.2 mm solder pin suitable for reflow and wave soldering. The pin headers provide space for labelling and can be coded. HC = High Current.

General ordering data

Type	SL-SMT 5.08HC/08/90F 3...	Version
Order No.	1837690000	PCB plug-in connector, male header, Flange, THT/THR solder
GTIN (EAN)	4032248347506	connection, 5.08 mm, Number of poles: 8, 90°, Solder pin length (l):
Qty.	36 ST	3.2 mm, tinned, black, Box

SL-SMT 5.08HC/90LF Box



High-temperature-resistant pin header, packed in box or tape. On tape, with 1.5 mm solder pin, optimised for automatic assembly. 3.2 mm solder pin suitable for reflow and wave soldering. The pin headers provide space for labelling and can be coded. HC = High Current.

General ordering data

Type	SL-SMT 5.08HC/08/90LF 1...	Version
Order No.	1775292001	PCB plug-in connector, male header, Solder flange, THT/THR solder
GTIN (EAN)	4032248157273	connection, 5.08 mm, Number of poles: 8, 90°, Solder pin length (l):
Qty.	36 ST	1.5 mm, tinned, black, Box

BLDF 5.08/08/180F SN OR BX

Weidmüller Interface GmbH & Co. KG
 Klingenbergstraße 26
 D-32758 Detmold
 Germany

www.weidmueller.com

Counterpart

Type	SL-SMT 5.08HC/08/90LF 3...	Version
Order No.	1780470000	PCB plug-in connector, male header, Solder flange, THT/THR solder
GTIN (EAN)	4032248165797	connection, 5.08 mm, Number of poles: 8, 90°, Solder pin length (l):
Qty.	36 ST	3.2 mm, tinned, black, Box

SLDV-THR 5.08/180F



High-temperature resistant, double level, laterally offset, male connector with flange or solder flange. 1.5 mm solder pin is suitable for reflow soldering. 3.2 mm solder pin suitable for reflow and wave soldering. The pin headers provide space for labelling and can be coded.

General ordering data

Type	SLDV-THR 5.08/16/180F 1...	Version
Order No.	1828950000	PCB plug-in connector, male header, Flange, THT/THR solder
GTIN (EAN)	4032248335640	connection, 5.08 mm, Number of poles: 16, 180°, Solder pin length
Qty.	20 ST	(l): 1.5 mm, tinned, black, Box
Type	SLDV-THR 5.08/16/180F 3...	Version
Order No.	1828830000	PCB plug-in connector, male header, Flange, THT/THR solder
GTIN (EAN)	4032248335527	connection, 5.08 mm, Number of poles: 16, 180°, Solder pin length
Qty.	20 ST	(l): 3.2 mm, tinned, black, Box

SLDV-THR 5.08/180FLF



High-temperature resistant, double level, laterally offset, male connector with flange or solder flange. 1.5 mm solder pin is suitable for reflow soldering. 3.2 mm solder pin suitable for reflow and wave soldering. The pin headers provide space for labelling and can be coded.

General ordering data

Type	SLDV-THR 5.08/16/180FLF...	Version
Order No.	1829190000	PCB plug-in connector, male header, Flange / Solder flange, THT/THR
GTIN (EAN)	4032248335886	solder connection, 5.08 mm, Number of poles: 16, 180°, Solder pin
Qty.	20 ST	length (l): 1.5 mm, tinned, black, Box
Type	SLDV-THR 5.08/16/180FLF...	Version
Order No.	1829070000	PCB plug-in connector, male header, Flange / Solder flange, THT/THR
GTIN (EAN)	4032248335763	solder connection, 5.08 mm, Number of poles: 16, 180°, Solder pin
Qty.	20 ST	length (l): 3.2 mm, tinned, black, Box

BLDF 5.08/08/180F SN OR BX

Weidmüller Interface GmbH & Co. KG
 Klingenbergstraße 26
 D-32758 Detmold
 Germany

Counterpart

www.weidmueller.com

SLF 5.08/180F SN

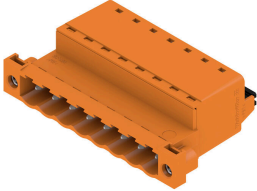

Male plug with PUSH IN wire connection and straight outlet direction, when used with BLF 5.08HC as wire-to-wire application for panel feed-through The male plugs provide space for labelling and can be coded.

General ordering data

Type	SLF 5.08/08/180F SN BK ...	Version
Order No.	1336230000	PCB plug-in connector, male plug, 5.08 mm, Number of poles: 8,
GTIN (EAN)	4050118139907	180°, PUSH IN with actuator, Clamping range, max. : 3.31 mm ² , Box
Qty.	36 ST	
Type	SLF 5.08/08/180F SN OR ...	Version
Order No.	1335720000	PCB plug-in connector, male plug, 5.08 mm, Number of poles: 8,
GTIN (EAN)	4050118139440	180°, PUSH IN with actuator, Clamping range, max. : 3.31 mm ² , Box
Qty.	36 ST	

SLF 5.08/180FI SN

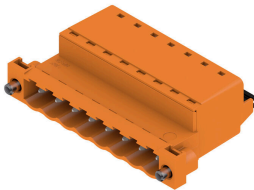

Male plug with PUSH IN wire connection and straight outlet direction, when used with BLF 5.08HC as wire-to-wire application for panel feed-through The male plugs provide space for labelling and can be coded.

General ordering data

Type	SLF 5.08/08/180FI SN BK...	Version
Order No.	1336110000	PCB plug-in connector, male plug, 5.08 mm, Number of poles: 8,
GTIN (EAN)	4050118139822	180°, PUSH IN with actuator, Clamping range, max. : 3.31 mm ² , Box
Qty.	36 ST	
Type	SLF 5.08/08/180FI SN OR...	Version
Order No.	1336470000	PCB plug-in connector, male plug, 5.08 mm, Number of poles: 8,
GTIN (EAN)	4050118140507	180°, PUSH IN with actuator, Clamping range, max. : 3.31 mm ² , Box
Qty.	36 ST	

BLDF 5.08/08/180F SN OR BX

Weidmüller Interface GmbH & Co. KG
 Klingenbergstraße 26
 D-32758 Detmold
 Germany

www.weidmueller.com

Counterpart

SLS 5.08/180F



Male plugs with clamping-yoke screw wire-connect system. The male plugs provide space for labelling and can be coded.

General ordering data

Type	SLS 5.08/08/180F SN OR ...	Version
Order No.	1846420000	PCB plug-in connector, male plug, 5.08 mm, Number of poles: 8,
GTIN (EAN)	4032248362721	180°, Clamping yoke connection, Clamping range, max. : 3.31 mm ² ,
Qty.	36 ST	Box

SLS 5.08/180FI



Male plugs with clamping-yoke screw wire-connect system. The male plugs provide space for labelling and can be coded.

General ordering data

Type	SLS 5.08/08/180FI SN OR...	Version
Order No.	1846270000	PCB plug-in connector, male plug, 5.08 mm, Number of poles: 8,
GTIN (EAN)	4032248362554	180°, Clamping yoke connection, Clamping range, max. : 3.31 mm ² ,
Qty.	36 ST	Box