

SHL-SMT 5.00/03GL 1.5RL

Weidmüller Interface GmbH & Co. KG
 Klingenbergstraße 26
 D-32758 Detmold
 Germany

www.weidmueller.com

Product image

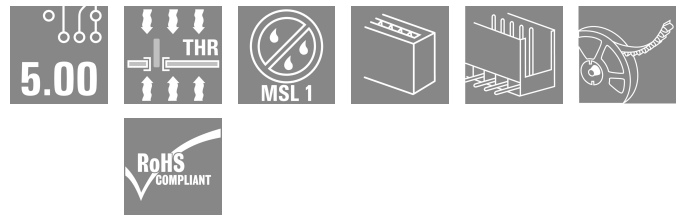
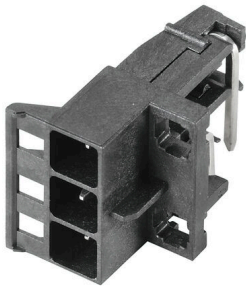

Male connectors with solder pin length optimised for wave flow soldering. The pin headers provide space for labelling and can be coded.

General ordering data

Version	PCB plug-in connector, Connection element, left, male header, open side, THT/THR solder connection, 5.00 mm, Number of poles: 3, 90°, Solder pin length (l): 1.5 mm, tinned, black, Tape
Order No.	1063240000
Type	SHL-SMT 5.00/03GL 1.5RL
GTIN (EAN)	4032248814909
Qty.	175 items
Product data	IEC: 400 V UL: 300 V / 9 A / AWG 26 - AWG 12
Packaging	Tape

SHL-SMT 5.00/03GL 1.5RL

Weidmüller Interface GmbH & Co. KG
Klingenbergstraße 26
D-32758 Detmold
Germany

www.weidmueller.com

Technical data

Approvals

Approvals	CSA; CURUS
ROHS	Conform
UL File Number Search	UL Website
Certificate No. (cURus)	E60693

Dimensions and weights

Depth	23.2 mm	Depth (inches)	0.9134 inch
Height	14.4 mm	Height (inches)	0.5669 inch
Height of lowest version	11.2 mm	Width	15.6 mm
Width (inches)	0.6142 inch	Length	0 mm
Net weight	1.89 g		

Environmental Product Compliance

RoHS Compliance Status	Compliant without exemption
REACH SVHC	No SVHC above 0.1 wt%

System Parameters

Product family	OMNIMATE Housing - series CH20M	Type of connection	Board connection
Pitch in mm (P)	5.00 mm	Pitch in inches (P)	0.197 "
Number of poles	3	L1 in mm	10.00 mm
L1 in inches	0.394 "	Number of rows	1
Pin series quantity	1	Protection degree	IP20
Volume resistance	≤5 mΩ	Can be coded	Yes

Material data

Insulating material	LCP	Colour	black
Colour chart (similar)	RAL 9011	Insulating material group	IIIa
Comparative Tracking Index (CTI)	175 ≤ CTI <400	Moisture Level (MSL)	1
UL 94 flammability rating	V-0	Contact material	Copper alloy
Contact surface	tinned	Storage temperature, min.	-40 °C
Storage temperature, max.	70 °C	Operating temperature, min.	-40 °C
Operating temperature, max.	120 °C	Temperature range, installation, min.	-30 °C
Temperature range, installation, max.	120 °C		

Rated data acc. to IEC

tested acc. to standard	IEC 60664-1, IEC 61984	Rated current, max. number of poles (Tu=20°C)	10 A
Rated current, max. number of poles (Tu=40°C)	9 A	Rated voltage for surge voltage class / pollution degree II/2	400 V
Rated voltage for surge voltage class / pollution degree III/2	320 V	Rated voltage for surge voltage class / pollution degree III/3	250 V
Rated impulse voltage for surge voltage class/ pollution degree II/2	4 kV	Rated impulse voltage for surge voltage class/ pollution degree III/2	4 kV
Rated impulse voltage for surge voltage class/ contamination degree III/3	4 kV		

Rated data acc. to CSA

Institute (CSA)	CSA	Certificate No. (CSA)	200039-70153051
Rated voltage (Use group B / CSA)	300 V	Rated voltage (Use group C / CSA)	50 V

SHL-SMT 5.00/03GL 1.5RL

Weidmüller Interface GmbH & Co. KG

Klingenbergstraße 26
D-32758 Detmold
Germany

www.weidmueller.com

Technical data

Rated voltage (Use group D / CSA)	300 V	Rated current (Use group B / CSA)	9 A
Rated current (Use group C / CSA)	9 A	Rated current (Use group D / CSA)	9 A
Wire cross-section, AWG, min.	AWG 26	Wire cross-section, AWG, max.	AWG 12
Reference to approval values	Specifications are maximum values, details - see approval certificate.		

Rated data acc. to UL 1059

Institute (cURus)	CURUS	Certificate No. (cURus)	E60693
Rated voltage (Use group B / UL 1059)	300 V	Rated voltage (Use group C / UL 1059)	50 V
Rated voltage (Use group D / UL 1059)	300 V	Rated current (Use group B / UL 1059)	9 A
Rated current (Use group C / UL 1059)	9 A	Rated current (Use group D / UL 1059)	9 A
Wire cross-section, AWG, min.	AWG 26	Wire cross-section, AWG, max.	AWG 12
Reference to approval values	Specifications are maximum values, details - see approval certificate.		

Material data

UL 94 flammability rating	V-0	Insulating material	LCP
Insulating material group	IIIa	Comparative Tracking Index (CTI)	175 ≤ CTI <400

General data

Colour	black	Protection degree	IP20
Colour chart (similar)	RAL 9011	Encapsulation option	No

Important note

IPC conformity	Conformity: The products are developed, manufactured and delivered according international recognized standards and norms and comply with the assured properties in the data sheet resp. fulfill decorative properties in accordance with IPC-A-6 10 "Class 2". Further claims on the products can be evaluated on request.
----------------	---

Classifications

ETIM 8.0	EC002637	ETIM 9.0	EC002637
ETIM 10.0	EC002637	ECLASS 14.0	27-46-02-01
ECLASS 15.0	27-46-02-01		

Drawings

Example of use



Dimensioned drawing

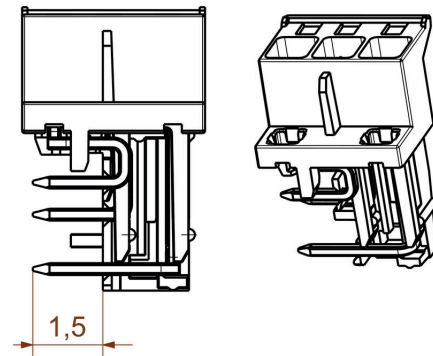

Example of use



delivery

Example of use



delivery