

## LXXX 15.00/03/90FR 4.5SN GY BX

**Weidmüller Interface GmbH & Co. KG**  
 Klingenbergstraße 26  
 D-32758 Detmold  
 Germany

www.weidmueller.com

### Product image

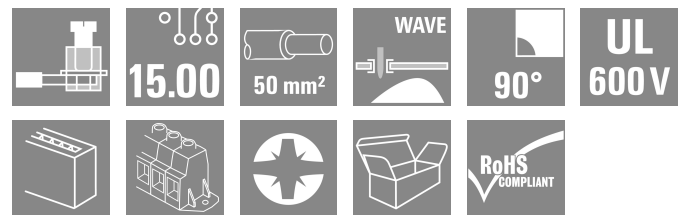
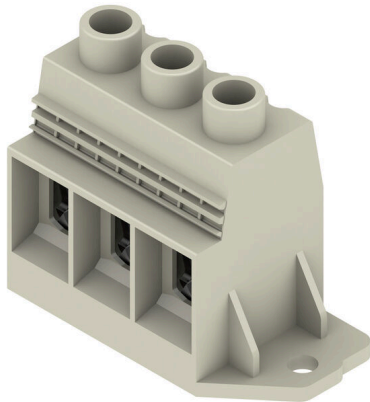

The high-current PCB connection for more power on board: 150 A / 1000 V with wires up to 50 mm<sup>2</sup>, transmitted right to the PCB!

The LXXX 15.0 – with its proven steel clamping-yoke technology in a compact standard housing – integrates the latest market requirements for security, power density and miniaturization in power electronics. It connects these requirements into an efficient solution for the entire value-creation chain – including development, production, installation and maintenance.

The function and form of the application's connection method plays a key role. It influences the application's design, reliability, usability and costs. With the Substitution of

For example, with the replacement of complex constructions involving bolts or bus bars, the PCB can be transformed into a system platform that is both consistent and sustainable into the future – even for high-current applications.

The LXXX 15.0 reduces size and complexity while at the same time improving application integration. In so doing, it fulfils the requirements of power electronics better than the established mechanisms and connection elements.

### General ordering data

Version	Printed circuit board terminals, 15.00 mm, Number of poles: 3, 90°, Solder pin length (l): 4.5 mm, tinned, Pebble grey, Clamping yoke connection, Clamping range, max.: 50 mm <sup>2</sup> , Box
Order No.	<a href="#">1047700000</a>
Type	LXXX 15.00/03/90FR 4.5SN GY BX
GTIN (EAN)	4032248783458
Qty.	10 items
Product data	IEC: 1000 V / 150 A / 0.5 - 50 mm <sup>2</sup> UL: 600 V / 126 A / AWG 20 - AWG 1
Packaging	Box
Delivery status	This article will no longer be available in the future.
Last order date	2026-03-13T00:00:00+01:00

## LXXX 15.00/03/90FR 4.5SN GY BX

Weidmüller Interface GmbH & Co. KG  
Klingenbergstraße 26  
D-32758 Detmold  
Germany

www.weidmueller.com

## Technical data

## Approvals

Approvals



ROHS	Conform
UL File Number Search	<a href="#">UL Website</a>
Certificate No. (UR)	E60693

## Dimensions and weights

Depth	31 mm	Depth (inches)	1.2205 inch
Height	56 mm	Height (inches)	2.2047 inch
Height of lowest version	51.5 mm	Width	60.5 mm
Width (inches)	2.3819 inch	Net weight	92 g

## Environmental Product Compliance

RoHS Compliance Status	Compliant without exemption
REACH SVHC	No SVHC above 0.1 wt%

## System parameters

Product family	OMNIMATE Power - series LXXX	Wire connection method	Clamping yoke connection
Mounting onto the PCB	THT solder connection	Conductor outlet direction	90°
Pitch in mm (P)	15.00 mm	Pitch in inches (P)	0.591 "
Number of poles	3	Pin series quantity	1
Fitted by customer	No	Number of rows	1
Solder pin length (l)	4.5 mm	Solder pin dimensions	1.2 x 1.2 mm
Solder eyelet hole diameter (D)	1.6 mm	Solder eyelet hole diameter tolerance (D)+	0,1 mm
Number of solder pins per pole	4	Screwdriver blade	1.2 x 6.5
Screwdriver blade standard	DIN 5264	Tightening torque, min.	2.5 Nm
Tightening torque, max.	4 Nm	Clamping screw	M 6
Stripping length	18 mm	L1 in mm	30.00 mm
L1 in inches	1.181 "	Touch-safe protection acc. to DIN VDE 0470	IP 20
Protection degree	IP20		

## Material data

Insulating material	Wemid (PA)	Colour	Pebble grey
Colour chart (similar)	RAL 7032	Insulating material group	I
Comparative Tracking Index (CTI)	≥ 600	Moisture Level (MSL)	
UL 94 flammability rating	V-0	Contact material	Cu-alloy
Contact surface	tinned	Coating	4-6 µm SN
Layer structure of solder connection	1.5...3 µm Ni / 4...6 µm Sn matt	Storage temperature, min.	-40 °C
Storage temperature, max.	70 °C	Operating temperature, min.	-50 °C
Operating temperature, max.	120 °C	Temperature range, installation, min.	-25 °C
Temperature range, installation, max.	120 °C		

## Conductors suitable for connection

Clamping range, min.	0.5 mm <sup>2</sup>
Clamping range, max.	50 mm <sup>2</sup>

## LXXX 15.00/03/90FR 4.5SN GY BX

**Weidmüller Interface GmbH & Co. KG**  
 Klingenbergstraße 26  
 D-32758 Detmold  
 Germany

www.weidmueller.com

### Technical data

Wire connection cross section AWG, min.	AWG 20
Wire connection cross section AWG, max.	AWG 1
Solid, min. H05(07) V-U	0.5 mm <sup>2</sup>
Solid, max. H05(07) V-U	16 mm <sup>2</sup>
Stranded, min. H07V-R	6 mm <sup>2</sup>
Stranded, max. H07V-R	50 mm <sup>2</sup>
Flexible, min. H05(07) V-K	0.5 mm <sup>2</sup>
Flexible, max. H05(07) V-K	35 mm <sup>2</sup>
w. plastic collar ferrule, DIN 46228 pt 4, min.	0.5 mm <sup>2</sup>
w. plastic collar ferrule, DIN 46228 pt 4, max.	35 mm <sup>2</sup>
w. wire end ferrule, DIN 46228 pt 1, min.	0.5 mm <sup>2</sup>
w. wire end ferrule, DIN 46228 pt 1, max.	35 mm <sup>2</sup>

Clampable conductor	Cross-section for conductor connection	Type	fine-wired
		nominal	2.5 mm <sup>2</sup>
wire end ferrule		Stripping length	nominal 20 mm
		Recommended wire-end ferrule	<a href="#">H2.5/25D BL</a>
		Stripping length	nominal 18 mm
		Recommended wire-end ferrule	<a href="#">H2.5/18</a>
Clampable conductor	Cross-section for conductor connection	Type	fine-wired
		nominal	4 mm <sup>2</sup>
wire end ferrule		Stripping length	nominal 20 mm
		Recommended wire-end ferrule	<a href="#">H4.0/26D GR</a>
		Stripping length	nominal 18 mm
		Recommended wire-end ferrule	<a href="#">H4.0/18</a>
Clampable conductor	Cross-section for conductor connection	Type	fine-wired
		nominal	6 mm <sup>2</sup>
wire end ferrule		Stripping length	nominal 20 mm
		Recommended wire-end ferrule	<a href="#">H6.0/26 SW</a>
		Stripping length	nominal 18 mm
		Recommended wire-end ferrule	<a href="#">H6.0/18</a>
Clampable conductor	Cross-section for conductor connection	Type	fine-wired
		nominal	10 mm <sup>2</sup>
wire end ferrule		Stripping length	nominal 21 mm
		Recommended wire-end ferrule	<a href="#">H10.0/28 EB</a>
		Stripping length	nominal 18 mm
		Recommended wire-end ferrule	<a href="#">H10.0/18</a>
Clampable conductor	Cross-section for conductor connection	Type	fine-wired
		nominal	16 mm <sup>2</sup>
wire end ferrule		Stripping length	nominal 21 mm
		Recommended wire-end ferrule	<a href="#">H16.0/28 GN</a>
		Stripping length	nominal 18 mm
		Recommended wire-end ferrule	<a href="#">H16.0/18</a>
Clampable conductor	Cross-section for conductor connection	Type	fine-wired
		nominal	1.5 mm <sup>2</sup>

**LXXX 15.00/03/90FR 4.5SN GY BX**

**Weidmüller Interface GmbH & Co. KG**  
 Klingenbergstraße 26  
 D-32758 Detmold  
 Germany

www.weidmueller.com

**Technical data**

wire end ferrule	Stripping length	nominal	20 mm
	Recommended wire-end ferrule	<a href="#">H1,5/24 R</a>	
Cross-section for conductor connection	Stripping length	nominal	18 mm
	Recommended wire-end ferrule	<a href="#">H1,5/18</a>	
wire end ferrule	Type	fine-wired	
	nominal	35 mm <sup>2</sup>	
wire end ferrule	Stripping length	nominal	19 mm
	Recommended wire-end ferrule	<a href="#">H35,0/32D R</a>	
Cross-section for conductor connection	Stripping length	nominal	18 mm
	Recommended wire-end ferrule	<a href="#">H35,0/18</a>	
wire end ferrule	Type	fine-wired	
	nominal	50 mm <sup>2</sup>	
wire end ferrule	Stripping length	nominal	18 mm
	Recommended wire-end ferrule	<a href="#">H50,0/18</a>	

Reference text Length of ferrules is to be chosen depending on the product and the rated voltage., The outside diameter of the plastic collar should not be larger than the pitch (P)

**Rated data acc. to IEC**

tested acc. to standard	IEC 60664-1, IEC 61984	Rated current, min. number of poles (Tu=20°C)	150 A
Rated current, min. number of poles (Tu=40°C)	150 A	Rated voltage for surge voltage class / pollution degree II/2	1000 V
Rated voltage for surge voltage class / pollution degree III/2	1000 V	Rated voltage for surge voltage class / pollution degree III/3	1000 V
Rated impulse voltage for surge voltage class/ pollution degree II/2	8 kV	Rated impulse voltage for surge voltage class/ pollution degree III/2	8 kV
Rated impulse voltage for surge voltage class/ contamination degree III/3	8 kV		

**Rated data acc. to CSA**

Institute (CSA)	CSA	Certificate No. (CSA)	200039-1198743
Rated voltage (Use group B / CSA)	600 V	Rated voltage (Use group C / CSA)	600 V
Rated voltage (Use group D / CSA)	600 V	Rated current (Use group B / CSA)	127 A
Rated current (Use group C / CSA)	127 A	Rated current (Use group D / CSA)	5 A
Wire cross-section, AWG, min.	AWG 20	Wire cross-section, AWG, max.	AWG 1
Reference to approval values	Specifications are maximum values, details - see approval certificate.		

**Rated data acc. to UL 1059**

Institute (UR)	UR	Certificate No. (UR)	E60693
Rated voltage (Use group B / UL 1059)	600 V	Rated voltage (Use group C / UL 1059)	600 V
Rated current (Use group B / UL 1059)	126 A	Rated current (Use group C / UL 1059)	126 A
Wire cross-section, AWG, min.	AWG 20	Wire cross-section, AWG, max.	AWG 1
Reference to approval values	Specifications are maximum values, details - see approval certificate.		

**Packing**

Packaging	Box	VPE length	241.00 mm
VPE width	91.00 mm	VPE height	56.00 mm

**Technical data**

**Type tests**

Test: Durability of markings	Standard	DIN EN 60512-1-1 / 01.03		
	Test	mark of origin, type identification, type of material, pitch, date clock, approval marking CSA, approval marking UL, durability		
	Evaluation	available		
Test: Clampable cross section	Standard	DIN EN 60999-1 section 7 and 9.1 / 12.00, DIN EN 60947-1 section 8.2.4.5.1 / 12.02		
	Conductor type	Type of conductor and conductor cross-section	solid 0.5 mm <sup>2</sup>	
		Type of conductor and conductor cross-section	stranded 0.5 mm <sup>2</sup>	
		Type of conductor and conductor cross-section	solid 16 mm <sup>2</sup>	
		Type of conductor and conductor cross-section	flexible 35 mm <sup>2</sup>	
		Type of conductor and conductor cross-section	AWG 20/1	
		Type of conductor and conductor cross-section	AWG 20/19	
		Type of conductor and conductor cross-section	AWG 10/1	
		Type of conductor and conductor cross-section	AWG 1/19	
		Type of conductor and conductor cross-section	H07V-R50	
		Type of conductor and conductor cross-section	H07V-K35	
Evaluation	passed			
Test for damage to and accidental loosening of conductors	Standard	DIN EN 60999-1 section 9.5 / 12.00		
	Requirement	0.3 kg		
	Conductor type	Type of conductor and conductor cross-section	solid 0.5 mm <sup>2</sup>	
		Type of conductor and conductor cross-section	stranded 0.5 mm <sup>2</sup>	
		Type of conductor and conductor cross-section	AWG 20/1	
		Type of conductor and conductor cross-section	AWG 20/19	
	Evaluation	passed		
	Requirement	1.4 kg		
	Conductor type	Type of conductor and conductor cross-section	AWG 10/1	
	Evaluation	passed		
Requirement	2.0 kg			

**LXXX 15.00/03/90FR 4.5SN GY BX**

**Weidmüller Interface GmbH & Co. KG**  
 Klingenbergstraße 26  
 D-32758 Detmold  
 Germany

www.weidmueller.com

**Technical data**

Pull-out test	Conductor type	Type of conductor and conductor cross-section	stranded 10 mm <sup>2</sup>
	Evaluation	passed	
	Requirement	8,6 kg	
	Conductor type	Type of conductor and conductor cross-section	AWG 1/19
	Evaluation	not checked	
	Requirement	8,6 kg	
	Conductor type	Type of conductor and conductor cross-section	flexible 35 mm <sup>2</sup>
	Evaluation	passed	
	Standard	DIN EN 60999 section 8.5 / 04.94	
	Requirement	≥20 N	
	Conductor type	Type of conductor and conductor cross-section	solid 0.5 mm <sup>2</sup>
		Type of conductor and conductor cross-section	stranded 0.5 mm <sup>2</sup>
		Type of conductor and conductor cross-section	AWG 20/1
		Type of conductor and conductor cross-section	AWG 20/19
	Evaluation	passed	
	Requirement	≥80 N	
	Conductor type	Type of conductor and conductor cross-section	AWG 10/1
	Evaluation	passed	
	Requirement	≥ 90N	
	Conductor type	Type of conductor and conductor cross-section	stranded 10 mm <sup>2</sup>
Evaluation	passed		
Requirement	> 236 N		
Conductor type	Type of conductor and conductor cross-section	AWG 1/19	
Evaluation	not checked		
Requirement	> 190 N		
Conductor type	Type of conductor and conductor cross-section	flexible 35 mm <sup>2</sup>	
Evaluation	passed		

**Important note**

IPC conformity      Conformity: The products are developed, manufactured and delivered according international recognized standards and norms and comply with the assured properties in the data sheet resp. fulfill decorative properties in accordance with IPC-A-610 "Class 2". Further claims on the products can be evaluated on request.

- Notes
- Additional variants on request
  - Rated current related to rated cross-section & min. No. of poles.
  - Wire end ferrule without plastic collar to DIN 46228/1
  - Wire end ferrule with plastic collar to DIN 46228/4
  - P on drawing = pitch
  - Rated data refer only to the component itself. Clearance and creepage distances to other components are to be designed in accordance with the relevant application standards.

## LXXX 15.00/03/90FR 4.5SN GY BX

**Weidmüller Interface GmbH & Co. KG**  
Klingenbergstraße 26  
D-32758 Detmold  
Germany

[www.weidmueller.com](http://www.weidmueller.com)

## Technical data

- IP 20 from 16 mm<sup>2</sup> to 50 mm<sup>2</sup>
- The test point can only be used as potential-pickup point.
- Wire-end ferrules are mandatory for stranded wires with more than 19 strands.
- Long term storage of the product with average temperature of 50 °C and maximum humidity 70%, 36 months

### Classifications

ETIM 8.0	EC002643	ETIM 9.0	EC002643
ETIM 10.0	EC002643	ECLASS 14.0	27-46-01-01
ECLASS 15.0	27-46-01-01		

**LXXX 15.00/03/90FR 4.5SN GY BX**

Weidmüller Interface GmbH & Co. KG  
 Klingenbergstraße 26  
 D-32758 Detmold  
 Germany

www.weidmueller.com

Drawings

Product image

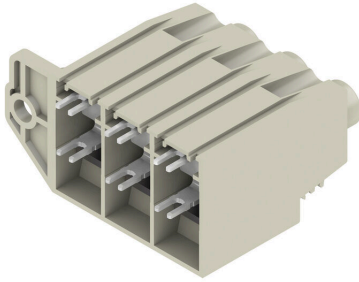

Dimensional drawing

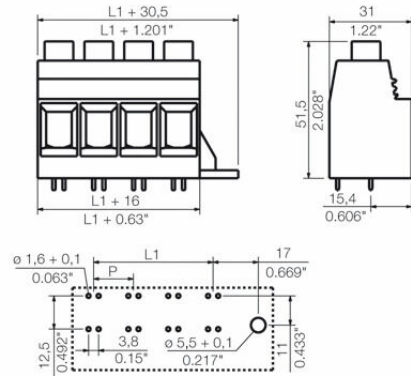

Graph

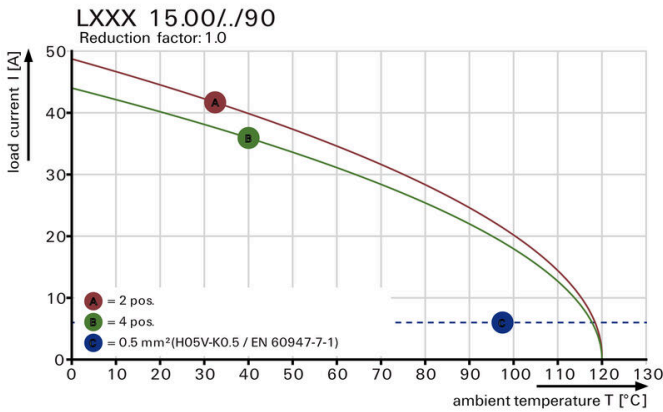

Graph

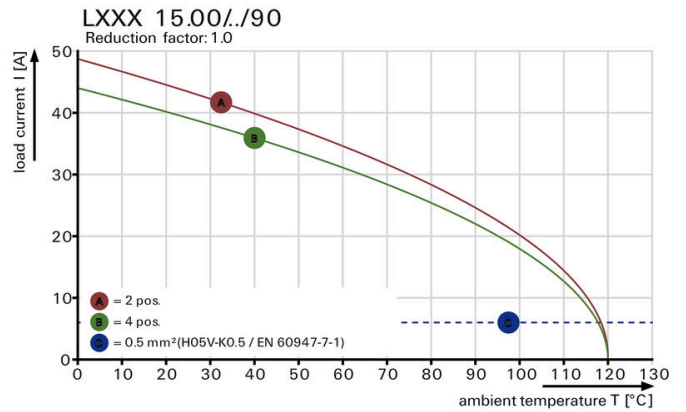

Graph

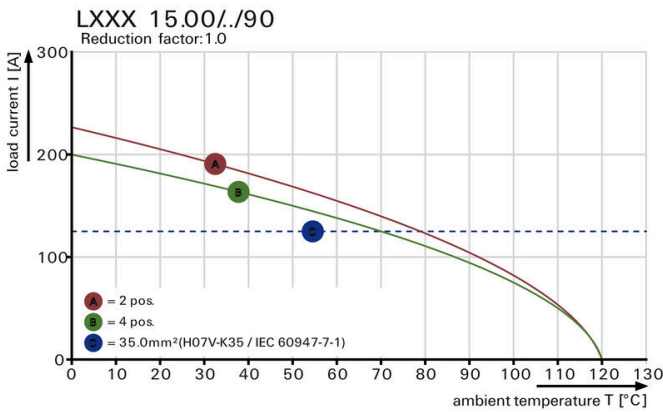

Graph

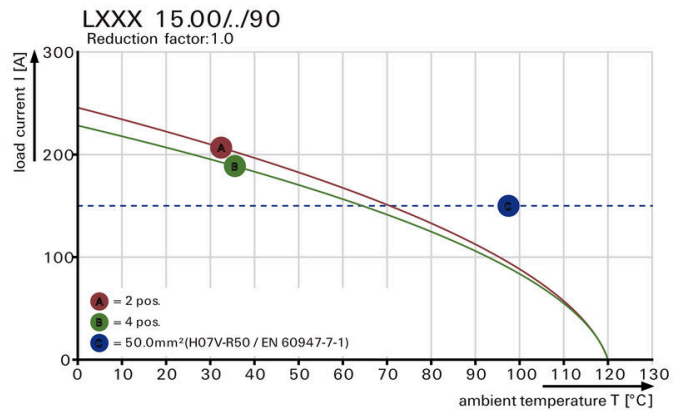

Increased power reserves Optimised application safety

Product benefits

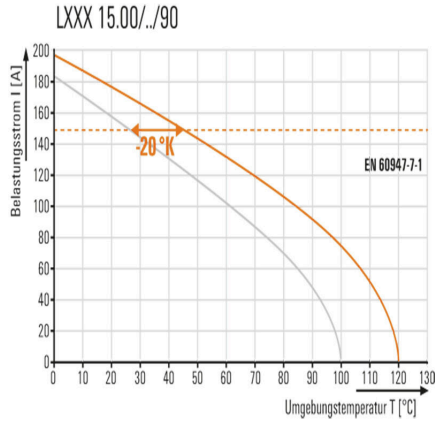

Increased power reserves Optimised application safety



Standard-compliant integration