

WDU 1.5/ZZ**Weidmüller Interface GmbH & Co. KG**

Klingenbergstraße 26

D-32758 Detmold

Germany

www.weidmueller.com

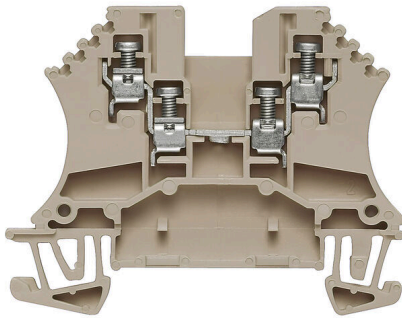
Product image

To feed through power, signal, and data is the classical requirement in electrical engineering and panel building. The insulating material, the connection system and the design of the terminal blocks are the differentiating features. A feed-through terminal block is suitable for joining and/or connecting one or more conductors. They could have one or more connection levels that are on the same potential or insulated against one another.

General ordering data

Version	Feed-through terminal block, Screw connection, dark beige, 1.5 mm ² , 17.5 A, 800 V, Number of connections: 4
Order No.	1031400000
Type	WDU 1.5/ZZ
GTIN (EAN)	4008190148546
Qty.	100 items

WDU 1.5/ZZ

Weidmüller Interface GmbH & Co. KG
 Klingenbergstraße 26
 D-32758 Detmold
 Germany

www.weidmueller.com

Technical data

Approvals

Approvals



ROHS	Conform
UL File Number Search	UL Website
Certificate No. (UR)	E60693

Dimensions and weights

Depth	46.5 mm	Depth (inches)	1.8307 inch
Height	60 mm	Height (inches)	2.3622 inch
Width	5.1 mm	Width (inches)	0.2008 inch
Net weight	8.09 g		

Temperatures

Storage temperature	-25 °C...55 °C	Ambient temperature	-60 °C...85 °C
Continuous operating temp., min.	-60 °C	Continuous operating temp., max.	130 °C

Environmental Product Compliance

RoHS Compliance Status	Compliant without exemption		
REACH SVHC	No SVHC above 0.1 wt%		
Product Carbon Footprint	Cradle to gate	0,213 kg CO2 eq.	

Material data

Basic material	Wemid	Colour	dark beige
UL 94 flammability rating	V-0		

Rating data IECEX/ATEX

Certificate No. (ATEX)	DEMKO14ATEX1338U	Certificate No. (IECEX)	IECEXULD14.0005U
Max. voltage (ATEX)	550 V	Current (ATEX)	17.5 A
Wire cross section max. (ATEX)	2.5 mm ²	Max. voltage (IECEX)	550 V
Current (IECEX)	17.5 A	Wire cross section max. (IECEX)	2.5 mm ²
Marking EN 60079-7	Ex eb II C Gb	Ex 2014/34/EU label	II 2 G D

System specifications

Version	Screw connection, Twin connection, for plug-in cross-connector, One end without connector	End cover plate required	Yes
Number of potentials	1	Number of levels	1
Number of clamping points per level	4	Number of potentials per tier	1
Levels cross-connected internally	No	PE connection	No
Mounting rail	TS 35	N-function	No
PE function	No	PEN function	No

WDU 1.5/ZZ

Weidmüller Interface GmbH & Co. KG
 Klingenbergstraße 26
 D-32758 Detmold
 Germany

www.weidmueller.com

Technical data

2 clampable conductors (H05V/H07V) with equal cross-section (rated connection)

Cross-section for connected wire, solid, two clampable wires, max.	2.5 mm ²	Cross-section for connected wire, solid, two clampable wires, min.	0.5 mm ²
Wire connection cross section, finely stranded with wire-end ferrules DIN 46228/1, 2 clampable wires, max.	0.75 mm ²	Wire connection cross section, finely stranded with wire-end ferrules DIN 46228/1, 2 clampable wires, min.	0.5 mm ²
Wire cross-section, finely stranded, two clampable wires, max.	1 mm ²	Wire connection cross section, finely stranded, two clampable wires, min.	0.5 mm ²

Additional technical data

Open sides	right	Number of similar terminals	1
Explosion-tested version	Yes	Type of mounting	Snap-on

CSA rating data

Wire cross section max. (CSA)	12 AWG	Voltage size C (CSA)	300 V
Current size C (CSA)	10 A	Certificate No. (CSA)	200039-1057876
Wire cross section min. (CSA)	26 AWG		

Conductors for clamping (additional connection)

Connection type, additional connection Screw connection

Conductors for clamping (rated connection)

Gauge to IEC 60947-1	A1
Wire connection cross section AWG, max.	AWG 14
Connection direction	on side
Tightening torque, max.	0.6 Nm
Tightening torque, min.	0.4 Nm
Stripping length	7 mm
Type of connection	Screw connection
Number of connections	4
Clamping range, max.	2.5 mm ²
Clamping range, min.	0.13 mm ²
Clamping screw	M 2.5
Blade size	0.6 x 3.5 mm
Wire connection cross section AWG, min.	AWG 26
Wire connection cross-section, finely stranded with wire-end ferrules DIN 46228/4, max.	1.5 mm ²
Wire connection cross-section, finely stranded with wire-end ferrules DIN 46228/4, min.	0.5 mm ²
Wire connection cross-section, finely stranded with wire-end ferrules DIN 46228/1, max.	1.5 mm ²
Wire connection cross-section, finely stranded with wire-end ferrules DIN 46228/1, min.	0.5 mm ²
Wire connection cross section, finely stranded, max.	1.5 mm ²
Wire connection cross section, finely stranded, min.	0.5 mm ²
Connection cross-section, stranded, max.	2.5 mm ²

WDU 1.5/ZZ

Weidmüller Interface GmbH & Co. KG
 Klingenbergstraße 26
 D-32758 Detmold
 Germany

www.weidmueller.com

Technical data

Connection cross-section, stranded, min. 0.5 mm ²				
Torque level with DMS electric screwdriver	1			
Wire connection cross-section, solid core, max.	2.5 mm ²			
Wire connection cross-section, solid core, min.	0.5 mm ²			
Clampable conductor	Connection specification		Screw connection	
	Cross-section for conductor connection	Type	solid, H05(07) V-U	
		min.	0.5 mm ²	
		max.	2.5 mm ²	
		nominal	1.5 mm ²	
	wire end ferrule	Stripping length	min.	7 mm
			max.	7 mm
			nominal	7 mm
		Tightening torque	min.	0.4 Nm
			max.	0.6 Nm
	Connection specification		Screw connection	
Cross-section for conductor connection	Type	stranded, H07V-R		
	min.	0.5 mm ²		
	max.	2.5 mm ²		
	nominal	1.5 mm ²		
wire end ferrule	Stripping length	min.	7 mm	
		max.	7 mm	
		nominal	7 mm	
	Tightening torque	min.	0.4 Nm	
		max.	0.6 Nm	
Connection specification		Screw connection		
Cross-section for conductor connection	Type	flexible, H05(07) V-K		
	min.	0.5 mm ²		
	max.	1.5 mm ²		
	nominal	1.5 mm ²		
wire end ferrule	Stripping length	min.	7 mm	
		max.	7 mm	
		nominal	7 mm	
	Tightening torque	min.	0.4 Nm	
		max.	0.6 Nm	

General

Wire connection cross section AWG, max.	AWG 14	Wire connection cross section AWG, min.	AWG 26
Standards	IEC 60947-7-1	Mounting rail	TS 35

Rating data

Rated cross-section	1.5 mm ²	Rated voltage	800 V
Rated DC voltage	800 V	Nominal current	17.5 A
Current at maximum wires	23 A	Standards	IEC 60947-7-1
Volume resistance according to IEC 60947-7-x	1.83 mΩ	Rated impulse withstand voltage	8 kV
Power loss in accordance with IEC 60947-7-x	0.56 W	Pollution severity	3

UL rating data

Conductor size Factory wiring max. (UR)	12 AWG	Current size C (UR)	25 A
Voltage size C (UR)	300 V	Conductor size Factory wiring min. (UR)	26 AWG

Technical data

Certificate No. (UR)	E60693	Conductor size Field wiring min. (UR)	22 AWG
Conductor size Field wiring max. (UR)	12 AWG		

Classifications

ETIM 8.0	EC000897	ETIM 9.0	EC000897
ETIM 10.0	EC000897	ECLASS 14.0	27-25-01-01
ECLASS 15.0	27-25-01-01		

Drawings

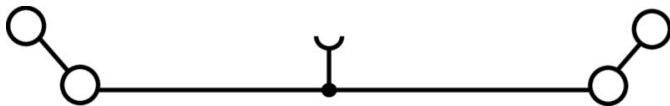

WDU 1.5/ZZ

Weidmüller Interface GmbH & Co. KG
 Klingenbergstraße 26
 D-32758 Detmold
 Germany

Accessories

www.weidmueller.com

Cross-connections



The distribution or multiplication of a potential to adjoining terminal blocks is realized via a cross-connection. Additional wiring effort can be easily avoided. Even if the poles are broken out, contact reliability in the terminal blocks is still ensured. Our portfolio offers pluggable and screwable cross-connection systems for modular terminal blocks.

General ordering data

Type	ZQV 2.5N/2 GE	Version
Order No.	1693800000	W-Series, Cross-connector, 24 A
GTIN (EAN)	4008190883621	
Qty.	60 ST	
Type	ZQV 2.5N/3 GE	Version
Order No.	1693810000	W-Series, Cross-connector, 24 A
GTIN (EAN)	4008190883645	
Qty.	60 ST	
Type	ZQV 2.5N/4 GE	Version
Order No.	1693820000	W-Series, Cross-connector, 24 A
GTIN (EAN)	4008190883652	
Qty.	60 ST	
Type	ZQV 2.5N/10 GE	Version
Order No.	1693880000	W-Series, Cross-connector, 24 A
GTIN (EAN)	4008190883720	
Qty.	20 ST	
Type	ZQV 2.5N/20 GE	Version
Order No.	1909000000	W-Series, Cross-connector, 24 A
GTIN (EAN)	4032248535613	
Qty.	20 ST	
Type	WQV 2.5/2	Version
Order No.	1053660000	Cross-connector (terminal), when screwed in, yellow, 32 A, Number of
GTIN (EAN)	4008190031121	poles: 2, Pitch in mm (P): 5.10, Insulated: Yes, Width: 7 mm
Qty.	50 ST	
Type	WQV 2.5/3	Version
Order No.	1053760000	Cross-connector (terminal), when screwed in, yellow, 32 A, Number of
GTIN (EAN)	4008190058999	poles: 3, Pitch in mm (P): 5.10, Insulated: Yes, Width: 7 mm
Qty.	50 ST	
Type	WQV 2.5/4	Version
Order No.	1053860000	Cross-connector (terminal), when screwed in, yellow, 32 A, Number of
GTIN (EAN)	4008190049706	poles: 4, Pitch in mm (P): 5.10, Insulated: Yes, Width: 7 mm
Qty.	50 ST	
Type	WQV 2.5/10	Version
Order No.	1054460000	Cross-connector (terminal), when screwed in, yellow, 32 A, Number of
GTIN (EAN)	4008190135089	poles: 10, Pitch in mm (P): 5.10, Insulated: Yes, Width: 7 mm
Qty.	20 ST	

WDU 1.5/ZZ

Weidmüller Interface GmbH & Co. KG
Klingenbergstraße 26
D-32758 Detmold
Germany

www.weidmueller.com

Accessories

End plates and partition plates



Partition plates and end plates are essential accessories for terminal blocks. Partition plates provide optical and electrical separation of different potentials and functional groups, increasing safety and ensuring a clear structure inside the control cabinet. End plates close the terminal block row on the sides, protect against contact with live parts, and ensure a clean, stable finish. Both components are precisely matched to the respective Weidmüller terminal block series, contributing to safe, compliant, and professional wiring.

General ordering data

Type	WAP 2.5-10	Version
Order No.	1050000000	End plate for terminals, dark beige, Height: 56 mm, Width: 1.5 mm,
GTIN (EAN)	4008190103149	V-0, Wemid, Snap-on: No
Qty.	50 ST	
Type	WAP 2.5-10 BL	Version
Order No.	1050080000	End plate for terminals, blue, Height: 56 mm, Width: 1.5 mm, V-0,
GTIN (EAN)	4008190136611	Wemid, Snap-on: No
Qty.	50 ST	
Type	WAP 16+35 WTW 2.5-10	Version
Order No.	1050100000	End and partition plate for terminals, dark beige, Height: 56 mm,
GTIN (EAN)	4008190079901	Width: 1.5 mm, V-0, Wemid
Qty.	20 ST	
Type	WAP 16+35 WTW 2.5-10 BL	Version
Order No.	1050180000	End and partition plate for terminals, blue, Height: 56 mm, Width: 1.5
GTIN (EAN)	4008190013899	mm, V-0, Wemid
Qty.	20 ST	

End bracket

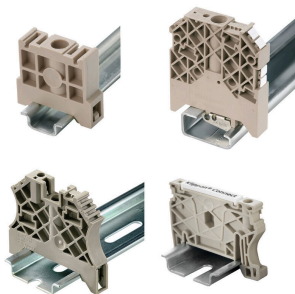

Weidmüller's range of products includes end brackets that guarantee a permanent, reliable mounting on the terminal rail and prevent sliding. Versions with and without screws are available. The end brackets include marking options, also for group markers, and also a test plug holder.

General ordering data

Type	WEW 35/2	Version
Order No.	1061200000	End bracket, dark beige, TS 35, HB, Wemid, Width: 8 mm, 100 °C
GTIN (EAN)	4008190030230	
Qty.	50 ST	

WDU 1.5/ZZ

Weidmüller Interface GmbH & Co. KG
 Klingenbergstraße 26
 D-32758 Detmold
 Germany

www.weidmueller.com

Accessories

Testadapter and testsockets



Test adapters and test plugs are used for the electrical connection between terminal blocks and the test equipment. In this way, an electrical contact can be established in the wired state and measurements can be done easily.

General ordering data

Type	WTA 2 WDU2.5-10	Version
Order No.	1632320000	Test adapter (terminal), 1.5 mm ² , 250 V, 6 A
GTIN (EAN)	4008190257347	
Qty.	25 ST	
Type	WTA 2/ZA WDU2.5-10	Version
Order No.	1632330000	Test adapter (terminal), 1.5 mm ² , 250 V, 6 A
GTIN (EAN)	4008190257330	
Qty.	25 ST	

Warning cover



Warning covers with a flash symbol provide more safety for man and machine. They are used where external voltage must be indicated within the application.

General ordering data

Type	WAD 4 GE BED	Version
Order No.	1072000000	Terminal cover, yellow, PA 66, Height: 19.8 mm, Width: 4.5 mm, Depth: 9.6 mm, V-2
GTIN (EAN)	4008190446109	
Qty.	50 ST	
Type	WAD 4 WS	Version
Order No.	1072100000	Terminal cover, white, PA 66, Height: 19.8 mm, Width: 4.5 mm, Depth: 9.6 mm, V-2
GTIN (EAN)	4008190446116	
Qty.	50 ST	

Blank



The Dekafix (DEK) marker is the universal marker for all conductor and plug-in connectors as well as for electronic sub-assemblies. The system is ideal for short number sequences and covers a wide range of ready-printed markers.

Strips for fast installation in only one work step. The printing is easy to read, rich in contrast and available in various widths.

- Large range of ready-to-use markers
 - Strips for fast installation
 - Terminal markers, suitable for all Weidmüller cable connectors
 - Available as blank MultiCard or with standard printing
- For custom printing: Please send us a file of our labeling software M-Print PRO or M-Print PRO Online (without installation) for your labeling specifications.

General ordering data

Type	DEK 5/5 MC NE WS	Version
Order No.	1609801044	Dekafix, Terminal marker, 5 x 5 mm, Pitch in mm (P): 5.00
GTIN (EAN)	4008190397111	Weidmueller, white
Qty.	1000 ST	
Type	WS 12/5 MC NE WS	Version
Order No.	1609860000	WS, Terminal marker, 12 x 5 mm, Pitch in mm (P): 5.00 Weidmueller,
GTIN (EAN)	4008190203481	Allen-Bradley, white
Qty.	720 ST	

SchT group marker carrier

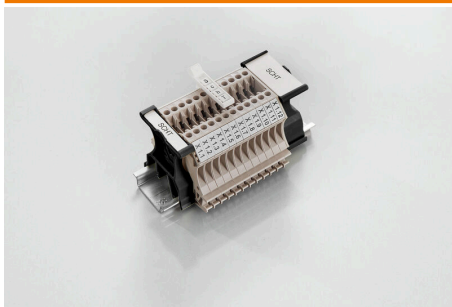

The SchT 5 S group tag carriers are clipped directly onto the TS 32 mounting rail (G-rail) or the TS 35 mounting rail (top-hat rail). It is therefore possible to label the terminal strip irrespective of the terminal and the type of terminal. SchT 5 and SchT 5 S are fitted with ESO 5, STR 5 protective strips.

The SchT 7 is a hinged group tag carrier for inlay tags which enables easy access to the clamping screw. The SchT 7 is fitted with ESO 7, STR 7 protective strips or DEK 5.

Inlay tags and protective strips can be found under "Accessories".

General ordering data

Type	SCHT 7	Version
Order No.	0517960000	SCHT, Terminal marker, 39.3 x 8 mm, Pitch in mm (P): 7.00
GTIN (EAN)	4008190001742	Weidmueller, white
Qty.	20 ST	

WDU 1.5/ZZ

Weidmüller Interface GmbH & Co. KG
 Klingenbergstraße 26
 D-32758 Detmold
 Germany

www.weidmueller.com

Accessories

ZGB pivotable group tag holder



The ZGB 15 is a hinged group tag carrier. The tag carrier can hold the dekafix 5, WS 12/5 terminal markers or the inlay tag ESO 15.

The ZGB 30 is a hinged group tag carrier. The tag carrier can hold the dekafix 5, WS 12/5 terminal markers or the inlay tag ESO 7.

Inlay tags and protective strips can be found under "Accessories".

General ordering data

Type	ZGB 15	Version	
Order No.	1636530000	Terminal markers, Terminal marker, 15 x 7 mm, Pitch in mm (P): 5.00	
GTIN (EAN)	4008190297053	Weidmueller, white	
Qty.	20 ST		
Type	ZGB 30	Version	
Order No.	1611930000	Terminal markers, Terminal marker, 32 x 7 mm, Pitch in mm (P): 5.00	
GTIN (EAN)	4008190002251	Weidmueller, white	
Qty.	20 ST		

Shield clamping saddle



With our wide range of KLBÜ shield connections, you can achieve flexible and self-adjusting shield contacting and ensure error-free plant operation.

General ordering data

Type	LS 2.8 WDU2.5-10	Version	
Order No.	1056400000	W-Series, Shield bus	
GTIN (EAN)	4008190036454		
Qty.	100 ST		

End plates and partition plates



Partition plates and end plates are essential accessories for terminal blocks. Partition plates provide optical and electrical separation of different potentials and functional groups, increasing safety and ensuring a clear structure inside the control cabinet. End plates close the terminal block row on the sides, protect against contact with live parts, and ensure a clean, stable finish. Both components are precisely matched to the respective Weidmüller terminal block series, contributing to safe, compliant, and professional wiring.

WDU 1.5/ZZ

Weidmüller Interface GmbH & Co. KG
 Klingenbergstraße 26
 D-32758 Detmold
 Germany

www.weidmueller.com

Accessories

General ordering data

Type	WTW EN	Version
Order No.	1058800000	Partition plate (terminal), dark beige, Height: 86 mm, Width: 3 mm,
GTIN (EAN)	4008190140175	V-0, Wemid
Qty.	20 ST	

Cross-connections

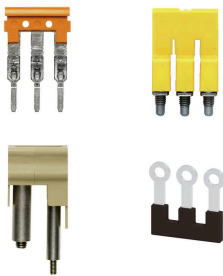

The distribution or multiplication of a potential to adjoining terminal blocks is realized via a cross-connection. Additional wiring effort can be easily avoided. Even if the poles are broken out, contact reliability in the terminal blocks is still ensured. Our portfolio offers pluggable and screwable cross-connection systems for modular terminal blocks.

General ordering data

Type	WQB B/10	Version
Order No.	1579050000	Cross-connector (terminal), when screwed in, black, 24 A, Number of
GTIN (EAN)	4008190094508	poles: 10, Pitch in mm (P): 5.10, Insulated: Yes, Width: 48.26 mm
Qty.	20 ST	
Type	WQB B/2	Version
Order No.	1579010000	Cross-connector (terminal), when screwed in, black, 24 A, Number of
GTIN (EAN)	4008190021696	poles: 2, Pitch in mm (P): 5.10, Insulated: Yes, Width: 10.14 mm
Qty.	50 ST	
Type	WQB B/24	Version
Order No.	1579060000	Cross-connector (terminal), when screwed in, black, 24 A, Number of
GTIN (EAN)	4008190188597	poles: 24, Pitch in mm (P): 5.10, Insulated: Yes, Width: 123.22 mm
Qty.	20 ST	
Type	WQB B/3	Version
Order No.	1579020000	Cross-connector (terminal), when screwed in, black, 24 A, Number of
GTIN (EAN)	4008190062392	poles: 3, Pitch in mm (P): 5.10, Insulated: Yes, Width: 15.28 mm
Qty.	50 ST	
Type	WQB B/4	Version
Order No.	1579030000	Cross-connector (terminal), when screwed in, black, 24 A, Number of
GTIN (EAN)	4008190185046	poles: 4, Pitch in mm (P): 5.10, Insulated: Yes, Width: 20.42 mm
Qty.	50 ST	
Type	WQB B/6	Version
Order No.	1579040000	Cross-connector (terminal), when screwed in, black, 24 A, Number of
GTIN (EAN)	4008190081041	poles: 6, Pitch in mm (P): 5.10, Insulated: Yes, Width: 30.7 mm
Qty.	20 ST	
Type	ZQV 2.5N/20 RT	Version
Order No.	1909110000	W-Series, Cross-connector, For the terminals, Number of poles: 20
GTIN (EAN)	4032248535781	
Qty.	20 ST	

WDU 1.5/ZZ

Weidmüller Interface GmbH & Co. KG
 Klingenbergstraße 26
 D-32758 Detmold
 Germany

www.weidmueller.com

Accessories

Testadapter and testsockets



Test adapters and test plugs are used for the electrical connection between terminal blocks and the test equipment. In this way, an electrical contact can be established in the wired state and measurements can be done easily.

General ordering data

Type	STB 8.5/D4/2.3/M2.5 AKZ	Version	
Order No.	0215700000	Accessories, Socket	
GTIN (EAN)	4008190184872		
Qty.	50 ST		

Marker holder

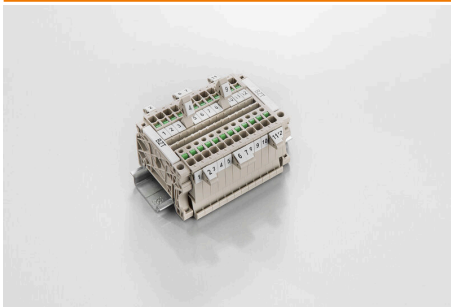

The marker holder offer the possibility of additional mounting of standard markers with a pitch of 5 or 5.1 mm. The angled holders can be optionally snapped together and could be mounted in all standard marking channels of the Klippon® Connect modular terminal blocks. Fitting marker types could be found under the respective accessories of the designation marking holder.

General ordering data

Type	BZT 1 WS 10/5	Version	
Order No.	1805490000	Accessories, Marker holder	
GTIN (EAN)	4032248270231		
Qty.	100 ST		
Type	BZT 1 ZA WS 10/5	Version	
Order No.	1805520000	Accessories, Marker holder	
GTIN (EAN)	4032248270248		
Qty.	100 ST		

WDU 1.5/ZZ

Weidmüller Interface GmbH & Co. KG
 Klingenbergstraße 26
 D-32758 Detmold
 Germany

www.weidmueller.com

Accessories

WS 12/5



WS/ DEK

MultiMark terminal markers use an innovative composite material made from two components. The hard base contour of the marker snaps securely into the connector. The elastic surface finish makes the marker easy to mount. This specially punched material enables the strips to be stretched to accommodate the slight variations in spacing that tend to add up, especially with long terminal blocks. Another advantage: the excellent printability of the surface material guarantees durable and wear-resistant labelling. A print resolution of 300 dpi also produces a very legible script.

Your benefits with MultiMark

- Firm hold and durable printing
- Continuous strips save installation time
- Easy mounting thanks to an innovative composite material
- Large label field for optimal legibility
- High flexibility thanks to manufacturer independence

General ordering data

Type	WS 12/5 MM WS	Version	
Order No.	2007190000	WS, Terminal marker, 12 x 5 mm, Weidmueller, white	
GTIN (EAN)	4050118392036		
Qty.	800 ST		

Cross-connections

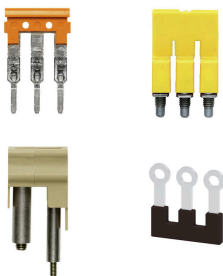

The distribution or multiplication of a potential to adjoining terminal blocks is realized via a cross-connection. Additional wiring effort can be easily avoided. Even if the poles are broken out, contact reliability in the terminal blocks is still ensured. Our portfolio offers pluggable and screwable cross-connection systems for modular terminal blocks.

General ordering data

Type	ZQV 2.5N/9 RD	Version	
Order No.	2108900000	Cross-connector (terminal), Plugged, red, 24 A, Number of poles: 9,	
GTIN (EAN)	4050118448474	Pitch in mm (P): 5.10, Insulated: Yes, Width: 43.6 mm	
Qty.	20 ST		
Type	ZQV 2.5N/9 BL	Version	
Order No.	1527870000	Cross-connector (terminal), Plugged, blue, 24 A, Number of poles: 9,	
GTIN (EAN)	4050118448580	Pitch in mm (P): 5.10, Insulated: Yes, Width: 43.6 mm	
Qty.	20 ST		
Type	ZQV 2.5N/9	Version	
Order No.	1527680000	Cross-connector (terminal), Plugged, orange, 24 A, Number of poles:	
GTIN (EAN)	4050118447996	9, Pitch in mm (P): 5.10, Insulated: Yes, Width: 43.6 mm	
Qty.	20 ST		

WDU 1.5/ZZ

Weidmüller Interface GmbH & Co. KG
 Klingenbergstraße 26
 D-32758 Detmold
 Germany

www.weidmueller.com

Accessories

Type	ZQV 2.5N/8 RD	Version
Order No.	2108870000	Cross-connector (terminal), Plugged, red, 24 A, Number of poles: 8,
GTIN (EAN)	4050118448481	Pitch in mm (P): 5.10, Insulated: Yes, Width: 38.5 mm
Qty.	20 ST	
Type	ZQV 2.5N/8 BL	Version
Order No.	1527840000	Cross-connector (terminal), Plugged, blue, 24 A, Number of poles: 8,
GTIN (EAN)	4050118448597	Pitch in mm (P): 5.10, Insulated: Yes, Width: 38.5 mm
Qty.	20 ST	
Type	ZQV 2.5N/8	Version
Order No.	1527670000	Cross-connector (terminal), Plugged, orange, 24 A, Number of poles: 8,
GTIN (EAN)	4050118448405	Pitch in mm (P): 5.10, Insulated: Yes, Width: 38.5 mm
Qty.	20 ST	
Type	ZQV 2.5N/7 RD	Version
Order No.	2108810000	Cross-connector (terminal), Plugged, red, 24 A, Number of poles: 7,
GTIN (EAN)	4050118448498	Pitch in mm (P): 5.10, Insulated: Yes, Width: 33.4 mm
Qty.	20 ST	
Type	ZQV 2.5N/7 BL	Version
Order No.	1527830000	Cross-connector (terminal), Plugged, blue, 24 A, Number of poles: 7,
GTIN (EAN)	4050118448603	Pitch in mm (P): 5.10, Insulated: Yes, Width: 33.4 mm
Qty.	20 ST	
Type	ZQV 2.5N/7	Version
Order No.	1527640000	Cross-connector (terminal), Plugged, orange, 24 A, Number of poles: 7,
GTIN (EAN)	4050118448412	Pitch in mm (P): 5.10, Insulated: Yes, Width: 33.4 mm
Qty.	20 ST	
Type	ZQV 2.5N/6 RD	Version
Order No.	2108720000	Cross-connector (terminal), Plugged, red, 24 A, Number of poles: 6,
GTIN (EAN)	4050118448504	Pitch in mm (P): 5.10, Insulated: Yes, Width: 28.3 mm
Qty.	20 ST	
Type	ZQV 2.5N/6 BL	Version
Order No.	1527820000	Cross-connector (terminal), Plugged, blue, 24 A, Number of poles: 6,
GTIN (EAN)	4050118448610	Pitch in mm (P): 5.10, Insulated: Yes, Width: 28.3 mm
Qty.	20 ST	
Type	ZQV 2.5N/6	Version
Order No.	1527630000	Cross-connector (terminal), Plugged, orange, 24 A, Number of poles: 6,
GTIN (EAN)	4050118448429	Pitch in mm (P): 5.10, Insulated: Yes, Width: 28.3 mm
Qty.	20 ST	
Type	ZQV 2.5N/50 RD	Version
Order No.	2109000000	Cross-connector (terminal), Plugged, red, 24 A, Number of poles: 50,
GTIN (EAN)	4050118486001	Pitch in mm (P): 5.10, Insulated: Yes, Width: 255 mm
Qty.	5 ST	
Type	ZQV 2.5N/50 BL	Version
Order No.	1527920000	Cross-connector (terminal), Plugged, blue, 24 A, Number of poles: 50,
GTIN (EAN)	4050118448559	Pitch in mm (P): 5.10, Insulated: Yes, Width: 255 mm
Qty.	5 ST	
Type	ZQV 2.5N/50	Version
Order No.	1527730000	Cross-connector (terminal), Plugged, orange, 24 A, Number of poles: 50,
GTIN (EAN)	4050118411362	Pitch in mm (P): 5.10, Insulated: Yes, Width: 255 mm
Qty.	5 ST	
Type	ZQV 2.5N/5 RD	Version
Order No.	2108710000	Cross-connector (terminal), Plugged, red, 24 A, Number of poles: 5,
GTIN (EAN)	4050118448511	Pitch in mm (P): 5.10, Insulated: Yes, Width: 23.2 mm
Qty.	20 ST	

WDU 1.5/ZZ

Weidmüller Interface GmbH & Co. KG
 Klingenbergstraße 26
 D-32758 Detmold
 Germany

www.weidmueller.com

Accessories

Type	ZQV 2.5N/5 BL	Version
Order No.	1527790000	Cross-connector (terminal), Plugged, blue, 24 A, Number of poles: 5,
GTIN (EAN)	4050118448627	Pitch in mm (P): 5.10, Insulated: Yes, Width: 23.2 mm
Qty.	20 ST	
Type	ZQV 2.5N/5	Version
Order No.	1527620000	Cross-connector (terminal), Plugged, orange, 24 A, Number of poles:
GTIN (EAN)	4050118448436	5, Pitch in mm (P): 5.10, Insulated: Yes, Width: 23.2 mm
Qty.	20 ST	
Type	ZQV 2.5N/4 RD	Version
Order No.	2108700000	Cross-connector (terminal), Plugged, red, 24 A, Number of poles: 4,
GTIN (EAN)	4050118448528	Pitch in mm (P): 5.10, Insulated: Yes, Width: 18.1 mm
Qty.	60 ST	
Type	ZQV 2.5N/4 BL	Version
Order No.	1527780000	Cross-connector (terminal), Plugged, blue, 24 A, Number of poles: 4,
GTIN (EAN)	4050118448634	Pitch in mm (P): 5.10, Insulated: Yes, Width: 18.1 mm
Qty.	60 ST	
Type	ZQV 2.5N/4	Version
Order No.	1527590000	Cross-connector (terminal), Plugged, orange, 24 A, Number of poles:
GTIN (EAN)	4050118448443	4, Pitch in mm (P): 5.10, Insulated: Yes, Width: 18.1 mm
Qty.	60 ST	
Type	ZQV 2.5N/3 RD	Version
Order No.	2108690000	Cross-connector (terminal), Plugged, red, 24 A, Number of poles: 3,
GTIN (EAN)	4050118448535	Pitch in mm (P): 5.10, Insulated: Yes, Width: 13 mm
Qty.	60 ST	
Type	ZQV 2.5N/3 BL	Version
Order No.	1527770000	Cross-connector (terminal), Plugged, blue, 24 A, Number of poles: 3,
GTIN (EAN)	4050118448641	Pitch in mm (P): 5.10, Insulated: Yes, Width: 13 mm
Qty.	60 ST	
Type	ZQV 2.5N/3	Version
Order No.	1527570000	Cross-connector (terminal), Plugged, orange, 24 A, Number of poles:
GTIN (EAN)	4050118448450	3, Pitch in mm (P): 5.10, Insulated: Yes, Width: 13 mm
Qty.	60 ST	
Type	ZQV 2.5N/20 RD	Version
Order No.	2108920000	Cross-connector (terminal), Plugged, red, 24 A, Number of poles: 20,
GTIN (EAN)	4050118448589	Pitch in mm (P): 5.10, Insulated: Yes, Width: 102 mm
Qty.	20 ST	
Type	ZQV 2.5N/20 BL	Version
Order No.	1527890000	Cross-connector (terminal), Plugged, blue, 24 A, Number of poles: 20,
GTIN (EAN)	4050118448566	Pitch in mm (P): 5.10, Insulated: Yes, Width: 102 mm
Qty.	20 ST	
Type	ZQV 2.5N/20	Version
Order No.	1527720000	Cross-connector (terminal), Plugged, orange, 24 A, Number of poles:
GTIN (EAN)	4050118447972	20, Pitch in mm (P): 5.10, Insulated: Yes, Width: 102 mm
Qty.	20 ST	
Type	ZQV 2.5N/2 RD	Version
Order No.	2108470000	Cross-connector (terminal), Plugged, red, 24 A, Number of poles: 2,
GTIN (EAN)	4050118448542	Pitch in mm (P): 5.10, Insulated: Yes, Width: 7.9 mm
Qty.	60 ST	
Type	ZQV 2.5N/2 BL	Version
Order No.	1527740000	Cross-connector (terminal), Plugged, blue, 24 A, Number of poles: 2,
GTIN (EAN)	4050118448658	Pitch in mm (P): 5.10, Insulated: Yes, Width: 7.9 mm
Qty.	60 ST	

WDU 1.5/ZZ

Weidmüller Interface GmbH & Co. KG
 Klingenbergstraße 26
 D-32758 Detmold
 Germany

www.weidmueller.com

Accessories

Type	ZQV 2.5N/2	Version
Order No.	1527540000	Cross-connector (terminal), Plugged, orange, 24 A, Number of poles:
GTIN (EAN)	4050118448467	2, Pitch in mm (P): 5.10, Insulated: Yes, Width: 7.9 mm
Qty.	60 ST	
Type	ZQV 2.5N/10 RD	Version
Order No.	2108910000	Cross-connector (terminal), Plugged, red, 24 A, Number of poles: 10,
GTIN (EAN)	40501184486018	Pitch in mm (P): 5.10, Insulated: Yes, Width: 48.7 mm
Qty.	20 ST	
Type	ZQV 2.5N/10 BL	Version
Order No.	1527880000	Cross-connector (terminal), Plugged, blue, 24 A, Number of poles: 10,
GTIN (EAN)	4050118448573	Pitch in mm (P): 5.10, Insulated: Yes, Width: 48.7 mm
Qty.	20 ST	
Type	ZQV 2.5N/10	Version
Order No.	1527690000	Cross-connector (terminal), Plugged, orange, 24 A, Number of poles:
GTIN (EAN)	4050118447989	10, Pitch in mm (P): 5.10, Insulated: Yes, Width: 48.7 mm
Qty.	20 ST	