

BLF 5.00HC/06/180 SN OR BX

Weidmüller Interface GmbH & Co. KG
 Klingenbergstraße 26
 D-32758 Detmold
 Germany

www.weidmueller.com

Product image

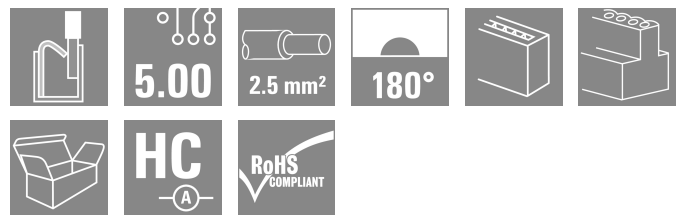
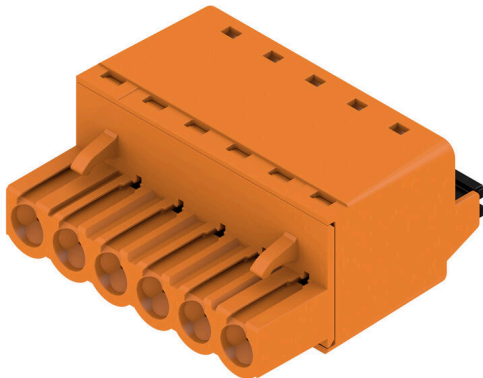

Just as reliable as the millionfold proven original and featuring innovative details:

The BLF 5.00HC PUSH IN version of the BLZ 5.00HC female connector features a new connection system and a more compact design. Weidmüller's innovative PUSH IN spring connection system stands for the future of easy and tool-free wire connection. HC = High Current. In terms of versatility, the BLF 5.00HC offers just as much as the older versions:

- 3 tested-and-proven wire outlet directions provide the usual flexibility for application-specific design
- 4 flange variations and the patented release latch allow the locking concept to be based on the requirements of the user

General ordering data

Version	PCB plug-in connector, female plug, 5.00 mm, Number of poles: 6, 180°, PUSH IN with actuator, Clamping range, max.: 3.31 mm², Box
Order No.	1017910000
Type	BLF 5.00HC/06/180 SN OR BX
GTIN (EAN)	4032248728633
Qty.	60 items
Product data	IEC: 400 V / 23 A / 0.2 - 2.5 mm² UL: 300 V / 18.5 A / AWG 26 - AWG 12
Packaging	Box

BLF 5.00HC/06/180 SN OR BX

Weidmüller Interface GmbH & Co. KG

Klingenbergstraße 26

D-32758 Detmold

Germany

www.weidmueller.com

Technical data

Approvals

Approvals



ROHS Conform

UL File Number Search [UL Website](#)

Certificate No. (cURus) E60693

Dimensions and weights

Depth	27.6 mm	Depth (inches)	1.0866 inch
Height	14.2 mm	Height (inches)	0.5591 inch
Width	30 mm	Width (inches)	1.1811 inch
Net weight	11.23 g		

Environmental Product Compliance

RoHS Compliance Status	Compliant without exemption		
REACH SVHC	No SVHC above 0.1 wt%		
Product Carbon Footprint	Cradle to gate	0,95 kg CO2 eq.	

System Parameters

Product family	OMNIMATE Signal - series BL/SL 5.00	Type of connection	Field connection
Wire connection method	PUSH IN with actuator	Pitch in mm (P)	5.00 mm
Pitch in inches (P)	0.197 "	Conductor outlet direction	180°
Number of poles	6	L1 in mm	25.00 mm
L1 in inches	0.985 "	Number of rows	1
Pin series quantity	1	Rated cross-section	2.5 mm ²
Touch-safe protection acc. to DIN VDE 57 106	Safe from back-of-hand touch	Touch-safe protection acc. to DIN VDE 0470	IP20 plugged/ IP10 unplugged
Protection degree	IP20	Volume resistance	≤5 mΩ
Can be coded	Yes	Stripping length	10 mm
Screwdriver blade	0.6 x 3.5	Screwdriver blade standard	DIN 5264
Plugging cycles	25	Plugging force/pole, max.	7 N
Pulling force/pole, max.	5.5 N		

Material data

Insulating material	PBT	Colour	orange
Colour of operational elements	black	Colour chart (similar)	RAL 2000
Insulating material group	IIIa	Comparative Tracking Index (CTI)	≥ 200
Moisture Level (MSL)		UL 94 flammability rating	V-0
Contact material	Cu-alloy	Contact surface	tinned
Layer structure of plug contact	4...8 μm Sn hot-dip tinned	Storage temperature, min.	-40 °C
Storage temperature, max.	70 °C	Operating temperature, min.	-50 °C
Operating temperature, max.	100 °C	Temperature range, installation, min.	-30 °C
Temperature range, installation, max.	100 °C		

Conductors suitable for connection

Clamping range, min.	0.13 mm ²
Clamping range, max.	3.31 mm ²

BLF 5.00HC/06/180 SN OR BX

Weidmüller Interface GmbH & Co. KG
 Klingenbergstraße 26
 D-32758 Detmold
 Germany

www.weidmueller.com

Technical data

Wire connection cross section AWG, min.	AWG 26			
Wire connection cross section AWG, max.	AWG 12			
Solid, min. H05(07) V-U	0.2 mm ²			
Solid, max. H05(07) V-U	2.5 mm ²			
Flexible, min. H05(07) V-K	0.2 mm ²			
Flexible, max. H05(07) V-K	2.5 mm ²			
w. plastic collar ferrule, DIN 46228 pt 4, max.	2.5 mm ²			
w. wire end ferrule, DIN 46228 pt 1, min.	0.25 mm ²			
w. wire end ferrule, DIN 46228 pt 1, max.	2.5 mm ²			
Plug gauge in accordance with EN 60999 a x b; ø	2.8 mm x 2.0 mm			
Clampable conductor	Cross-section for conductor connection	Type	fine-wired	
		nominal	0.5 mm ²	
	wire end ferrule	Stripping length	nominal	12 mm
		Recommended wire-end ferrule	H0.5/16 OR	
		Stripping length	nominal	10 mm
		Recommended wire-end ferrule	H0.5/10	
	Cross-section for conductor connection	Type	fine-wired	
		nominal	0.75 mm ²	
	wire end ferrule	Stripping length	nominal	12 mm
		Recommended wire-end ferrule	H0.75/16 W	
		Stripping length	nominal	10 mm
		Recommended wire-end ferrule	H0.75/10	
	Cross-section for conductor connection	Type	fine-wired	
		nominal	1 mm ²	
	wire end ferrule	Stripping length	nominal	12 mm
		Recommended wire-end ferrule	H1.0/16D R	
		Stripping length	nominal	10 mm
		Recommended wire-end ferrule	H1.0/10	
	Cross-section for conductor connection	Type	fine-wired	
		nominal	1.5 mm ²	
	wire end ferrule	Stripping length	nominal	10 mm
		Recommended wire-end ferrule	H1.5/10	
		Stripping length	nominal	12 mm
		Recommended wire-end ferrule	H1.5/16 R	
Cross-section for conductor connection	Type	fine-wired		
	nominal	2.5 mm ²		
wire end ferrule	Stripping length	nominal	10 mm	
	Recommended wire-end ferrule	H2.5/10		

Reference text The outside diameter of the plastic collar should not be larger than the pitch (P). Length of ferrules is to be chosen depending on the product and the rated voltage.

BLF 5.00HC/06/180 SN OR BX

Weidmüller Interface GmbH & Co. KG
 Klingenbergstraße 26
 D-32758 Detmold
 Germany

www.weidmueller.com

Technical data

Rated data acc. to IEC

tested acc. to standard	IEC 60664-1, IEC 61984	Rated current, min. number of poles (Tu=20°C)	23 A
Rated current, max. number of poles (Tu=20°C)	18 A	Rated current, min. number of poles (Tu=40°C)	21 A
Rated current, max. number of poles (Tu=40°C)	16 A	Rated voltage for surge voltage class / pollution degree II/2	400 V
Rated voltage for surge voltage class / pollution degree III/2	320 V	Rated voltage for surge voltage class / pollution degree III/3	250 V
Rated impulse voltage for surge voltage class/ pollution degree II/2	4 kV	Rated impulse voltage for surge voltage class/ pollution degree III/2	4 kV
Rated impulse voltage for surge voltage class/ contamination degree III/3	4 kV	Short-time withstand current resistance	3 x 1s with 120 A

Rated data acc. to CSA

Institute (CSA)	CSA	Certificate No. (CSA)	200039-1121690
Rated voltage (Use group B / CSA)	300 V	Rated voltage (Use group D / CSA)	300 V
Rated current (Use group B / CSA)	10 A	Rated current (Use group D / CSA)	10 A
Wire cross-section, AWG, min.	AWG 12	Wire cross-section, AWG, max.	AWG 26
Reference to approval values	Specifications are maximum values, details - see approval certificate.		

Rated data acc. to UL 1059

Institute (cURus)	CURUS	Certificate No. (cURus)	E60693
Rated voltage (Use group B / UL 1059)	300 V	Rated voltage (Use group D / UL 1059)	300 V
Rated current (Use group B / UL 1059)	18.5 A	Rated current (Use group D / UL 1059)	10 A
Wire cross-section, AWG, min.	AWG 26	Wire cross-section, AWG, max.	AWG 12
Reference to approval values	Specifications are maximum values, details - see approval certificate.		

Packing

Packaging	Box	VPE length	352.00 mm
VPE width	137.00 mm	VPE height	38.00 mm

Type tests

Test: Durability of markings	Standard	IEC 61984 section 6.2 and 7.3.2 / 10.08 taking pattern from IEC 60068-2-70 / 12.95
	Test	mark of origin, type identification, pitch, type of material, date clock
	Evaluation	available
	Test	durability
Test: Misengagement (Non-interchangeability)	Standard	IEC 61984 section 6.3 and 6.9.1 / 10.08, IEC 60512-13-5 / 02.06
	Test	180° turned with coding elements
	Evaluation	passed
	Test	visual examination
Test: Clampable cross section	Evaluation	passed
	Standard	IEC 60999-1 section 7 and 9.1 / 11.99, IEC 60947-1 section 8.2.4.5.1 / 06.07
	Conductor type	Type of conductor solid 0.2 mm ² and conductor cross-section

BLF 5.00HC/06/180 SN OR BX

Weidmüller Interface GmbH & Co. KG
 Klingenbergstraße 26
 D-32758 Detmold
 Germany

www.weidmueller.com

Technical data

		Type of conductor and conductor cross-section	stranded 0.2 mm ²
		Type of conductor and conductor cross-section	solid 2.5 mm ²
		Type of conductor and conductor cross-section	stranded 2.5 mm ²
		Type of conductor and conductor cross-section	AWG 26/1
		Type of conductor and conductor cross-section	AWG 26/19
		Type of conductor and conductor cross-section	AWG 14/1
		Type of conductor and conductor cross-section	AWG 14/19
	Evaluation	passed	
	Standard	IEC 60999-1 section 9.4 / 11.99	
	Requirement	0.2 kg	
	Conductor type	Type of conductor and conductor cross-section	AWG 26/1
		Type of conductor and conductor cross-section	AWG 26/19
	Evaluation	passed	
	Requirement	0.3 kg	
	Conductor type	Type of conductor and conductor cross-section	H05V-U0.5
		Type of conductor and conductor cross-section	H05V-K0.5
	Evaluation	passed	
	Requirement	0.7 kg	
	Conductor type	Type of conductor and conductor cross-section	H07V-U2.5
		Type of conductor and conductor cross-section	H07V-K2.5
		Type of conductor and conductor cross-section	AWG 14/1
		Type of conductor and conductor cross-section	AWG 14/19
	Evaluation	passed	
	Standard	IEC 60999-1 section 9.5 / 11.99	
	Requirement	≥10 N	
	Conductor type	Type of conductor and conductor cross-section	AWG 26/1
		Type of conductor and conductor cross-section	AWG 26/19
	Evaluation	passed	
	Requirement	≥20 N	
Test for damage to and accidental loosening of conductors			
Pull-out test			

BLF 5.00HC/06/180 SN OR BX

Weidmüller Interface GmbH & Co. KG
 Klingenbergstraße 26
 D-32758 Detmold
 Germany

Technical data

www.weidmueller.com

Conductor type	Type of conductor and conductor cross-section	H05V-U0.5
	Type of conductor and conductor cross-section	H05V-K0.5
Evaluation	passed	
Requirement	≥50 N	
Conductor type	Type of conductor and conductor cross-section	H07V-U2.5
	Type of conductor and conductor cross-section	H07V-K2.5
	Type of conductor and conductor cross-section	AWG 14/1
	Type of conductor and conductor cross-section	AWG 14/19
Evaluation	passed	

Important note

IPC conformity Conformity: The products are developed, manufactured and delivered according international recognized standards and norms and comply with the assured properties in the data sheet resp. fulfill decorative properties in accordance with IPC-A-610 "Class 2". Further claims on the products can be evaluated on request.

- Notes**
- Additional variants on request
 - Gold-plated contact surfaces on request
 - Rated current related to rated cross-section & min. No. of poles.
 - Wire end ferrule without plastic collar to DIN 46228/1
 - Wire end ferrule with plastic collar to DIN 46228/4
 - P on drawing = pitch
 - Crimping shape "A" for wire end ferrules with PZ 6/5 crimping tool recommended.
 - The test point can only be used as potential-pickup point.
 - In accordance with IEC 61984, OMNIMATE-connectors are connectors without breaking capacity (COC). During designated use, connectors are not allowed to be engaged or disengaged when live or under load
 - Long term storage of the product with average temperature of 50 °C and maximum humidity 70%, 36 months

Classifications

ETIM 8.0	EC002638	ETIM 9.0	EC002638
ETIM 10.0	EC002638	ECLASS 14.0	27-46-02-02
ECLASS 15.0	27-46-02-02		

BLF 5.00HC/06/180 SN OR BX

Weidmüller Interface GmbH & Co. KG
 Klingenbergstraße 26
 D-32758 Detmold
 Germany

www.weidmueller.com

Drawings

Product image

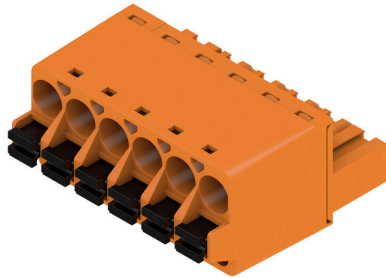

Dimensional drawing

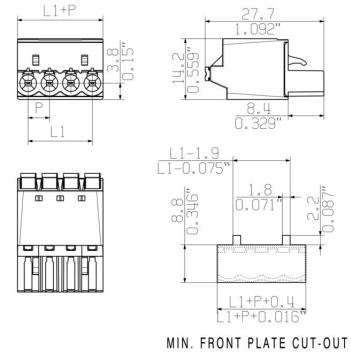

Graph

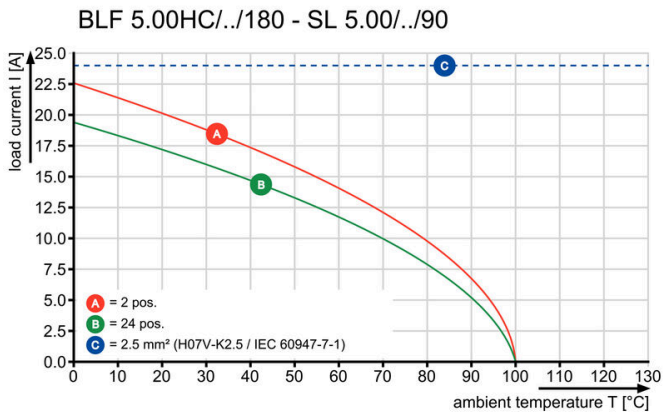

Graph



Uncompromising functionality High vibration resistance

Product benefits



Uncompromising functionality High vibration resistance

Product benefits



Solid PUSH IN contact Safe and durable

Drawings

Product benefits



Cost-effective wiring Quick and intuitive operation

Product benefits



Wide clamping range Tool-free wire connection

BLF 5.00HC/06/180 SN OR BX

Weidmüller Interface GmbH & Co. KG
 Klingenbergstraße 26
 D-32758 Detmold
 Germany

www.weidmueller.com

Accessories

Coding elements



Only connects what is supposed to be connected: the right connection at the right place.
 Coding elements and locking devices clearly assign connecting elements during the manufacturing process and operation
 The coding elements and locking devices are inserted prior to assembly or during the cable assembly phase. The Weidmüller alternative: configure online using the variant configurator to precode prior to delivery. Incorrect assembly on the circuit board and incorrect plugging of connecting elements is no longer possible. The advantage: no troubleshooting during manufacture and no operational errors by the user.

General ordering data

Type	BLZ/SL KO BK BX	Version
Order No.	1545710000	PCB plug-in connector, Accessories, Coding element, black, Number of poles: 1
GTIN (EAN)	4008190087142	
Qty.	50 ST	
Type	BLZ/SL KO OR BX	Version
Order No.	1573010000	PCB plug-in connector, Accessories, Coding element, orange, Number of poles: 1
GTIN (EAN)	4008190048396	
Qty.	100 ST	

Slotted screwdriver



Slotted screwdriver with rounded blade SD DIN 5265, ISO 2380/2, output to DIN 5264, ISO 2380/1. ChromTop tip, SoftFinish grip

General ordering data

Type	SDS 0.6X3.5X100	Version
Order No.	2749340000	Screwdriver, Blade width (B): 3.5 mm, Blade length: 100 mm, Blade thickness (A): 0.6 mm
GTIN (EAN)	4050118895568	
Qty.	1 ST	
Type	SDS 0.6X3.5X200	Version
Order No.	9010110000	Screwdriver, Screwdriver
GTIN (EAN)	4032248300754	
Qty.	1 ST	
Type	SDIS 0.6X3.5X100	Version
Order No.	2749810000	Screwdriver, Blade width (B): 3.5 mm, Blade length: 100 mm, Blade thickness (A): 0.6 mm
GTIN (EAN)	4050118897012	
Qty.	1 ST	

BLF 5.00HC/06/180 SN OR BX

Weidmüller Interface GmbH & Co. KG
Klingenbergstraße 26
D-32758 Detmold
Germany

www.weidmueller.com

Counterpart

SL 5.00/135



Male connectors with 135° outlet direction. The solder pin length is optimised for wave flow soldering. The pin headers provide space for labelling and can be coded.

General ordering data

Type	SL 5.00/06/135 3.2SN OR...	Version
Order No.	1630290000	PCB plug-in connector, male header, open side, THT solder
GTIN (EAN)	4008190203719	connection, 5.00 mm, Number of poles: 6, 135°, Solder pin length (l):
Qty.	50 ST	3.2 mm, tinned, orange, Box

SL 5.00/135B



Male connectors with 135° outlet direction. The solder pin length is optimised for wave flow soldering. The pin headers provide space for labelling and can be coded.

General ordering data

Type	SL 5.00/06/135B 3.2SN O...	Version
Order No.	1630520000	PCB plug-in connector, male header, Dovetails for fixing blocks, THT
GTIN (EAN)	4008190203948	solder connection, 5.00 mm, Number of poles: 6, 135°, Solder pin
Qty.	50 ST	length (l): 3.2 mm, tinned, orange, Box

SL 5.00/180



Male connectors with straight outlet direction. The solder pin length is optimised for wave flow soldering. The pin headers provide space for labelling and can be coded.

General ordering data

Type	SL 5.00/06/180 3.2SN OR...	Version
Order No.	1581360000	PCB plug-in connector, male header, open side, THT solder
GTIN (EAN)	4008190035303	connection, 5.00 mm, Number of poles: 6, 180°, Solder pin length (l):
Qty.	50 ST	3.2 mm, tinned, orange, Box

BLF 5.00HC/06/180 SN OR BX

Weidmüller Interface GmbH & Co. KG
 Klingenbergstraße 26
 D-32758 Detmold
 Germany

www.weidmueller.com

Counterpart

SL 5.00/180B



Male connectors with straight outlet direction. The solder pin length is optimised for wave flow soldering. The pin headers provide space for labelling and can be coded.

General ordering data

Type	SL 5.00/06/180B 3.2SN O...	Version
Order No.	1581820000	PCB plug-in connector, male header, Dovetails for fixing blocks, THT
GTIN (EAN)	4008190098872	solder connection, 5.00 mm, Number of poles: 6, 180°, Solder pin
Qty.	50 ST	length (l): 3.2 mm, tinned, orange, Box

SL 5.00/90



Male connectors with 90° outlet direction. The solder pin length is optimised for wave flow soldering. The pin headers provide space for labelling and can be coded.

General ordering data

Type	SL 5.00/06/90 3.2SN OR ...	Version
Order No.	1571170000	PCB plug-in connector, male header, open side, THT solder
GTIN (EAN)	4008190112325	connection, 5.00 mm, Number of poles: 6, 90°, Solder pin length (l):
Qty.	50 ST	3.2 mm, tinned, orange, Box
Type	SL 5.00/06/90 4.5SN BK ...	Version
Order No.	1596180000	PCB plug-in connector, male header, open side, THT solder
GTIN (EAN)	4008190105655	connection, 5.00 mm, Number of poles: 6, 90°, Solder pin length (l):
Qty.	50 ST	4.5 mm, tinned, black, Box

SL 5.00/90B



Male connectors with 90° outlet direction. The solder pin length is optimised for wave flow soldering. The pin headers provide space for labelling and can be coded.

BLF 5.00HC/06/180 SN OR BX

Weidmüller Interface GmbH & Co. KG
 Klingenbergstraße 26
 D-32758 Detmold
 Germany

www.weidmueller.com

Counterpart

General ordering data

Type	SL 5.00/06/90B 3.2SN OR...	Version
Order No.	1580900000	PCB plug-in connector, male header, Dovetails for fixing blocks, THT
GTIN (EAN)	4008190130695	solder connection, 5.00 mm, Number of poles: 6, 90°, Solder pin
Qty.	50 ST	length (l): 3.2 mm, tinned, orange, Box

SLD 5.00/180G



2-tier male header with parallel pin arrangement. The solder pin length is optimised for wave flow soldering. The pin headers provide space for labelling and can be coded.

General ordering data

Type	SLD 5.00/12/180G 3.2SN ...	Version
Order No.	1614850000	PCB plug-in connector, male header, closed side, THT solder
GTIN (EAN)	4008190039257	connection, 5.00 mm, Number of poles: 12, 180°, Solder pin length
Qty.	50 ST	(l): 3.2 mm, tinned, orange, Box

SLD 5.00/90G

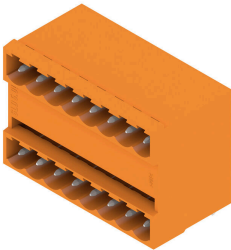

2-tier male header with parallel pin arrangement. The solder pin length is optimised for wave flow soldering. The pin headers provide space for labelling and can be coded.

General ordering data

Type	SLD 5.00/12/90G 3.2 SN ...	Version
Order No.	1614390000	PCB plug-in connector, male header, closed side, THT solder
GTIN (EAN)	4008190029753	connection, 5.00 mm, Number of poles: 12, 90°, Solder pin length (l):
Qty.	50 ST	3.2 mm, tinned, orange, Box

BLF 5.00HC/06/180 SN OR BX

Weidmüller Interface GmbH & Co. KG
 Klingenbergstraße 26
 D-32758 Detmold
 Germany

www.weidmueller.com

Counterpart

SL-SMT 5.00HC/180 Box



High-temperature-resistant, straight, open pin header. Packed in box or tape. On tape and with 1.5 mm solder pin, optimised for automatic assembly. 3.2 mm solder pin suitable for reflow and wave soldering. The pin headers provide space for labelling and can be coded. HC = High Current.

General ordering data

Type	SL-SMT 5.00HC/06/180 1...	Version
Order No.	1796520000	PCB plug-in connector, male header, open side, THT/THR solder connection, 5.00 mm, Number of poles: 6, 180°, Solder pin length (l):
GTIN (EAN)	4032248237050	1.5 mm, tinned, black, Box
Qty.	50 ST	
Type	SL-SMT 5.00HC/06/180 3...	Version
Order No.	1840960000	PCB plug-in connector, male header, open side, THT/THR solder connection, 5.00 mm, Number of poles: 6, 180°, Solder pin length (l):
GTIN (EAN)	4032248351855	3.2 mm, tinned, black, Box
Qty.	50 ST	

SL-SMT 5.00HC/180 Tape



High-temperature-resistant, straight, open pin header. Packed in box or tape. On tape and with 1.5 mm solder pin, optimised for automatic assembly. 3.2 mm solder pin suitable for reflow and wave soldering. The pin headers provide space for labelling and can be coded. HC = High Current.

General ordering data

Type	SL-SMT 5.00HC/06/180 1...	Version
Order No.	1797840000	PCB plug-in connector, male header, open side, THT/THR solder connection, 5.00 mm, Number of poles: 6, 180°, Solder pin length (l):
GTIN (EAN)	4032248239849	1.5 mm, tinned, black, Tape
Qty.	250 ST	

SL-SMT 5.00HC/180G Box



High-temperature-resistant pin header, packed in box or tape. On tape, with 1.5 mm solder pin, optimised for automatic assembly. 3.2 mm solder pin suitable for reflow and wave soldering. The pin headers provide space for labelling and can be coded. HC = High Current.

BLF 5.00HC/06/180 SN OR BX

Weidmüller Interface GmbH & Co. KG
 Klingenbergstraße 26
 D-32758 Detmold
 Germany

Counterpart

www.weidmueller.com

General ordering data

Type	SL-SMT 5.00HC/06/180G 1...	Version
Order No.	1796670000	PCB plug-in connector, male header, closed side, THT/THR solder connection, 5.00 mm, Number of poles: 6, 180°, Solder pin length (l):
GTIN (EAN)	4032248237296	1.5 mm, tinned, black, Box
Qty.	50 ST	
Type	SL-SMT 5.00HC/06/180G 3...	Version
Order No.	1841200000	PCB plug-in connector, male header, closed side, THT/THR solder connection, 5.00 mm, Number of poles: 6, 180°, Solder pin length (l):
GTIN (EAN)	4032248352098	3.2 mm, tinned, black, Box
Qty.	50 ST	

SL-SMT 5.00HC/180G Tape



High-temperature-resistant pin header, packed in box or tape. On tape, with 1.5 mm solder pin, optimised for automatic assembly. 3.2 mm solder pin suitable for reflow and wave soldering. The pin headers provide space for labelling and can be coded. HC = High Current.

General ordering data

Type	SL-SMT 5.00HC/06/180G 1...	Version
Order No.	1797910000	PCB plug-in connector, male header, closed side, THT/THR solder connection, 5.00 mm, Number of poles: 6, 180°, Solder pin length (l):
GTIN (EAN)	4032248239917	1.5 mm, tinned, black, Tape
Qty.	250 ST	

SL-SMT 5.00HC/90 Box



High-temperature-resistant, 90° angled, open male header. Packed in box or tape. On tape, with 1.5 mm solder pin, optimised for automatic assembly. 3.2 mm solder pin suitable for reflow and wave soldering. The pin headers provide space for labelling and can be coded. HC = High Current.

General ordering data

Type	SL-SMT 5.00HC/06/90 1.5...	Version
Order No.	1796970000	PCB plug-in connector, male header, open side, THT/THR solder connection, 5.00 mm, Number of poles: 6, 90°, Solder pin length (l):
GTIN (EAN)	4032248237753	1.5 mm, tinned, black, Box
Qty.	50 ST	
Type	SL-SMT 5.00HC/06/90 3.2...	Version
Order No.	1839930000	PCB plug-in connector, male header, open side, THT/THR solder connection, 5.00 mm, Number of poles: 6, 90°, Solder pin length (l):
GTIN (EAN)	4032248350575	3.2 mm, tinned, black, Box
Qty.	50 ST	

BLF 5.00HC/06/180 SN OR BX

Weidmüller Interface GmbH & Co. KG
 Klingenbergstraße 26
 D-32758 Detmold
 Germany

www.weidmueller.com

Counterpart

SL-SMT 5.00HC/90 Tape



High-temperature-resistant, 90° angled, open male header. Packed in box or tape. On tape, with 1.5 mm solder pin, optimised for automatic assembly. 3.2 mm solder pin suitable for reflow and wave soldering. The pin headers provide space for labelling and can be coded. HC = High Current.

General ordering data

Type	SL-SMT 5.00HC/06/90 1.5...	Version
Order No.	1797660000	PCB plug-in connector, male header, open side, THT/THR solder
GTIN (EAN)	4032248239665	connection, 5.00 mm, Number of poles: 6, 90°, Solder pin length (l):
Qty.	350 ST	1.5 mm, tinned, black, Tape

SL-SMT 5.00HC/90G Box



High-temperature-resistant pin header, packed in box or tape. On tape, with 1.5 mm solder pin, optimised for automatic assembly. 3.2 mm solder pin suitable for reflow and wave soldering. The pin headers provide space for labelling and can be coded. HC = High Current.

General ordering data

Type	SL-SMT 5.00HC/06/90G 1....	Version
Order No.	1797120000	PCB plug-in connector, male header, closed side, THT/THR solder
GTIN (EAN)	4032248237906	connection, 5.00 mm, Number of poles: 6, 90°, Solder pin length (l):
Qty.	50 ST	1.5 mm, tinned, black, Box
Type	SL-SMT 5.00HC/06/90G 3....	Version
Order No.	1840160000	PCB plug-in connector, male header, closed side, THT/THR solder
GTIN (EAN)	4032248350902	connection, 5.00 mm, Number of poles: 6, 90°, Solder pin length (l):
Qty.	50 ST	3.2 mm, tinned, black, Box

SL-SMT 5.00HC/90G Tape



High-temperature-resistant pin header, packed in box or tape. On tape, with 1.5 mm solder pin, optimised for automatic assembly. 3.2 mm solder pin suitable for reflow and wave soldering. The pin headers provide space for labelling and can be coded. HC = High Current.

BLF 5.00HC/06/180 SN OR BX

Weidmüller Interface GmbH & Co. KG
 Klingenbergstraße 26
 D-32758 Detmold
 Germany

Counterpart

www.weidmueller.com

General ordering data

Type	SL-SMT 5.00HC/06/90G 1...	Version
Order No.	1797730000	PCB plug-in connector, male header, closed side, THT/THR solder connection, 5.00 mm, Number of poles: 6, 90°, Solder pin length (l):
GTIN (EAN)	4032248239733	1.5 mm, tinned, black, Tape
Qty.	350 ST	

SLDV-THR 5.00/180G

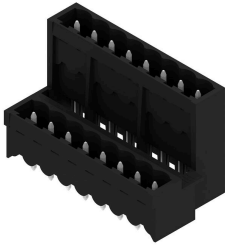

High-temperature resistant, double level, laterally offset, closed ended male header, with solder flange option. 1.5 mm solder pin suitable for reflow soldering. 3.2 mm solder pin suitable for reflow and wave soldering. The pin headers provide space for labelling and can be coded.

General ordering data

Type	SLDV-THR 5.00/12/180G 1...	Version
Order No.	1895020000	PCB plug-in connector, male header, closed side, THT/THR solder connection, 5.00 mm, Number of poles: 12, 180°, Solder pin length (l): 1.5 mm, tinned, black, Box
GTIN (EAN)	4032248509737	
Qty.	50 ST	
Type	SLDV-THR 5.00/12/180G 3...	Version
Order No.	1882720000	PCB plug-in connector, male header, closed side, THT/THR solder connection, 5.00 mm, Number of poles: 12, 180°, Solder pin length (l): 3.2 mm, tinned, black, Box
GTIN (EAN)	4032248486298	
Qty.	50 ST	