

## BLF 5.08HC/24/180LR SN BK BX

Weidmüller Interface GmbH & Co. KG

Klingenbergstraße 26

D-32758 Detmold

Germany

www.weidmueller.com

### Product image

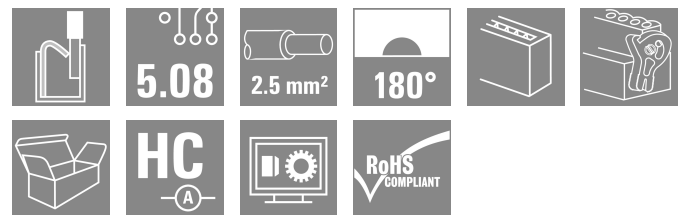

Just as reliable as the millionfold proven original and featuring innovative details:

The BLF 5.08HC PUSH IN version of the BLZP 5.08HC female connector is not only different in terms of connection system; it also has a more compact design. Weidmüller's innovative PUSH IN spring connection system stands for the future of easy and tool-free wire connection. HC = High Current.

In terms of versatility, the BLF 5.08HC offers just as much as the version which served as a model:

- 3 tested-and-proven wire outlet directions provide the usual flexibility for application-specific design
- 4 flange variations and the patented release latch allow the locking concept to be based on the requirements of the user
- Use the BLF 5.08HC and SL 5.08HC plug combination to reach the max. rated specifications

### General ordering data

Version	PCB plug-in connector, female plug, 5.08 mm, Number of poles: 24, 180°, PUSH IN with actuator, Clamping range, max. : 3.31 mm², Box
Order No.	<a href="#">1014360000</a>
Type	BLF 5.08HC/24/180LR SN BK BX
GTIN (EAN)	4032248722990
Qty.	12 items
Product data	IEC: 400 V / 24 A / 0.2 - 2.5 mm² UL: 300 V / 18.5 A / AWG 26 - AWG 12
Packaging	Box

## BLF 5.08HC/24/180LR SN BK BX

Weidmüller Interface GmbH & Co. KG  
Klingenbergstraße 26  
D-32758 Detmold  
Germany

www.weidmueller.com

## Technical data

## Approvals

Approvals



ROHS	Conform
UL File Number Search	<a href="#">UL Website</a>
Certificate No. (cURus)	E60693

## Dimensions and weights

Depth	29.6 mm	Depth (inches)	1.1654 inch
Height	14.3 mm	Height (inches)	0.563 inch
Width	131.74 mm	Width (inches)	5.1866 inch
Net weight	44.52 g		

## Environmental Product Compliance

RoHS Compliance Status	Compliant without exemption		
REACH SVHC	No SVHC above 0.1 wt%		
Product Carbon Footprint	Cradle to gate	3,101 kg CO2 eq.	

## System Parameters

Product family	OMNIMATE Signal - series BL/SL 5.08	Type of connection	Field connection
Wire connection method	PUSH IN with actuator	Pitch in mm (P)	5.08 mm
Pitch in inches (P)	0.200 "	Conductor outlet direction	180°
Number of poles	24	L1 in mm	116.84 mm
L1 in inches	4.600 "	Number of rows	1
Pin series quantity	1	Rated cross-section	2.5 mm <sup>2</sup>
Touch-safe protection acc. to DIN VDE 57 106	Safe from finger touch	Touch-safe protection acc. to DIN VDE 0470	IP20 plugged/ IP10 unplugged
Protection degree	IP20	Volume resistance	≤5 mΩ
Can be coded	Yes	Stripping length	10 mm
Screwdriver blade	0.6 x 3.5	Screwdriver blade standard	DIN 5264
Plugging cycles	25	Plugging force/pole, max.	7 N
Pulling force/pole, max.	5.5 N		

## Material data

Insulating material	PBT	Colour	black
Colour of operational elements	orange	Colour chart (similar)	RAL 9011
Insulating material group	IIIa	Comparative Tracking Index (CTI)	≥ 200
Moisture Level (MSL)		UL 94 flammability rating	V-0
Contact material	Cu-alloy	Contact surface	tinned
Layer structure of plug contact	4...8 μm Sn hot-dip tinned	Storage temperature, min.	-40 °C
Storage temperature, max.	70 °C	Operating temperature, min.	-50 °C
Operating temperature, max.	100 °C	Temperature range, installation, min.	-30 °C
Temperature range, installation, max.	100 °C		

## Conductors suitable for connection

Clamping range, min.	0.13 mm <sup>2</sup>
Clamping range, max.	3.31 mm <sup>2</sup>

## BLF 5.08HC/24/180LR SN BK BX

**Weidmüller Interface GmbH & Co. KG**  
 Klingenbergstraße 26  
 D-32758 Detmold  
 Germany

www.weidmueller.com

### Technical data

Wire connection cross section AWG, min.	AWG 26
Wire connection cross section AWG, max.	AWG 12
Solid, min. H05(07) V-U	0.2 mm <sup>2</sup>
Solid, max. H05(07) V-U	2.5 mm <sup>2</sup>
Flexible, min. H05(07) V-K	0.2 mm <sup>2</sup>
Flexible, max. H05(07) V-K	2.5 mm <sup>2</sup>
w. plastic collar ferrule, DIN 46228 pt 4, min.	0.25 mm <sup>2</sup>
w. plastic collar ferrule, DIN 46228 pt 4, max.	2.5 mm <sup>2</sup>
w. wire end ferrule, DIN 46228 pt 1, min.	0.25 mm <sup>2</sup>
w. wire end ferrule, DIN 46228 pt 1, max.	2.5 mm <sup>2</sup>
Plug gauge in accordance with EN 60999 a x b; ø	2.8 mm x 2.0 mm

Clampable conductor	Cross-section for conductor connection	Type	fine-wired	
		nominal	nominal	
wire end ferrule		Stripping length	nominal	12 mm
		Recommended wire-end ferrule	<a href="#">H0.5/16 OR</a>	
		Stripping length	nominal	10 mm
		Recommended wire-end ferrule	<a href="#">H0.5/10</a>	
wire end ferrule		Stripping length	nominal	12 mm
		Recommended wire-end ferrule	<a href="#">H0.75/16 W</a>	
		Stripping length	nominal	10 mm
		Recommended wire-end ferrule	<a href="#">H0.75/10</a>	
wire end ferrule		Stripping length	nominal	12 mm
		Recommended wire-end ferrule	<a href="#">H1.0/16D R</a>	
		Stripping length	nominal	10 mm
		Recommended wire-end ferrule	<a href="#">H1.0/10</a>	
wire end ferrule		Stripping length	nominal	10 mm
		Recommended wire-end ferrule	<a href="#">H1.5/10</a>	
		Stripping length	nominal	12 mm
		Recommended wire-end ferrule	<a href="#">H1.5/16 R</a>	
wire end ferrule		Stripping length	nominal	10 mm
		Recommended wire-end ferrule	<a href="#">H2.5/10</a>	
		Stripping length	nominal	10 mm
		Recommended wire-end ferrule	<a href="#">H2.5/14DS BL</a>	

**Reference text** The outside diameter of the plastic collar should not be larger than the pitch (P), Length of ferrules is to be chosen depending on the product and the rated voltage.

## BLF 5.08HC/24/180LR SN BK BX

**Weidmüller Interface GmbH & Co. KG**  
 Klingenbergstraße 26  
 D-32758 Detmold  
 Germany

www.weidmueller.com

## Technical data

### Rated data acc. to IEC

tested acc. to standard	IEC 60664-1, IEC 61984	Rated current, min. number of poles (Tu=20°C)	24 A
Rated current, max. number of poles (Tu=20°C)	19 A	Rated current, min. number of poles (Tu=40°C)	21 A
Rated current, max. number of poles (Tu=40°C)	16.5 A	Rated voltage for surge voltage class / pollution degree II/2	400 V
Rated voltage for surge voltage class / pollution degree III/2	320 V	Rated voltage for surge voltage class / pollution degree III/3	250 V
Rated impulse voltage for surge voltage class/ pollution degree II/2	4 kV	Rated impulse voltage for surge voltage class/ pollution degree III/2	4 kV
Rated impulse voltage for surge voltage class/ contamination degree III/3	4 kV	Short-time withstand current resistance	3 x 1s with 120 A

### Rated data acc. to CSA

Institute (CSA)	CSA	Certificate No. (CSA)	200039-1121690
Rated voltage (Use group B / CSA)	300 V	Rated voltage (Use group D / CSA)	300 V
Rated current (Use group D / CSA)	10 A	Wire cross-section, AWG, min.	AWG 26
Wire cross-section, AWG, max.	AWG 12	Reference to approval values	Specifications are maximum values, details - see approval certificate.

### Rated data acc. to UL 1059

Institute (cURus)	CURUS	Certificate No. (cURus)	E60693
Rated voltage (Use group B / UL 1059)	300 V	Rated voltage (Use group D / UL 1059)	300 V
Rated current (Use group B / UL 1059)	18.5 A	Rated current (Use group D / UL 1059)	10 A
Wire cross-section, AWG, min.	AWG 26	Wire cross-section, AWG, max.	AWG 12
Reference to approval values	Specifications are maximum values, details - see approval certificate.		

### Packing

Packaging	Box	VPE length	351.00 mm
VPE width	136.00 mm	VPE height	38.00 mm

### Type tests

Test: Durability of markings	Standard	DIN EN 61984 section 7.3.2 / 09.02 taking pattern from DIN EN 60068-2-70 / 07.96
	Test	mark of origin, type identification, pitch, type of material, date clock
	Evaluation	available
	Test	durability
Test: Misengagement (Non-interchangeability)	Standard	DIN EN 61984 section 6.3 and 6.9.1 / 09.02, DIN EN 60512-13-5 / 11.08
	Test	180° turned with coding elements
	Evaluation	passed
	Test	visual examination
Test: Clampable cross section	Evaluation	passed
	Standard	DIN EN 60999-1 section 7 and 9.1 / 12.00, DIN EN 60947-1 section 8.2.4.5.1 / 04.08
	Conductor type	Type of conductor solid 0.2 mm <sup>2</sup> and conductor cross-section

**BLF 5.08HC/24/180LR SN BK BX**

**Weidmüller Interface GmbH & Co. KG**  
 Klingenbergstraße 26  
 D-32758 Detmold  
 Germany

www.weidmueller.com

**Technical data**

	Type of conductor and conductor cross-section	stranded 0.2 mm <sup>2</sup>
	Type of conductor and conductor cross-section	solid 2.5 mm <sup>2</sup>
	Type of conductor and conductor cross-section	stranded 2.5 mm <sup>2</sup>
	Type of conductor and conductor cross-section	AWG 26/1
	Type of conductor and conductor cross-section	AWG 26/19
	Type of conductor and conductor cross-section	AWG 14/1
	Type of conductor and conductor cross-section	AWG 14/19
	Evaluation	passed
Standard	DIN EN 60999-1 section 9.4 / 12.00	
Requirement	0.2 kg	
Conductor type	Type of conductor and conductor cross-section	AWG 26/1
	Type of conductor and conductor cross-section	AWG 26/19
Evaluation	passed	
Requirement	0.3 kg	
Conductor type	Type of conductor and conductor cross-section	H05V-U0.5
	Type of conductor and conductor cross-section	H05V-K0.5
Evaluation	passed	
Requirement	0.7 kg	
Conductor type	Type of conductor and conductor cross-section	H07V-U2.5
	Type of conductor and conductor cross-section	H07V-K2.5
Evaluation	passed	
Requirement	0.9 kg	
Conductor type	Type of conductor and conductor cross-section	AWG 12/1
	Type of conductor and conductor cross-section	AWG 12/19
Evaluation	passed	
Standard	DIN EN 60999-1 section 9.5 / 12.00	
Requirement	≥10 N	
Conductor type	Type of conductor and conductor cross-section	AWG 26/1
	Type of conductor and conductor cross-section	AWG 26/19

**BLF 5.08HC/24/180LR SN BK BX**

**Weidmüller Interface GmbH & Co. KG**  
 Klingenbergstraße 26  
 D-32758 Detmold  
 Germany

**Technical data**

www.weidmueller.com

Evaluation	passed	
Requirement	≥20 N	
Conductor type	Type of conductor and conductor cross-section	H05V-K0.5
	Type of conductor and conductor cross-section	H05V-U0.5
Evaluation	passed	
Requirement	≥50 N	
Conductor type	Type of conductor and conductor cross-section	H07V-U2.5
	Type of conductor and conductor cross-section	H07V-K2.5
Evaluation	passed	
Requirement	≥60 N	
Conductor type	Type of conductor and conductor cross-section	AWG 12/1
	Type of conductor and conductor cross-section	AWG 12/19
Evaluation	passed	

**Important note**

**IPC conformity** Conformity: The products are developed, manufactured and delivered according international recognized standards and norms and comply with the assured properties in the data sheet resp. fulfill decorative properties in accordance with IPC-A-610 "Class 2". Further claims on the products can be evaluated on request.

- Notes**
- Additional variants on request
  - Gold-plated contact surfaces on request
  - Rated current related to rated cross-section & min. No. of poles.
  - Wire end ferrule without plastic collar to DIN 46228/1
  - Wire end ferrule with plastic collar to DIN 46228/4
  - P on drawing = pitch
  - Crimping shape "A" for wire end ferrules with PZ 6/5 crimping tool recommended.
  - The test point can only be used as potential-pickup point.
  - In accordance with IEC 61984, OMNIMATE-connectors are connectors without breaking capacity (COC). During designated use, connectors are not allowed to be engaged or disengaged when live or under load
  - Long term storage of the product with average temperature of 50 °C and maximum humidity 70%, 36 months

**Classifications**

ETIM 8.0	EC002638	ETIM 9.0	EC002638
ETIM 10.0	EC002638	ECLASS 14.0	27-46-02-02
ECLASS 15.0	27-46-02-02		

**BLF 5.08HC/24/180LR SN BK BX**

**Weidmüller Interface GmbH & Co. KG**  
 Klingenbergstraße 26  
 D-32758 Detmold  
 Germany

www.weidmueller.com

Drawings

Product image

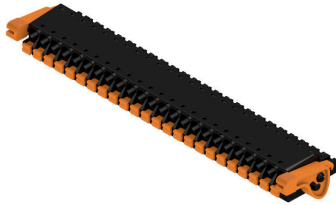

Dimensional drawing

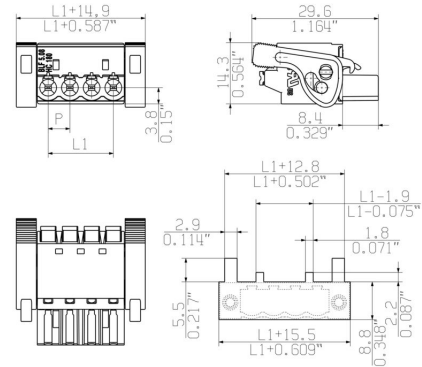

MIN. FRONT PLATE CUT-OUT

Graph

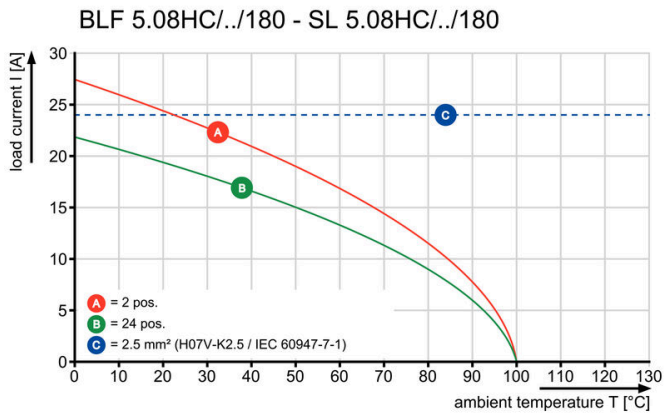

Graph

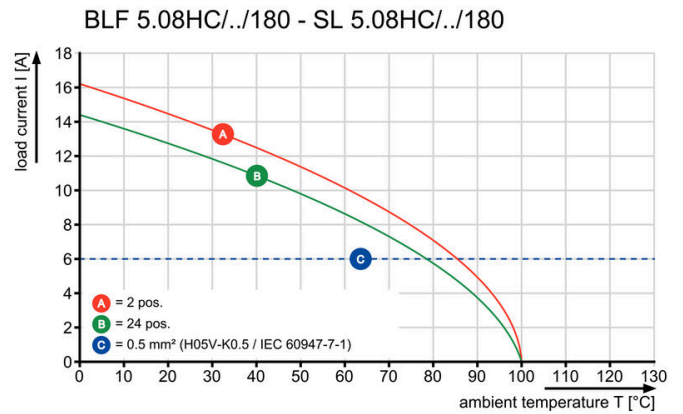

Uncompromising functionality High vibration resistance

**Drawings**

**Product benefits**



Solid PUSH IN contact  
Safe and durable

**Product benefits**



Cost-effective wiring  
Quick and intuitive operation

**Product benefits**

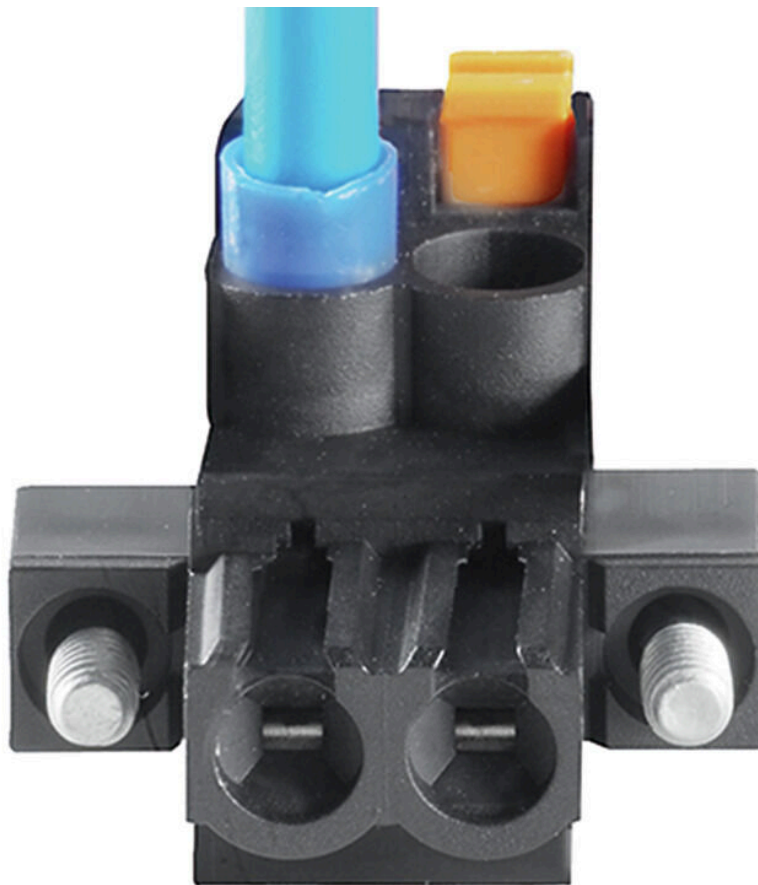

Wide clamping range  
Tool-free wire connection



**Product benefits**

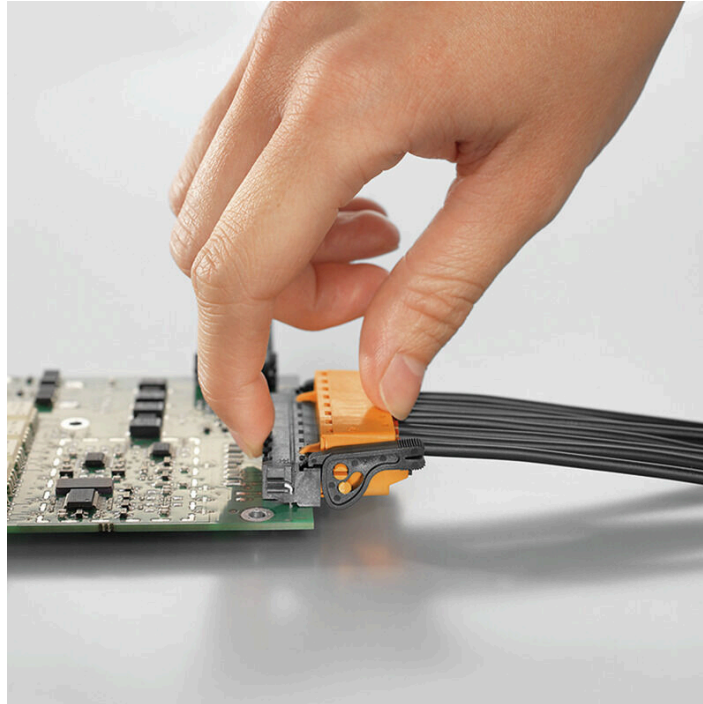

Self-locking Immediately on plugging in

**Uncompromising functionality**  
**High vibration resistance**

