

BLF 5.08HC/09/180 SN BK BX

Weidmüller Interface GmbH & Co. KG
 Klingenbergstraße 26
 D-32758 Detmold
 Germany

www.weidmueller.com

Product image

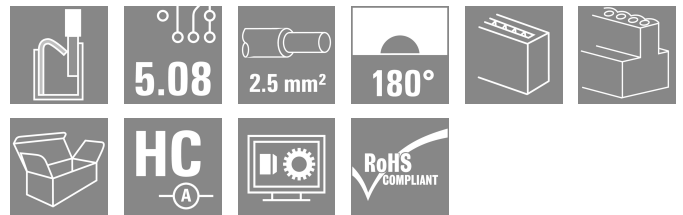

Just as reliable as the millionfold proven original and featuring innovative details:

The BLF 5.08HC PUSH IN version of the BLZP 5.08HC female connector is not only different in terms of connection system; it also has a more compact design. Weidmüller's innovative PUSH IN spring connection system stands for the future of easy and tool-free wire connection. HC = High Current.

In terms of versatility, the BLF 5.08HC offers just as much as the version which served as a model:

- 3 tested-and-proven wire outlet directions provide the usual flexibility for application-specific design
- 4 flange variations and the patented release latch allow the locking concept to be based on the requirements of the user
- Use the BLF 5.08HC and SL 5.08HC plug combination to reach the max. rated specifications

General ordering data

Version	PCB plug-in connector, female plug, 5.08 mm, Number of poles: 9, 180°, PUSH IN with actuator, Clamping range, max.: 3.31 mm², Box
Order No.	1013510000
Type	BLF 5.08HC/09/180 SN BK BX
GTIN (EAN)	4032248721658
Qty.	36 items
Product data	IEC: 400 V / 24 A / 0.2 - 2.5 mm² UL: 300 V / 18.5 A / AWG 26 - AWG 12
Packaging	Box

BLF 5.08HC/09/180 SN BK BX

Weidmüller Interface GmbH & Co. KG
Klingenbergstraße 26
D-32758 Detmold
Germany

www.weidmueller.com

Technical data

Approvals

Approvals



ROHS	Conform
UL File Number Search	UL Website
Certificate No. (cURus)	E60693

Dimensions and weights

Depth	27.7 mm	Depth (inches)	1.0905 inch
Height	14.2 mm	Height (inches)	0.5591 inch
Width	45.72 mm	Width (inches)	1.8 inch
Net weight	18.11 g		

Environmental Product Compliance

RoHS Compliance Status	Compliant without exemption		
REACH SVHC	No SVHC above 0.1 wt%		
Product Carbon Footprint	Cradle to gate	1,316 kg CO2 eq.	

System Parameters

Product family	OMNIMATE Signal - series BL/SL 5.08	Type of connection	Field connection
Wire connection method	PUSH IN with actuator	Pitch in mm (P)	5.08 mm
Pitch in inches (P)	0.200 "	Conductor outlet direction	180°
Number of poles	9	L1 in mm	40.64 mm
L1 in inches	1.600 "	Number of rows	1
Pin series quantity	1	Rated cross-section	2.5 mm ²
Touch-safe protection acc. to DIN VDE 57 106	Safe from finger touch	Touch-safe protection acc. to DIN VDE 0470	IP20 plugged/ IP10 unplugged
Protection degree	IP20	Volume resistance	≤5 mΩ
Can be coded	Yes	Stripping length	10 mm
Screwdriver blade	0.6 x 3.5	Screwdriver blade standard	DIN 5264
Plugging cycles	25	Plugging force/pole, max.	7 N
Pulling force/pole, max.	5.5 N		

Material data

Insulating material	PBT	Colour	black
Colour of operational elements	orange	Colour chart (similar)	RAL 9011
Insulating material group	IIIa	Comparative Tracking Index (CTI)	≥ 200
Moisture Level (MSL)		UL 94 flammability rating	V-0
Contact material	Cu-alloy	Contact surface	tinned
Layer structure of plug contact	4...8 μm Sn hot-dip tinned	Storage temperature, min.	-40 °C
Storage temperature, max.	70 °C	Operating temperature, min.	-50 °C
Operating temperature, max.	100 °C	Temperature range, installation, min.	-30 °C
Temperature range, installation, max.	100 °C		

Conductors suitable for connection

Clamping range, min.	0.13 mm ²
Clamping range, max.	3.31 mm ²

BLF 5.08HC/09/180 SN BK BX

Weidmüller Interface GmbH & Co. KG
 Klingenbergstraße 26
 D-32758 Detmold
 Germany

www.weidmueller.com

Technical data

Wire connection cross section AWG, min.	AWG 26
Wire connection cross section AWG, max.	AWG 12
Solid, min. H05(07) V-U	0.2 mm ²
Solid, max. H05(07) V-U	2.5 mm ²
Flexible, min. H05(07) V-K	0.2 mm ²
Flexible, max. H05(07) V-K	2.5 mm ²
w. plastic collar ferrule, DIN 46228 pt 4, min.	0.25 mm ²
w. plastic collar ferrule, DIN 46228 pt 4, max.	2.5 mm ²
w. wire end ferrule, DIN 46228 pt 1, min.	0.2 mm ²
w. wire end ferrule, DIN 46228 pt 1, max.	2.5 mm ²
Plug gauge in accordance with EN 60999 a x b; ø	2.8 mm x 2.0 mm

Clampable conductor	Cross-section for conductor connection	Type	fine-wired	
		nominal	nominal	
wire end ferrule		Stripping length	nominal	12 mm
		Recommended wire-end ferrule	H0.5/16 OR	
		Stripping length	nominal	10 mm
		Recommended wire-end ferrule	H0.5/10	
wire end ferrule		Stripping length	nominal	12 mm
		Recommended wire-end ferrule	H0.75/16 W	
		Stripping length	nominal	10 mm
		Recommended wire-end ferrule	H0.75/10	
wire end ferrule		Stripping length	nominal	12 mm
		Recommended wire-end ferrule	H1.0/16D R	
		Stripping length	nominal	10 mm
		Recommended wire-end ferrule	H1.0/10	
wire end ferrule		Stripping length	nominal	10 mm
		Recommended wire-end ferrule	H1.5/10	
		Stripping length	nominal	12 mm
		Recommended wire-end ferrule	H1.5/16 R	
wire end ferrule		Stripping length	nominal	10 mm
		Recommended wire-end ferrule	H2.5/10	
		Stripping length	nominal	10 mm
		Recommended wire-end ferrule	H2.5/14DS BL	

Reference text The outside diameter of the plastic collar should not be larger than the pitch (P), Length of ferrules is to be chosen depending on the product and the rated voltage.

BLF 5.08HC/09/180 SN BK BX

Weidmüller Interface GmbH & Co. KG
 Klingenbergstraße 26
 D-32758 Detmold
 Germany

www.weidmueller.com

Technical data

Rated data acc. to IEC

tested acc. to standard	IEC 60664-1, IEC 61984	Rated current, min. number of poles (Tu=20°C)	24 A
Rated current, max. number of poles (Tu=20°C)	19 A	Rated current, min. number of poles (Tu=40°C)	21 A
Rated current, max. number of poles (Tu=40°C)	16.5 A	Rated voltage for surge voltage class / pollution degree II/2	400 V
Rated voltage for surge voltage class / pollution degree III/2	320 V	Rated voltage for surge voltage class / pollution degree III/3	250 V
Rated impulse voltage for surge voltage class/ pollution degree II/2	4000 V	Rated impulse voltage for surge voltage class/ pollution degree III/2	4 kV
Rated impulse voltage for surge voltage class/ contamination degree III/3	4 kV	Short-time withstand current resistance	3 x 1s with 120 A

Rated data acc. to CSA

Institute (CSA)	CSA	Certificate No. (CSA)	200039-1121690
Rated voltage (Use group B / CSA)	300 V	Rated voltage (Use group D / CSA)	300 V
Rated current (Use group D / CSA)	10 A	Wire cross-section, AWG, min.	AWG 26
Wire cross-section, AWG, max.	AWG 12	Reference to approval values	Specifications are maximum values, details - see approval certificate.

Rated data acc. to UL 1059

Institute (cURus)	CURUS	Certificate No. (cURus)	E60693
Rated voltage (Use group B / UL 1059)	300 V	Rated voltage (Use group D / UL 1059)	300 V
Rated current (Use group B / UL 1059)	18.5 A	Rated current (Use group D / UL 1059)	10 A
Wire cross-section, AWG, min.	AWG 26	Wire cross-section, AWG, max.	AWG 12
Reference to approval values	Specifications are maximum values, details - see approval certificate.		

Packing

Packaging	Box	VPE length	351.00 mm
VPE width	136.00 mm	VPE height	38.00 mm

Type tests

Test: Durability of markings	Standard	DIN EN 61984 section 7.3.2 / 09.02 taking pattern from DIN EN 60068-2-70 / 07.96
	Test	mark of origin, type identification, pitch, type of material, date clock
	Evaluation	available
	Test	durability
Test: Misengagement (Non-interchangeability)	Standard	DIN EN 61984 section 6.3 and 6.9.1 / 09.02, DIN EN 60512-13-5 / 11.08
	Test	180° turned with coding elements
	Evaluation	passed
	Test	visual examination
Test: Clampable cross section	Evaluation	passed
	Standard	DIN EN 60999-1 section 7 and 9.1 / 12.00, DIN EN 60947-1 section 8.2.4.5.1 / 04.08
	Conductor type	Type of conductor solid 0.2 mm ² and conductor cross-section

Technical data

Evaluation	passed	
Requirement	≥20 N	
Conductor type	Type of conductor and conductor cross-section	H05V-K0.5
	Type of conductor and conductor cross-section	H05V-U0.5
Evaluation	passed	
Requirement	≥50 N	
Conductor type	Type of conductor and conductor cross-section	H07V-U2.5
	Type of conductor and conductor cross-section	H07V-K2.5
Evaluation	passed	
Requirement	≥60 N	
Conductor type	Type of conductor and conductor cross-section	AWG 12/1
	Type of conductor and conductor cross-section	AWG 12/19
Evaluation	passed	

Important note

IPC conformity Conformity: The products are developed, manufactured and delivered according international recognized standards and norms and comply with the assured properties in the data sheet resp. fulfill decorative properties in accordance with IPC-A-610 "Class 2". Further claims on the products can be evaluated on request.

- Notes
- Additional variants on request
 - Gold-plated contact surfaces on request
 - Rated current related to rated cross-section & min. No. of poles.
 - Wire end ferrule without plastic collar to DIN 46228/1
 - Wire end ferrule with plastic collar to DIN 46228/4
 - P on drawing = pitch
 - Crimping shape "A" for wire end ferrules with PZ 6/5 crimping tool recommended.
 - The test point can only be used as potential-pickup point.
 - In accordance with IEC 61984, OMNIMATE-connectors are connectors without breaking capacity (COC). During designated use, connectors are not allowed to be engaged or disengaged when live or under load
 - Long term storage of the product with average temperature of 50 °C and maximum humidity 70%, 36 months

Classifications

ETIM 8.0	EC002638	ETIM 9.0	EC002638
ETIM 10.0	EC002638	ECLASS 14.0	27-46-02-02
ECLASS 15.0	27-46-02-02		

BLF 5.08HC/09/180 SN BK BX

Weidmüller Interface GmbH & Co. KG
 Klingenbergstraße 26
 D-32758 Detmold
 Germany

www.weidmueller.com

Drawings

Product image

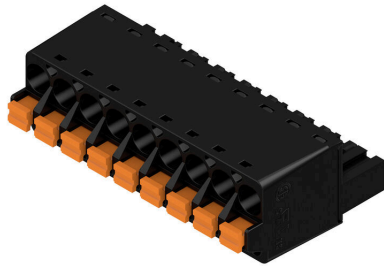

Dimensional drawing



Graph



Graph



Uncompromising functionality High vibration resistance

Drawings

Product benefits



Solid PUSH IN contact Safe and durable

Product benefits



Cost-effective wiring Quick and intuitive operation

Product benefits



Wide clamping range Tool-free wire connection

BLF 5.08HC/09/180 SN BK BX

Weidmüller Interface GmbH & Co. KG
 Klingenbergstraße 26
 D-32758 Detmold
 Germany

www.weidmueller.com

Accessories

Coding elements



Only connects what is supposed to be connected: the right connection at the right place.
 Coding elements and locking devices clearly assign connecting elements during the manufacturing process and operation
 The coding elements and locking devices are inserted prior to assembly or during the cable assembly phase.
 The Weidmüller alternative: configure online using the variant configurator to precode prior to delivery.
 Incorrect assembly on the circuit board and incorrect plugging of connecting elements is no longer possible.
 The advantage: no troubleshooting during manufacture and no operational errors by the user.

General ordering data

Type	BLZ/SL KO BK BX	Version
Order No.	1545710000	PCB plug-in connector, Accessories, Coding element, black, Number
GTIN (EAN)	4008190087142	of poles: 1
Qty.	50 ST	
Type	BLZ/SL KO OR BX	Version
Order No.	1573010000	PCB plug-in connector, Accessories, Coding element, orange, Number
GTIN (EAN)	4008190048396	of poles: 1
Qty.	100 ST	

Slotted screwdriver



Slotted screwdriver with rounded blade SD DIN 5265, ISO 2380/2, output to DIN 5264, ISO 2380/1.
 ChromTop tip, SoftFinish grip

General ordering data

Type	SDS 0.6X3.5X100	Version
Order No.	2749340000	Screwdriver, Blade width (B): 3.5 mm, Blade length: 100 mm, Blade
GTIN (EAN)	4050118895568	thickness (A): 0.6 mm
Qty.	1 ST	
Type	SDS 0.6X3.5X200	Version
Order No.	9010110000	Screwdriver, Screwdriver
GTIN (EAN)	4032248300754	
Qty.	1 ST	
Type	SDIS 0.6X3.5X100	Version
Order No.	2749810000	Screwdriver, Blade width (B): 3.5 mm, Blade length: 100 mm, Blade
GTIN (EAN)	4050118897012	thickness (A): 0.6 mm
Qty.	1 ST	

BLF 5.08HC/09/180 SN BK BX

Weidmüller Interface GmbH & Co. KG
 Klingenbergstraße 26
 D-32758 Detmold
 Germany

www.weidmueller.com

Accessories

Strain reliefs



For frequent load changes: the "trailer coupling" for plug-in connectors.

The strain relief can do more than just relieve the strain on conductors:

Simply clip onto the plug and

- bundle conductors
- guide cables
- use as a connection and disconnection aid

No damage to the connecting points, clear, tidy wiring and easy to handle.

User advantages: permanent heavy-duty connections for harsh industrial environments and convenient operation ensure improved system availability.

General ordering data

Type	BLF/SLF 5.08 ZE06 BK	Version
Order No.	2525850000	PCB plug-in connector, Accessories, Strain relief, black, Number of
GTIN (EAN)	4050118537116	poles: 6
Qty.	50 ST	
Type	BLF/SLF 5.08 ZE06 OR	Version
Order No.	2525780000	PCB plug-in connector, Accessories, Strain relief, orange, Number of
GTIN (EAN)	4050118536881	poles: 6
Qty.	50 ST	

BLF 5.08HC/09/180 SN BK BX

Weidmüller Interface GmbH & Co. KG
 Klingenbergstraße 26
 D-32758 Detmold
 Germany

www.weidmueller.com

Counterpart

SLDF 5.08



Male connector for through-panel mounting with optional locking function. Internal connection as flat-blade or solder connection. These male connectors provide space for labelling and can be coded.

General ordering data

Type	SLDF 5.08 L/F 9 SN OR BX	Version
Order No.	1599200000	PCB plug-in connector, male header, 5.08 mm, Number of poles: 9,
GTIN (EAN)	4008190084387	180°, Flat-blade connection, Solder connection, Box
Qty.	24 ST	

SL 5.08/135



Male connectors with 135° outlet direction. The solder pin length is optimised for wave flow soldering. The pin headers provide space for labelling and can be coded.

General ordering data

Type	SL 5.08/09/135 3.2SN OR...	Version
Order No.	1603130000	PCB plug-in connector, male header, open side, THT solder
GTIN (EAN)	4008190044299	connection, 5.08 mm, Number of poles: 9, 135°, Solder pin length (l):
Qty.	50 ST	3.2 mm, tinned, orange, Box

SL 5.08/135B



Male connectors with 135° outlet direction. The solder pin length is optimised for wave flow soldering. The pin headers provide space for labelling and can be coded.

General ordering data

Type	SL 5.08/09/135B 3.2SN O...	Version
Order No.	1605600000	PCB plug-in connector, male header, Dovetails for fixing blocks, THT
GTIN (EAN)	4008190142940	solder connection, 5.08 mm, Number of poles: 9, 135°, Solder pin
Qty.	50 ST	length (l): 3.2 mm, tinned, orange, Box

BLF 5.08HC/09/180 SN BK BX

Weidmüller Interface GmbH & Co. KG
 Klingenbergstraße 26
 D-32758 Detmold
 Germany

www.weidmueller.com

Counterpart

SL 5.08/180



Male connectors with straight outlet direction. The solder pin length is optimised for wave flow soldering. The pin headers provide space for labelling and can be coded.

General ordering data

Type	SL 5.08/09/180 3.2SN OR...	Version
Order No.	1517960000	PCB plug-in connector, male header, open side, THT solder
GTIN (EAN)	4008190137090	connection, 5.08 mm, Number of poles: 9, 180°, Solder pin length (l):
Qty.	50 ST	3.2 mm, tinned, orange, Box

SL 5.08/180B



Male connectors with straight outlet direction. The solder pin length is optimised for wave flow soldering. The pin headers provide space for labelling and can be coded.

General ordering data

Type	SL 5.08/09/180B 3.2SN O...	Version
Order No.	1520260000	PCB plug-in connector, male header, Dovetails for fixing blocks, THT
GTIN (EAN)	4008190120412	solder connection, 5.08 mm, Number of poles: 9, 180°, Solder pin
Qty.	50 ST	length (l): 3.2 mm, tinned, orange, Box

SL 5.08/90



Male connectors with 90° outlet direction. The solder pin length is optimised for wave flow soldering. The pin headers provide space for labelling and can be coded.

General ordering data

Type	SL 5.08/09/90 3.2SN OR ...	Version
Order No.	1508760000	PCB plug-in connector, male header, open side, THT solder
GTIN (EAN)	4008190152833	connection, 5.08 mm, Number of poles: 9, 90°, Solder pin length (l):
Qty.	50 ST	3.2 mm, tinned, orange, Box

BLF 5.08HC/09/180 SN BK BX

Weidmüller Interface GmbH & Co. KG
 Klingenbergstraße 26
 D-32758 Detmold
 Germany

Counterpart

www.weidmueller.com

SL 5.08/90B



Male connectors with 90° outlet direction. The solder pin length is optimised for wave flow soldering. The pin headers provide space for labelling and can be coded.

General ordering data

Type	SL 5.08/09/90B 3.2SN OR...	Version
Order No.	1511060000	PCB plug-in connector, male header, Dovetails for fixing blocks, THT
GTIN (EAN)	4008190135058	solder connection, 5.08 mm, Number of poles: 9, 90°, Solder pin
Qty.	50 ST	length (l): 3.2 mm, tinned, orange, Box

SL 5.08HC/180



Pin headers in glass-fibre-reinforced plastic with straight wire outlet; optimised for wave soldering. The flange variant (F) can be screwed onto the respective counter piece or the circuit board. There is no need for an extra screw to connect the circuit board when the solder flange (LF) version is used. This also protects the solder points from mechanical strain. All pin headers can be manually coded or ordered pre-coded. HC = High Current.

General ordering data

Type	SL 5.08HC/09/180 3.2SN ...	Version
Order No.	1148270000	PCB plug-in connector, male header, open side, THT solder
GTIN (EAN)	4032248934379	connection, 5.08 mm, Number of poles: 9, 180°, Solder pin length (l):
Qty.	50 ST	3.2 mm, tinned, black, Box
Type	SL 5.08HC/09/180 3.2SN ...	Version
Order No.	1146510000	PCB plug-in connector, male header, open side, THT solder
GTIN (EAN)	4032248933112	connection, 5.08 mm, Number of poles: 9, 180°, Solder pin length (l):
Qty.	50 ST	3.2 mm, tinned, orange, Box

SL 5.08HC/180B



Pin headers in glass-fibre-reinforced plastic with straight wire outlet; optimised for wave soldering. The flange variant (F) can be screwed onto the respective counter piece or the circuit board. There is no need for an extra screw to connect the circuit board when the solder flange (LF) version is used. This also protects the solder points from mechanical strain. All pin headers can be manually coded or ordered pre-coded. HC = High Current.

BLF 5.08HC/09/180 SN BK BX

Weidmüller Interface GmbH & Co. KG
Klingenbergstraße 26
D-32758 Detmold
Germany

Counterpart

www.weidmueller.com

General ordering data

Type	SL 5.08HC/09/180B 3.2SN...	Version
Order No.	1149630000	PCB plug-in connector, male header, Dovetails for fixing blocks, THT
GTIN (EAN)	4032248934843	solder connection, 5.08 mm, Number of poles: 9, 180°, Solder pin
Qty.	50 ST	length (l): 3.2 mm, tinned, black, Box
Type	SL 5.08HC/09/180B 3.2SN...	Version
Order No.	1147540000	PCB plug-in connector, male header, Dovetails for fixing blocks, THT
GTIN (EAN)	4032248108251	solder connection, 5.08 mm, Number of poles: 9, 180°, Solder pin
Qty.	50 ST	length (l): 3.2 mm, tinned, orange, Box

SL 5.08HC/180G



Pin headers in glass-fibre-reinforced plastic with straight wire outlet; optimised for wave soldering. The flange variant (F) can be screwed onto the respective counter piece or the circuit board. There is no need for an extra screw to connect the circuit board when the solder flange (LF) version is used. This also protects the solder points from mechanical strain. All pin headers can be manually coded or ordered pre-coded. HC = High Current.

General ordering data

Type	SL 5.08HC/09/180G 3.2SN...	Version
Order No.	1148870000	PCB plug-in connector, male header, closed side, THT solder
GTIN (EAN)	4032248934805	connection, 5.08 mm, Number of poles: 9, 180°, Solder pin length (l):
Qty.	50 ST	3.2 mm, tinned, black, Box
Type	SL 5.08HC/09/180G 3.2SN...	Version
Order No.	1146890000	PCB plug-in connector, male header, closed side, THT solder
GTIN (EAN)	4032248933884	connection, 5.08 mm, Number of poles: 9, 180°, Solder pin length (l):
Qty.	50 ST	3.2 mm, tinned, orange, Box

SL 5.08HC/90



Pin headers made from glass-fibre-reinforced plastic with 90° wire outlet; optimised for wave soldering. The flange variant (F) can be screwed onto the respective counter piece or the circuit board. There is no need for an extra screw to connect the circuit board when the solder flange (LF) version is used. This also protects the solder points from mechanical strain. All pin headers can be manually coded or ordered pre-coded. HC = High Current.

General ordering data

Type	SL 5.08HC/09/90 3.2SN B...	Version
Order No.	1155100000	PCB plug-in connector, male header, open side, THT solder
GTIN (EAN)	4050118050745	connection, 5.08 mm, Number of poles: 9, 90°, Solder pin length (l):
Qty.	50 ST	3.2 mm, tinned, black, Box
Type	SL 5.08HC/09/90 3.2SN O...	Version
Order No.	1146880000	PCB plug-in connector, male header, open side, THT solder
GTIN (EAN)	4050118051438	connection, 5.08 mm, Number of poles: 9, 90°, Solder pin length (l):
Qty.	50 ST	3.2 mm, tinned, orange, Box

BLF 5.08HC/09/180 SN BK BX

Weidmüller Interface GmbH & Co. KG
 Klingenbergstraße 26
 D-32758 Detmold
 Germany

Counterpart

www.weidmueller.com

SL 5.08HC/90B



Pin headers made from glass-fibre-reinforced plastic with 90° wire outlet; optimised for wave soldering. The flange variant (F) can be screwed onto the respective counter piece or the circuit board. There is no need for an extra screw to connect the circuit board when the solder flange (LF) version is used. This also protects the solder points from mechanical strain. All pin headers can be manually coded or ordered pre-coded. HC = High Current.

General ordering data

Type	SL 5.08HC/09/90B 3.2SN ...	Version
Order No.	1155650000	PCB plug-in connector, male header, Dovetails for fixing blocks, THT
GTIN (EAN)	4050118050288	solder connection, 5.08 mm, Number of poles: 9, 90°, Solder pin
Qty.	50 ST	length (l): 3.2 mm, tinned, black, Box
Type	SL 5.08HC/09/90B 3.2SN ...	Version
Order No.	1154840000	PCB plug-in connector, male header, Dovetails for fixing blocks, THT
GTIN (EAN)	4050118050974	solder connection, 5.08 mm, Number of poles: 9, 90°, Solder pin
Qty.	50 ST	length (l): 3.2 mm, tinned, orange, Box

SLDV 5.08/180



Pin headers with solder pin length optimised for wave flow soldering. The male connectors provide space for labelling and can be coded. HC = High Current.

General ordering data

Type	SLD 5.08V/18/180 3.2SN ...	Version
Order No.	1725720000	PCB plug-in connector, male header, open side, THT solder
GTIN (EAN)	4032248062010	connection, 5.08 mm, Number of poles: 18, 180°, Solder pin length
Qty.	20 ST	(l): 3.2 mm, tinned, orange, Box

SLDV 5.08/180B



Pin headers with solder pin length optimised for wave flow soldering. The male connectors provide space for labelling and can be coded. HC = High Current.

BLF 5.08HC/09/180 SN BK BX

Weidmüller Interface GmbH & Co. KG
 Klingenbergstraße 26
 D-32758 Detmold
 Germany

www.weidmueller.com

Counterpart

General ordering data

Type	SLD 5.08V/18/180B 3.2SN...	Version
Order No.	1726810000	PCB plug-in connector, male header, Dovetails for fixing blocks, THT
GTIN (EAN)	4032248062690	solder connection, 5.08 mm, Number of poles: 18, 180°, Solder pin
Qty.	20 ST	length (l): 3.2 mm, tinned, orange, Box

SLDV 5.08/90



Pin headers with solder pin length optimised for wave flow soldering. The male connectors provide space for labelling and can be coded. HC = High Current.

General ordering data

Type	SLD 5.08V/18/90 3.2 SN ...	Version
Order No.	1725240000	PCB plug-in connector, male header, open side, THT solder
GTIN (EAN)	4032248060641	connection, 5.08 mm, Number of poles: 18, 90°, Solder pin length (l):
Qty.	20 ST	3.2 mm, tinned, orange, Box

SL-SMT 5.08/180 Box

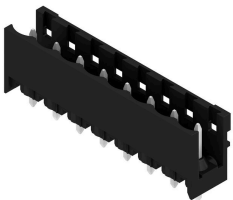

High-temperature-resistant, straight, open pin header. Packed in box or tape. On tape and with 1.5 mm solder pin, optimised for automatic assembly. 3.2 mm solder pin suitable for reflow and wave soldering. The pin headers provide space for labelling and can be coded. HC = High Current.

General ordering data

Type	SL-SMT 5.08HC/09/180 3....	Version
Order No.	1838050000	PCB plug-in connector, male header, open side, THT/THR solder
GTIN (EAN)	4032248348114	connection, 5.08 mm, Number of poles: 9, 180°, Solder pin length (l):
Qty.	50 ST	3.2 mm, tinned, black, Box

BLF 5.08HC/09/180 SN BK BX

Weidmüller Interface GmbH & Co. KG
 Klingenbergstraße 26
 D-32758 Detmold
 Germany

Counterpart

www.weidmueller.com

SL-SMT 5.08/180G Box



High-temperature-resistant pin header, packed in box or tape. On tape, with 1.5 mm solder pin, optimised for automatic assembly. 3.2 mm solder pin suitable for reflow and wave soldering. The pin headers provide space for labelling and can be coded. HC = High Current.

General ordering data

Type	SL-SMT 5.08HC/09/180G 1...	Version
Order No.	1775992001	PCB plug-in connector, male header, closed side, THT/THR solder connection, 5.08 mm, Number of poles: 9, 180°, Solder pin length (l):
GTIN (EAN)	4032248158980	
Qty.	50 ST	1.5 mm, tinned, black, Box
Type	SL-SMT 5.08HC/09/180G 3...	Version
Order No.	1838280000	PCB plug-in connector, male header, closed side, THT/THR solder connection, 5.08 mm, Number of poles: 9, 180°, Solder pin length (l):
GTIN (EAN)	4032248348343	
Qty.	50 ST	3.2 mm, tinned, black, Box

SL-SMT 5.08HC/90 Box



High-temperature-resistant, 90° angled, open male header. Packed in box or tape. On tape, with 1.5 mm solder pin, optimised for automatic assembly. 3.2 mm solder pin suitable for reflow and wave soldering. The pin headers provide space for labelling and can be coded. HC = High Current.

General ordering data

Type	SL-SMT 5.08HC/09/90 1.5...	Version
Order No.	1774832001	PCB plug-in connector, male header, open side, THT/THR solder connection, 5.08 mm, Number of poles: 9, 90°, Solder pin length (l):
GTIN (EAN)	4032248155873	
Qty.	50 ST	1.5 mm, tinned, black, Box
Type	SL-SMT 5.08HC/09/90 3.2...	Version
Order No.	1780020000	PCB plug-in connector, male header, open side, THT/THR solder connection, 5.08 mm, Number of poles: 9, 90°, Solder pin length (l):
GTIN (EAN)	4032248165346	
Qty.	50 ST	3.2 mm, tinned, black, Box

BLF 5.08HC/09/180 SN BK BX

Weidmüller Interface GmbH & Co. KG
 Klingenbergstraße 26
 D-32758 Detmold
 Germany

Counterpart

www.weidmueller.com

SL-SMT 5.08HC/90G Box



High-temperature-resistant pin header, packed in box or tape. On tape, with 1.5 mm solder pin, optimised for automatic assembly. 3.2 mm solder pin suitable for reflow and wave soldering. The pin headers provide space for labelling and can be coded. HC = High Current.

General ordering data

Type	SL-SMT 5.08HC/09/90G 1...	Version
Order No.	1775072001	PCB plug-in connector, male header, closed side, THT/THR solder connection, 5.08 mm, Number of poles: 9, 90°, Solder pin length (l):
GTIN (EAN)	4032248156542	1.5 mm, tinned, black, Box
Qty.	50 ST	
Type	SL-SMT 5.08HC/09/90G 3...	Version
Order No.	1780250000	PCB plug-in connector, male header, closed side, THT/THR solder connection, 5.08 mm, Number of poles: 9, 90°, Solder pin length (l):
GTIN (EAN)	4032248165575	3.2 mm, tinned, black, Box
Qty.	50 ST	

SLF 5.08/180 SN

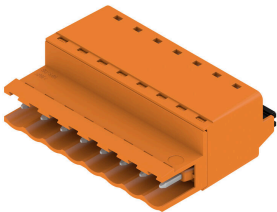

Male plug with PUSH IN wire connection and straight outlet direction, when used with BLF 5.08HC as wire-to-wire application for panel feed-through The male plugs provide space for labelling and can be coded.

General ordering data

Type	SLF 5.08/09/180 SN BK BX	Version
Order No.	1335690000	PCB plug-in connector, male plug, 5.08 mm, Number of poles: 9,
GTIN (EAN)	4050118139129	180°, PUSH IN with actuator, Clamping range, max. : 3.31 mm², Box
Qty.	36 ST	
Type	SLF 5.08/09/180 SN OR BX	Version
Order No.	1335400000	PCB plug-in connector, male plug, 5.08 mm, Number of poles: 9,
GTIN (EAN)	4050118138641	180°, PUSH IN with actuator, Clamping range, max. : 3.31 mm², Box
Qty.	36 ST	

BLF 5.08HC/09/180 SN BK BX

Weidmüller Interface GmbH & Co. KG
Klingenbergstraße 26
D-32758 Detmold
Germany

www.weidmueller.com

Counterpart

SLF 5.08/180B SN



Male plug with PUSH IN wire connection and straight outlet direction, when used with BLF 5.08HC as wire-to-wire application for panel feed-through. The male plugs provide space for labelling and can be coded.

General ordering data

Type	SLF 5.08/09/180B SN BK ...	Version
Order No.	1335920000	PCB plug-in connector, male plug, 5.08 mm, Number of poles: 9,
GTIN (EAN)	4050118140187	180°, PUSH IN with actuator, Clamping range, max. : 3.31 mm ² , Box
Qty.	36 ST	
Type	SLF 5.08/09/180B SN OR ...	Version
Order No.	1335520000	PCB plug-in connector, male plug, 5.08 mm, Number of poles: 9,
GTIN (EAN)	4050118138788	180°, PUSH IN with actuator, Clamping range, max. : 3.31 mm ² , Box
Qty.	36 ST	

SLF 5.08/180DF SN



Male plug with PUSH IN wire connection and straight outlet direction, when used with BLF 5.08HC as wire-to-wire application for panel feed-through. The male plugs provide space for labelling and can be coded.

General ordering data

Type	SLF 5.08/09/180DF SN OR...	Version
Order No.	1353670000	PCB plug-in connector, male plug, 5.08 mm, Number of poles: 9,
GTIN (EAN)	4050118156515	180°, PUSH IN with actuator, Clamping range, max. : 3.31 mm ² , Box
Qty.	24 ST	

SLT 5.08/180DF SN



Male plugs with screw TOP wire connection. The male plug provides space for labelling and can be coded.

BLF 5.08HC/09/180 SN BK BX

Weidmüller Interface GmbH & Co. KG
 Klingenbergstraße 26
 D-32758 Detmold
 Germany

www.weidmueller.com

Counterpart

General ordering data

Type	SLT 5.08/09/180DF SN OR...	Version
Order No.	1353440000	PCB plug-in connector, male plug, 5.08 mm, Number of poles: 9,
GTIN (EAN)	4050118155990	180°, TOP connection, Clamping range, max.: 2.5 mm ² , Box
Qty.	24 ST	

SLT 5.08B

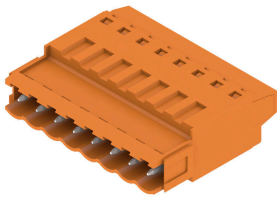

Male plugs with screw TOP wire connection. The male plug provides space for labelling and can be coded.

General ordering data

Type	SLT 5.08/09/180B SN OR ...	Version
Order No.	1611780000	PCB plug-in connector, male plug, 5.08 mm, Number of poles: 9,
GTIN (EAN)	4008190192662	180°, TOP connection, Clamping range, max.: 2.5 mm ² , Box
Qty.	50 ST	

SLS 5.08/180 SN

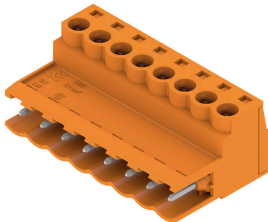

Male plugs with clamping-yoke screw wire-connect system. The male plugs provide space for labelling and can be coded.

General ordering data

Type	SLS 5.08/09/180 SN OR BX	Version
Order No.	1627160000	PCB plug-in connector, male plug, 5.08 mm, Number of poles: 9,
GTIN (EAN)	4008190199678	180°, Clamping yoke connection, Clamping range, max.: 3.31 mm ² ,
Qty.	36 ST	Box

BLF 5.08HC/09/180 SN BK BX

Weidmüller Interface GmbH & Co. KG
Klingenbergstraße 26
D-32758 Detmold
Germany

Counterpart

www.weidmueller.com

SLS 5.08/180B



Male plugs with clamping-yoke screw wire-connect system. The male plugs provide space for labelling and can be coded.

General ordering data

Type	SLS 5.08/09/180B SN OR ...	Version
Order No.	1627310000	PCB plug-in connector, male plug, 5.08 mm, Number of poles: 9,
GTIN (EAN)	4008190199821	180°, Clamping yoke connection, Clamping range, max. : 3.31 mm²,
Qty.	36 ST	Box