

FP BOX ON/OFF

Weidmüller Interface GmbH & Co. KG
 Klingenbergstraße 26
 D-32758 Detmold
 Germany

www.weidmueller.com



The FieldPower® power distributors support error-free installation in an extremely short space of time. Branches and functions integrated in the cover can simply be plugged in. Robust with high protection degree.

General ordering data

Version	FieldPower® power distribution box, 3-phase AC, IP65, in closed state, glass-fibre reinforced polycarbonate, Insulation displacement connection (IDC), PUSH IN, Maintenance switch
Order No.	1003260000
Type	FP BOX ON/OFF
GTIN (EAN)	4032248698967
Qty.	1 items

FP BOX ON/OFF

Weidmüller Interface GmbH & Co. KG
 Klingenbergstraße 26
 D-32758 Detmold
 Germany

www.weidmueller.com

Technical data

Approvals

Approvals



ROHS	Conform
UL File Number Search	UL Website
Certificate no. (cULus)	E318973

Dimensions and weights

Depth	165 mm	Depth (inches)	6.4961 inch
Height	181 mm	Height (inches)	7.126 inch
Width	104 mm	Width (inches)	4.0945 inch
Net weight	964.48 g		

Temperatures

Storage temperature	-30 °C...55 °C	Operating temperature	-30 °C...45 °C
---------------------	----------------	-----------------------	----------------

Environmental Product Compliance

RoHS Compliance Status	Compliant with exemption
RoHS Exemption (if applicable/known)	6c
REACH SVHC	Lead 7439-92-1, Potassium perfluorobutane sulfonate 29420-49-3
SCIP	7645f3b1-6db9-495d-9e21-ab1d894aff05

Clamping capacity

Connection data - contact element Branch / Feed-in	Wire connection method	PUSH IN
	Blade size of operating tool	0.6 x 3.5 mm
	Stripping length	14.00 mm
	Number of poles	5
	Conductor connection cross-section, solid, max.	6 mm ²
	Conductor connection cross-section, solid, min.	0.50 mm ²
	Conductor connection cross-section, stranded, max.	6.00 mm ²
	Conductor connection cross-section, stranded, min.	0.50 mm ²
	Conductor connection cross-section, finely stranded, max.	10.00 mm ²
	Conductor connection cross-section, finely stranded, min.	0.50 mm ²
	Conductor connection cross-section, finest stranded, max.	6.00 mm ²
	Conductor connection cross-section, finest stranded, min.	0.50 mm ²
	Connection data - contact element power bus	Wire connection method
Blade size of operating tool		0.6 x 3.5 mm
Number of poles		5
Conductor connection cross-section, solid, max.		6 mm ²
Conductor connection cross-section, solid, min.		1.50 mm ²
Conductor connection cross-section, stranded, max.		6.00 mm ²
Conductor connection cross-section, stranded, min.	2.50 mm ²	

FP BOX ON/OFF

Weidmüller Interface GmbH & Co. KG

Klingenbergstraße 26
D-32758 Detmold
Germany

www.weidmueller.com

Technical data

Conductor connection cross-section, finely stranded, max.	6.00 mm ²
Conductor connection cross-section, finely stranded, min.	2.50 mm ²

General data

Insulating material	Polycarbonate	Enclosure material	glass-fibre reinforced polycarbonate
Silicone	No	Colour	black
Protection degree	IP65, in closed state	UL 94 flammability rating	5VA
Torque for lid screws lockable	2 Nm Yes	Lid attachment	TX20 screws
Installation advice	Lid screws included	Type of mounting	Screw mounting, Fixing lugs
Can be coded	Yes, Coded on PE	Function	Maintenance switch
Number of poles	5	Voltage type	3-phase AC
Wire connection method	Insulation displacement connection (IDC), PUSH IN	Number of connections / pole	1
		Type of connection, signal	M12, A-coded

Rated data acc. to IEC

Rated data acc. to IEC for plug-in connector	Voltage type	AC
	Number of phases	3
	Standard	IEC 60947-7-1, IEC 60947-7-2, IEC 61984
	Rated voltage	690 V
	Rated impulse withstand voltage	8.00 kV
	Rated current (3 loaded poles)	32 A
Rated data acc. to IEC for contact element	Rated current (4 loaded poles)	25 A
	Voltage type	AC
	Number of phases	3
	Standard	IEC 60947-7-1, IEC 60947-7-2
	Rated voltage	800 V
	Rated impulse withstand voltage	8.00 kV
	Rated current (3 loaded poles)	41 A
	Rated current (4 loaded poles)	25 A

Rated data acc. to UL

Standards	UL 508	
Rated data acc. to UL for contact element	Standard	UL 1059
	Note	for use with UL-listed TC-ER cables
	Conductor connection cross-section, AWG, max.	AWG 10
	Conductor connection cross-section, AWG, min.	AWG 14
	Rated voltage	600 V
	Rated current	30 A
Rated data acc. to UL for plug-in connector	Standard	UL 1059
	Note	for use with UL-listed TC-ER cables
	Conductor connection cross-section, AWG, max.	AWG 12
	Conductor connection cross-section, AWG, min.	AWG 16
	Rated voltage	600 V
	Rated current	20 A

FP BOX ON/OFF

Weidmüller Interface GmbH & Co. KG
 Klingenbergstraße 26
 D-32758 Detmold
 Germany

www.weidmueller.com

Technical data

Technical data Switch

Terminals - torque	0.8 Nm	Wire connection cross section AWG, max.	AWG 8
Switch type	ABB OT16FT3	Operating voltage	690 V
Wire connection cross section AWG, min.	AWG 18	Pollution severity	3
Power rating AC-23A	7.5 kW	Rated current AC-23A	16 A
auxiliary contact	ABB OA1G10	Switch according to standard	IEC 60947-3
Clamping range, plug, min.	0.75 mm ²	Clamping range, plug, max.	10 mm ²
Rated short-term current resistance ICW 500 A rms for 1 Second			

Classifications

ETIM 8.0	EC000214	ETIM 9.0	EC000214
ETIM 10.0	EC000214	ECLASS 14.0	27-14-24-09
ECLASS 15.0	27-14-24-09		

FP BOX ON/OFF

Weidmüller Interface GmbH & Co. KG
 Klingenbergstraße 26
 D-32758 Detmold
 Germany

www.weidmueller.com

Drawings

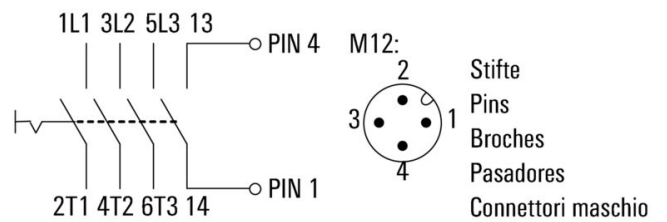
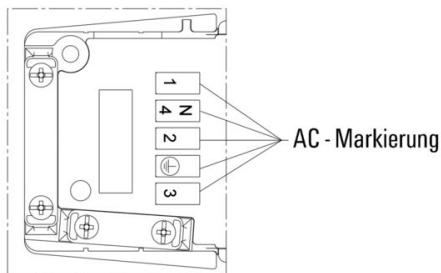
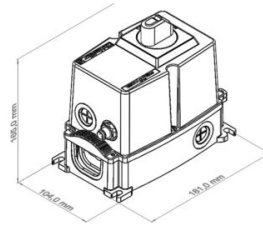
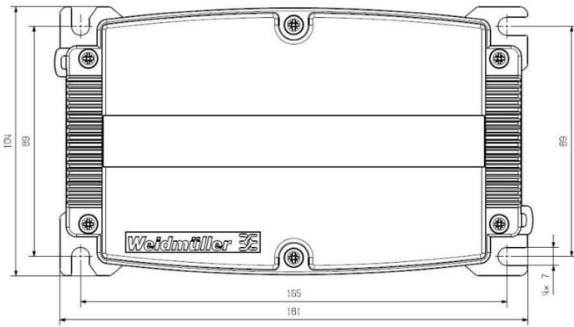

FP BOX ON/OFF

Weidmüller Interface GmbH & Co. KG

Klingenbergstraße 26

D-32758 Detmold

Germany

Accessories

www.weidmueller.com

Seals

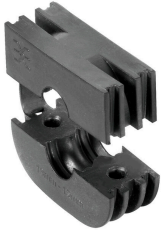

Intelligent cabling solutions can save you valuable time and money.

The FieldPower® modular system contains the right solution for every cabling task.

Foldable seals for the use of pre-assembled cables
Seals available with M16 and M20 connection thread
Integration of operating and signalling devices into the seal possible

General ordering data

Type	RKDG D9 PT6	Version
Order No.	4329610000	Field Power® sealing insert, Foldable seal, IP65 with corresponding
GTIN (EAN)	4032248668687	housing, IP65, with corresponding enclosure, EPDM
Qty.	10 ST	
Type	RKDG D11 PT6	Version
Order No.	4323210000	Field Power® sealing insert, Foldable seal, IP65 with corresponding
GTIN (EAN)	4032248641215	housing, IP65, with corresponding enclosure, EPDM
Qty.	10 ST	
Type	RKDG D13 PT6	Version
Order No.	4323230000	Field Power® sealing insert, Foldable seal, IP65 with corresponding
GTIN (EAN)	4032248641239	housing, IP65, with corresponding enclosure, EPDM
Qty.	10 ST	
Type	RKDG D15 PT6	Version
Order No.	4323220000	Field Power® sealing insert, Foldable seal, IP65 with corresponding
GTIN (EAN)	4032248641222	housing, IP65, with corresponding enclosure, EPDM
Qty.	10 ST	
Type	RKDG D17 PT6	Version
Order No.	4324010000	Field Power® sealing insert, Foldable seal, IP65 with corresponding
GTIN (EAN)	4032248641284	housing, IP65, with corresponding enclosure, EPDM
Qty.	10 ST	
Type	RKDG 2XD8.5 WG PT6	Version
Order No.	1114530000	Field Power® sealing insert, Seal, IP54, with corresponding
GTIN (EAN)	4032248892624	enclosure, EPDM
Qty.	10 ST	

Adapters

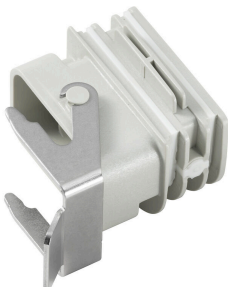

HQ adapter for FieldPower®

Tool-free installation like a FieldPower cable seal
Suitable for the HQ 4/2, HQ 8 and HQ 17 plug-in connector inserts

Optionally with lockable protective cover (protection against being switched on again, in accordance with EN 60204-1)

FP BOX ON/OFF

Weidmüller Interface GmbH & Co. KG
 Klingenbergstraße 26
 D-32758 Detmold
 Germany

www.weidmueller.com

Accessories

General ordering data

Type	BG ARGH HQP ALU PT6	Version
Order No.	1532200000	Adapter, Field Power® sealing insert, HQ adapter, IP65, with corresponding enclosure, Polycarbonate, glass fibre reinforced, lockable: No
GTIN (EAN)	4050118337433	
Qty.	1 ST	
Type	BG ARGH HQP ALU PT6 CS	Version
Order No.	1532210000	Adapter, Field Power® sealing insert, HQ adapter, IP65, with corresponding enclosure, Polycarbonate, glass fibre reinforced, lockable: Yes
GTIN (EAN)	4050118337600	
Qty.	1 ST	

Seals

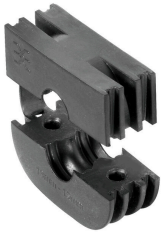

Intelligent cabling solutions can save you valuable time and money. The FieldPower® modular system contains the right solution for every cabling task. Foldable seals for the use of pre-assembled cables. Seals available with M16 and M20 connection thread. Integration of operating and signalling devices into the seal possible.

General ordering data

Type	DG D0 PT6	Version
Order No.	4323240000	Field Power® sealing insert, Blank seal, IP65, with corresponding enclosure, EPDM
GTIN (EAN)	4032248641246	
Qty.	10 ST	
Type	DG M16 PT6	Version
Order No.	2545540000	Field Power® sealing insert, Seal with connection thread, IP65, with corresponding enclosure, EPDM
GTIN (EAN)	4050118555523	
Qty.	1 ST	
Type	DG M20 PT6	Version
Order No.	2545550000	Field Power® sealing insert, Seal with connection thread, IP65, with corresponding enclosure, EPDM
GTIN (EAN)	4050118555530	
Qty.	1 ST	

Tools



Sheathing stripper for PVC cables

General ordering data

Type	AM 16	Version
Order No.	9204190000	Tools, Sheathing strippers
GTIN (EAN)	4032248608133	
Qty.	1 ST	

FP BOX ON/OFF

Weidmüller Interface GmbH & Co. KG
 Klingenbergstraße 26
 D-32758 Detmold
 Germany

www.weidmueller.com

Accessories

Type	AM 25	Version	
Order No.	9001540000	Tools, Sheathing strippers	
GTIN (EAN)	4008190138271		
Qty.	1 ST		

Slotted screwdriver



Slotted screwdriver with rounded blade SD DIN 5265, ISO 2380/2, output to DIN 5264, ISO 2380/1. ChromTop tip, SoftFinish grip

General ordering data

Type	SDS 0.6X3.5X100	Version	
Order No.	2749340000	Screwdriver, Blade width (B): 3.5 mm, Blade length: 100 mm, Blade thickness (A): 0.6 mm	
GTIN (EAN)	4050118895568		
Qty.	1 ST		

DMS PRO



Weidmüller torque screwdrivers have an ergonomic design and are therefore ideal for use with one hand. They can be used without causing fatigue in all installation positions. Apart from that, they incorporate an automatic torque limiter and have a good reproducibility accuracy.

General ordering data

Type	DMS PRO	Version	
Order No.	1479120000	Mounting tool	
GTIN (EAN)	4050118287011		
Qty.	1 ST		

FP BOX ON/OFF

Weidmüller Interface GmbH & Co. KG
 Klingenbergstraße 26
 D-32758 Detmold
 Germany

Accessories

www.weidmueller.com

Plastic lock nuts, grey



In addition to cable glands for a wide range of applications, the product portfolio is rounded off by plugs, pressure compensation elements, adaptors and the corresponding accessories such as locknuts, sealing rings, flat washers and earthing rings.

General ordering data

Type	SKMU M20 - K GR	Version	
Order No.	1772460000	SKMU PA (plastic locknut), Locknut, M 20, 6 mm, Polyamid 6 (PA6 -	
GTIN (EAN)	4032248130207	GF30)	
Qty.	100 ST		

IP68 version



In addition to the extensive range of enclosures, Weidmüller offers a variety of cable glands for a wide range of applications. The cable glands made of brass, plastic and stainless steel meet the most various IP protection classes to suit any industrial enclosure. Depending on the series of cable glands and the application, the cable glands are approved and tested according to VDE, UL, UR, cULus, DNV GL or EN 45545.

General ordering data

Type	VG M20 - K 68	Version	
Order No.	2811470000	VG K (standard plastic cable gland), Cable glands, straight, M 20, 10	
GTIN (EAN)	4064675292227	mm, OD min. 10 - OD max. 14 mm, IP54, IP66, IP67, IP68 - 5 bar (30	
Qty.	50 ST	min.), Polyamide 6	
Type	VG M20-1/K68	Version	
Order No.	1772300000	VG K (standard plastic cable gland), Cable glands, straight, M 20, 10	
GTIN (EAN)	4032248129966	mm, OD min. 6 - OD max. 12 mm, IP54, IP66, IP67, IP68 - 5 bar (30	
Qty.	50 ST	min.), Polyamide 6	

Accessories

Bits E6,3 - Torx®



The Weidmüller bits are standard bits which are highly popular with users thanks to their good quality, large range and efficiency. The computer-controlled hardening method enables Weidmüller to guarantee a consistently high standard of quality.

The high-quality raw materials used make it possible to reach torques far higher than any of those specified in the relevant DIN standards:

- DIN 5261 for PH/PZ bits,
- DIN 5263 for slotted bits,
- Camcar standard for TORX bits

That means a long life at high torques and hence ideal conditions for standard situations.

The benefits:

- Suitable for all types of screws. Because of their excellent hardness values of 59-61 HRC, they are suitable for use with both manual and power tools.
- Good wearing resistance and thus a long life expectancy.
- Optimum fit in all DIN screws means low wear and optimum torque transmission.
- Manufactured to meet professional quality criteria according to relevant ISO standards with a consistently high standard of quality.

General ordering data

Type	BIT E6,3 T20 X 150	Version	
Order No.	2821510000	Mounting tool	
GTIN (EAN)	4064675359050		
Qty.	5 ST		

Slotted screwdriver



Slotted screwdriver with rounded blade SD DIN 5265, ISO 2380/2, output to DIN 5264, ISO 2380/1. ChromTop tip, SoftFinish grip

General ordering data

Type	SDS 0.5X3.0X80	Version	
Order No.	2749330000	Screwdriver, Blade width (B): 3 mm, Blade length: 80 mm, Blade thickness (A): 0.5 mm	
GTIN (EAN)	4050118895551		
Qty.	1 ST		